

OmniEPDG

OmniEPDG (ePDG) WiFi (VoWiFi) EAP-AKA WiFi Diameter HSS GTP (PGW)

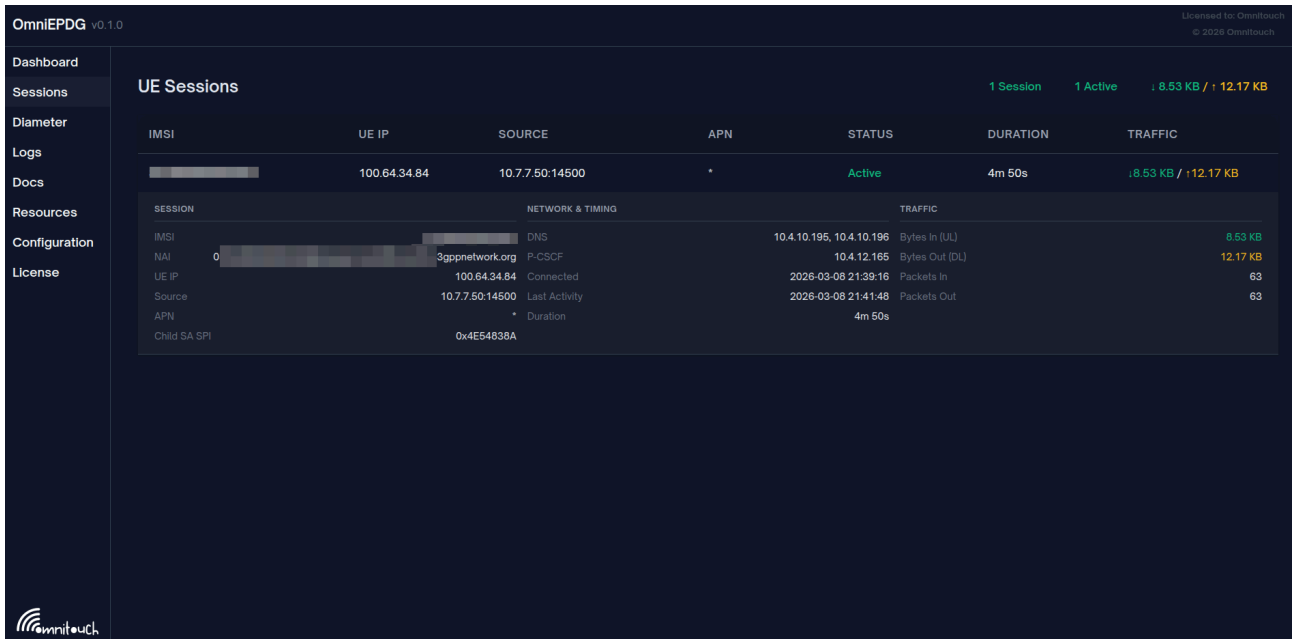

OmniEPDG

OmniEPDG

- **GTP** - GTPv2-C GTP-U PGW 3GPP
- **VPN** - IP Linux TUN PGW



- - UE
- - Diameter GTPv2-C GTP-U VPN
- - Diameter Web UI

GTP

OmniEPDG PGW GTPv2-C GTP-U Linux 3GPP EPC

UE → IPsec → OmniEPDG → GTPv2-C → GTP-U → PGW

HSS PGW

VPN

OmniEPDG IP Linux TUN tun_epdg PGW GTP Diameter SWx HSS

UE → IPsec → OmniEPDG → IP → TUN → Linux →

HSS PGW

skip_sar HSS HSS ePDG HSS

□□□□

□□	GTP □□	□□ VPN □□
3GPP □□	□	□□□□ skip_sar □□□□□□□□□□
□□ PGW	□	□
□□ HSS	□	□□□□□□□□
IP □□	□□ PGW	□□□□CIDR□
□□□□	GTP-U □□□□	Linux TUN + □□
HSS □□□□□□	□□PPR/PPA□	□
HSS □□	□□RTR/RTA□	□□□□ skip_sar □
PGW □□□□□□	□	□□□
□□□□	□	□
IPv6 / □□	□	□ IPv4

VPN

- **IP** - CIDR IPv4 IMSI
- **TUN** - Linux TUN tun_epdg UE
- **DNS** - PCO UE DNS
- **SAR** - HSS

- IP IMSI
- **GeoIP** - MaxMind GeoLite2
-
- **ESP** - RFC 4303 64

HSS (SWx Diameter)

- **(MAR/MAA)** - EAP-AKA
- **(SAR/SAA)** - APN
- **(PPR/PPA)** - HSS GTP
- **(RTR/RTA)** - HSS GTP

PGW GTP

S6b Diameter:

- **AA** (AAR/AAA) - PGW
- **(STR/STA)** - PGW
- **(RAR/RAA)** -
- **(ASR/ASA)** -

S2b GTPv2-C:

- TEID GTP
- GTP
- PGW

□□□□

□□□□

```

config/*.exe
IkeV2 □□□
VPN □□
Diameter

```

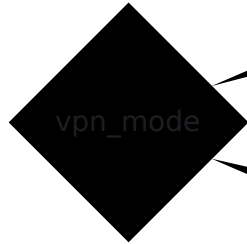

SWx + S6b + GTPv2-C

SWx + IP □ + TUN

□□□ config/runtime.exe □□□□□□□□□□□□□□□□ vpn_mode □□□ GTP □□□ VPN □□□□□□□□□□□□□□□□ □□□□□□

□□□□□□□ **GTP** □□□□

□□	IP □□	□□	□□
OmniEPDG (GTP-U)	10.74.0.11	-	GTP-U □□□□
OmniEPDG (Diameter S6b)	10.74.0.12	3868	S6b Diameter □□□
HSS	10.74.0.21	3868	SWx Diameter □□□
PGW	10.74.0.23	2123	GTPv2-C □ S6b □□□

VPN

Component	IP	Details
OmniEPDG (TUN)	10.44.0.1	tun_epdg IP
UE IP	10.45.0.0/16	CIDR IP
HSS	10.74.0.21:3868	SWx Diameter

3GPP

Reference	Protocol/Component	Details
TS 29.273	EPS AAA (SWx, S6b, SWm)	ePDG Diameter
TS 29.274	GTPv2-C & GTP-U	S2b GTP
TS 33.402	3GPP	WiFi & EAP-AKA
TS 23.402	3GPP	ePDG
TS 23.003		NAI & IMSI
TS 29.229	Cx/Dx Diameter	SWx
RFC 6733	Diameter	Diameter
RFC 4187	EAP-AKA	IKEv2









1. [Python 3 入門](#) 入門から実践まで
2. [Python 3 入門](#) 入門から実践まで
3. [Python 3 入門](#) 入門から実践まで GeolIP 編
4. [Python 3 入門](#) 入門から実践まで Prometheus 編
5. [Python 3 入門](#) 入門から実践まで









まとめ

1. [Python 3 入門](#) 入門から実践まで
2. [Python 3 入門](#) 入門から実践まで
3. [Python 3 入門](#) 入門から実践まで
4. [Python 3 入門](#) 3GPP 入門から実践まで

OmniEPDG

OmniEPDG  3GPP  ePDG WiFi 
WiFi  **GTP**  PGW  **VPN**  IP 

-  -  DNS 
-  - IKEv2 Diameter VPN 
-  - 

-  -  Diameter  Web 
-  - Prometheus 
-  - 

-  -  GeoIP 



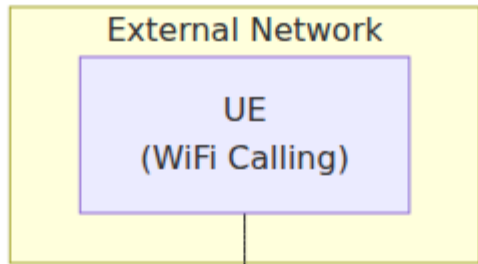

IKEv2

ore OmniCore OmniCall OmniRAN OmniCharge Platform 5GC

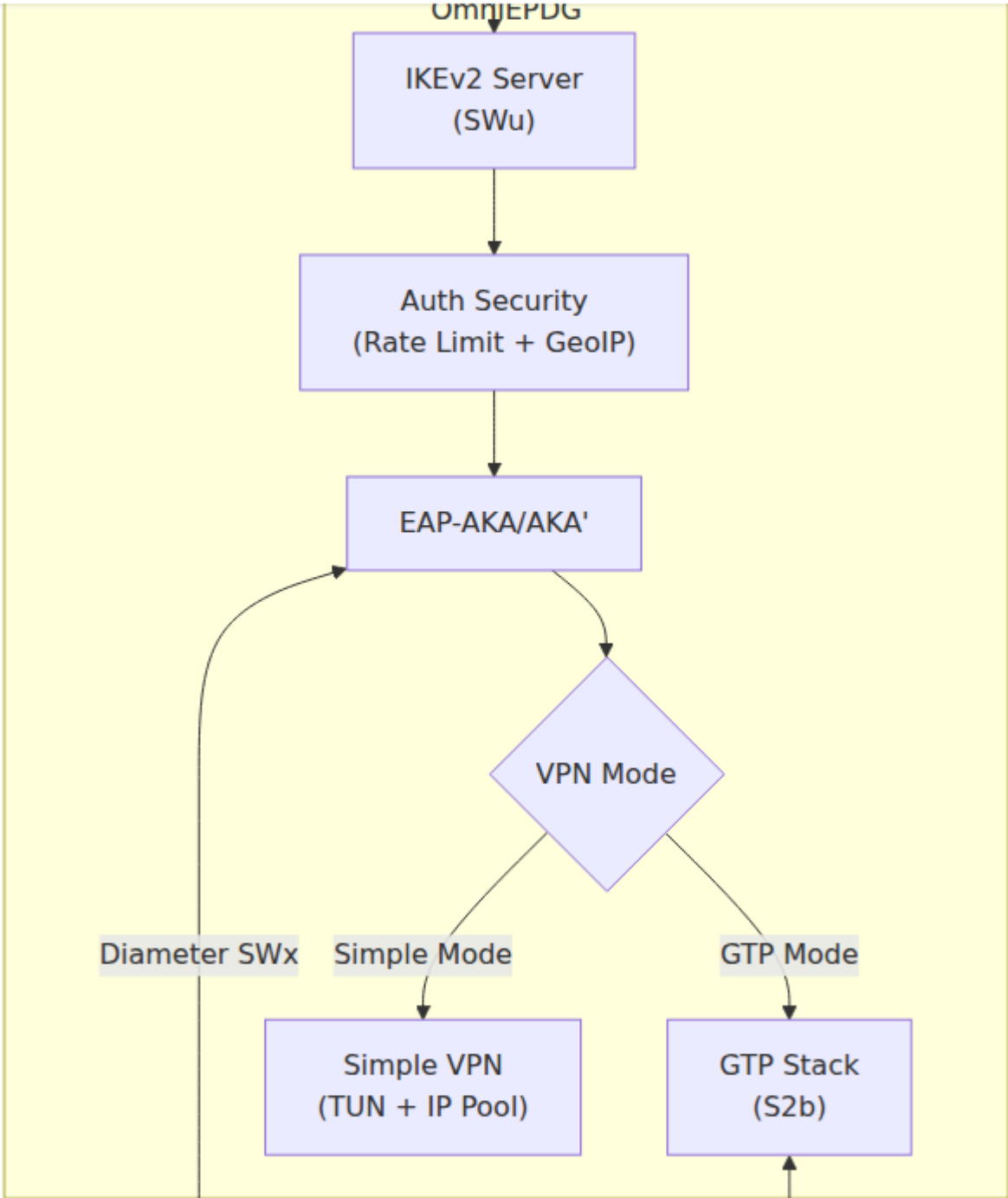

Diameter SWx

Simple Mode

GTP Mode

Diameter S6b

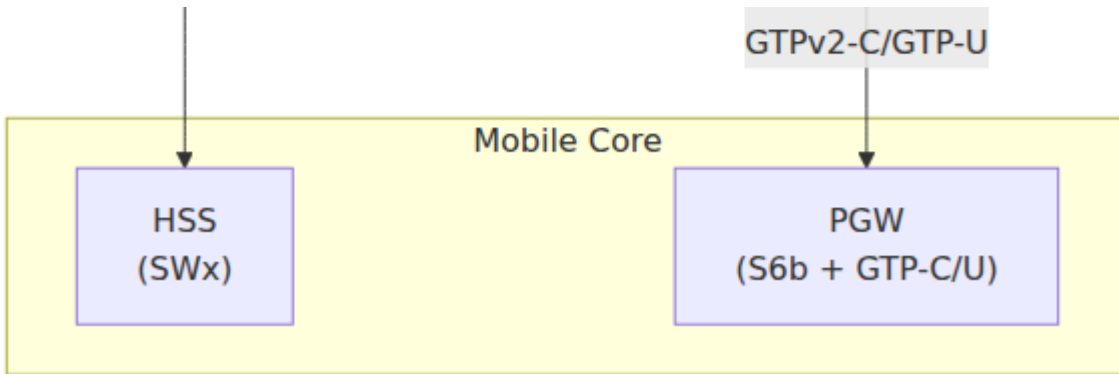

□□□□

OmniEPDG □□□□ `vpn_mode` □□□□□□□□□□□□□□

GTP □□

□□ PGW □□□□□ 3GPP □□□□□□□□□□ GTP-U □□□□□□□□□□

□□□□□

- □□□□□□□□□□□□□□
- □□ PCRF/PCEF □□□□□□□□
- □□□□□□□□□□□□

□□□□

- □□ PGW □□□□□ Diameter S6b
- □□□□□□□□□□/□□/□□□□□□□ GTPv2-C
- □□□□□□□□□□ Linux □□ GTP-U □□

□□ VPN □□

□□ TUN □□□□□□ IP □□□□□□□□□□□□□□ OmniEPDG □□□□□□□□ PGW □□□□

□□□□□

- □□ PGW □□□□□□
- □□□□□□
- □□□□□□□□

□□□□

□□□□□□□ **VPN** □□□

```
config :omniepdg,  
  vpn_mode: :simple,  
  simple_vpn: [  
    pool_ipv4: "10.45.0.0/16",  
    dns_servers_ipv4: ["8.8.8.8", "8.8.4.4"]  
  ]  
  
config :diameter_ex,  
  diameter: %{  
    host: "epdg",  
    realm: "epc.mnc001.mcc001.3gppnetwork.org",  
    peers: [  
      %{host: "hss", ip: "10.74.0.21", port: 3868, transport:  
:tcp}  
    ]  
  }  
}
```

□□□□□□□□

```
config :omniepdg,  
  # □□□□□□□□□□□□□□□□  
  auth_rate_limit_per_ip: 10,  
  auth_rate_limit_ip_block_ms: 300_000,  
  auth_rate_limit_per_imsi: 5,  
  auth_rate_limit_imsi_block_ms: 600_000,  
  
  # GeoIP □□□□□□□□  
  geoup_enabled: true,  
  geoup_mode: :whitelist,  
  geoup_countries: ["AU", "NZ"]
```

□□□□□□□□□□ □□□□□

□□

□□□□

□□ Web □□□□ `http://<host>:4000/dashboard` □□□□

- □□□□□□
- Diameter □□□□□
- □□□□□
- □□□□

□□□□□□□□□□ □□□□ □□□

Prometheus □□

□ `http://<host>:9568/metrics` □□□□□□□□

- □□□□□□/□□□□
- □□□□□□□□
- Diameter □□□□
- □□□□□□□□□□ GeolIP □□□
- IP □□□□
- ESP □□□□□□

□□□□□□□□□□□□ □□□□

□□□□

□□□□□□□□□□

項目	説明	備考
ネットワーク	ネットワーク SWx MAR/MAA	ネットワーク
Diameter 認証	認証サーバー	Diameter 認証
GTP 認証	ネットワーク GTPv2-C 認証	GTP 認証
VPN 接続	VPN TUN 接続	VPN 接続
IPsec	IPsec	IPsec
GeoIP 認証	GeoIP 認証	GeoIP 認証

ネットワーク 認証

ネットワーク

項目	説明
ネットワーク	ネットワーク
ネットワーク	ネットワーク
ネットワーク	ネットワーク Web 接続
ネットワーク	Prometheus 監視
ネットワーク	ネットワーク DNS 接続
ネットワーク	ネットワーク GeoIP 認証
ネットワーク	ネットワーク

OmniEPDG

OmniEPDG 3GPP ePDG, VoWiFi, GTP, PGW, VPN, TUN

Architecture

OmniEPDG Erlang/OTP, 3GPP ePDG, WiFi, VoWiFi

GTP

GTP PGW GTPv2-C Linux GTP-U

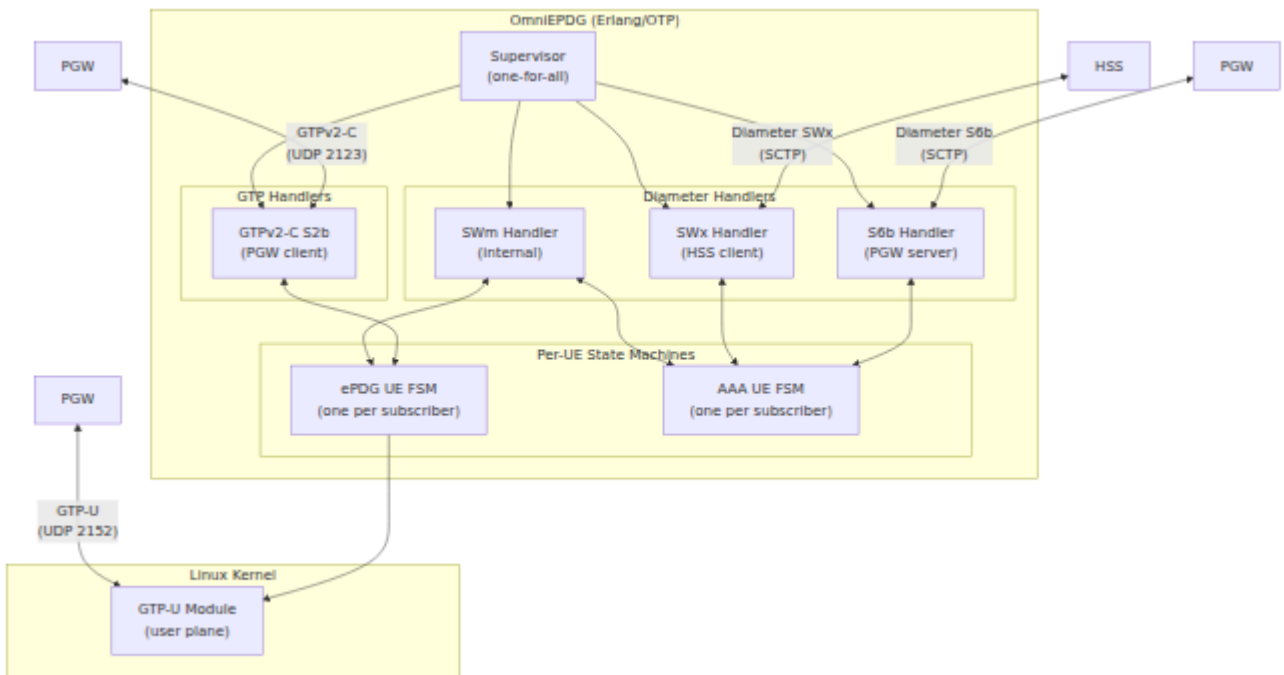

VPN

VPN Linux TUN PGW GTP Diameter S6b GTPv2-C GTP-U VPN

이름	기능	설명
aaa_diameter_swx	Diameter SWx 모듈	HSS와 연결되는 Diameter SWx 모듈
aaa_diameter_swm	Diameter SWm 모듈	ePDG, AAA FSM, Diameter EAP 모듈
epdg_diameter_swm	SWm ePDG 모듈	ePDG 모듈과 SWm Diameter 모듈

GTP 모듈

이름	기능	설명
aaa_diameter_s6b	Diameter S6b 모듈	PGW와 연결되는 Diameter S6b 모듈
epdg_gtpc_s2b	GTPv2-C 모듈	PGW와 연결되는 GTPv2-C 모듈
gtp_u_kmod	GTP-U 모듈	Linux에서 실행되는 GTP-U PDP 모듈

VPN 모듈

이름	기능	설명
simple_vpn_supervisor	VPN 모듈	VPN IP 주소 관리
simple_vpn_pool	IP 풀	ETS, CIDR, IPv4 풀
simple_vpn_route	루트	omniepdg@ TUN 모듈

참고

이 모듈은 IMSI 기반 OmniEPDG 모듈을 지원합니다.

- **ePDG UE FSM** (`epdg_ue_fsm`) - ePDG 프로세스에서 프로세스별 GTP 프로세스 관리
- **AAA UE FSM** (`aaa_ue_fsm`) - AAA 프로세스와 HSS 및 Diameter SWx 프로세스와 PGW 및 S6b 관리

이 FSM 프로세스는 Erlang `gen_statem` 프로세스를 기반으로 합니다.

ePDG UE FSM 프로세스

ePDG UE FSM 프로세스는 프로세스별 FSM 프로세스 `authenticated` 프로세스를 관리합니다.

GTP 프로세스 FSM

이 GTP 프로세스는 GTPv2-C 프로세스와 PGW 프로세스와 GTPv2-C 프로세스와 PGW 프로세스와 HSS 프로세스를 관리합니다.

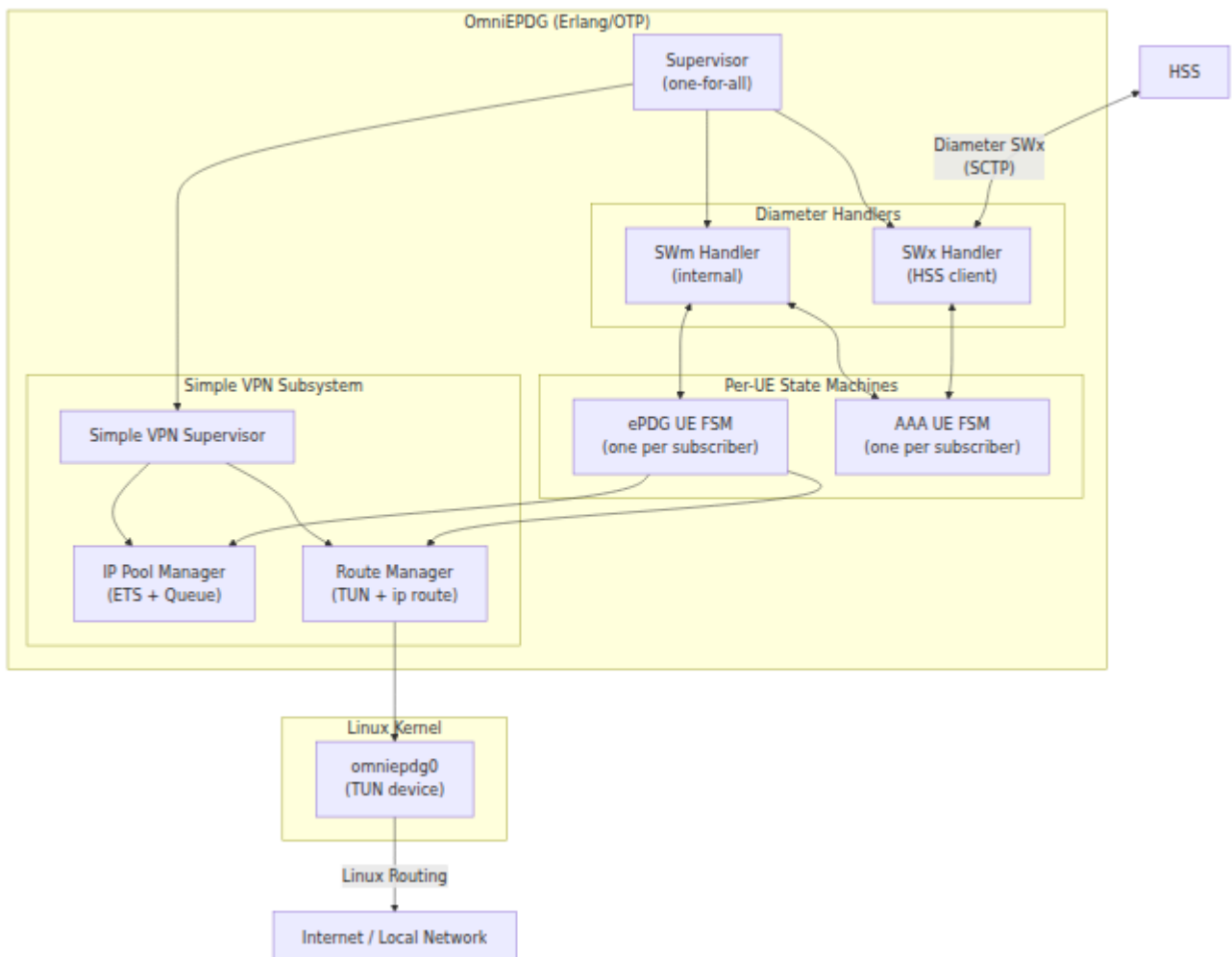

VPN FSM

VPN FSM authenticated FSM GTPv2-C IP TUN active GTP wait_create_session_resp wait_delete_session_resp dereg_pgw_wait_cancel dereg_net_wait_s2b_delete

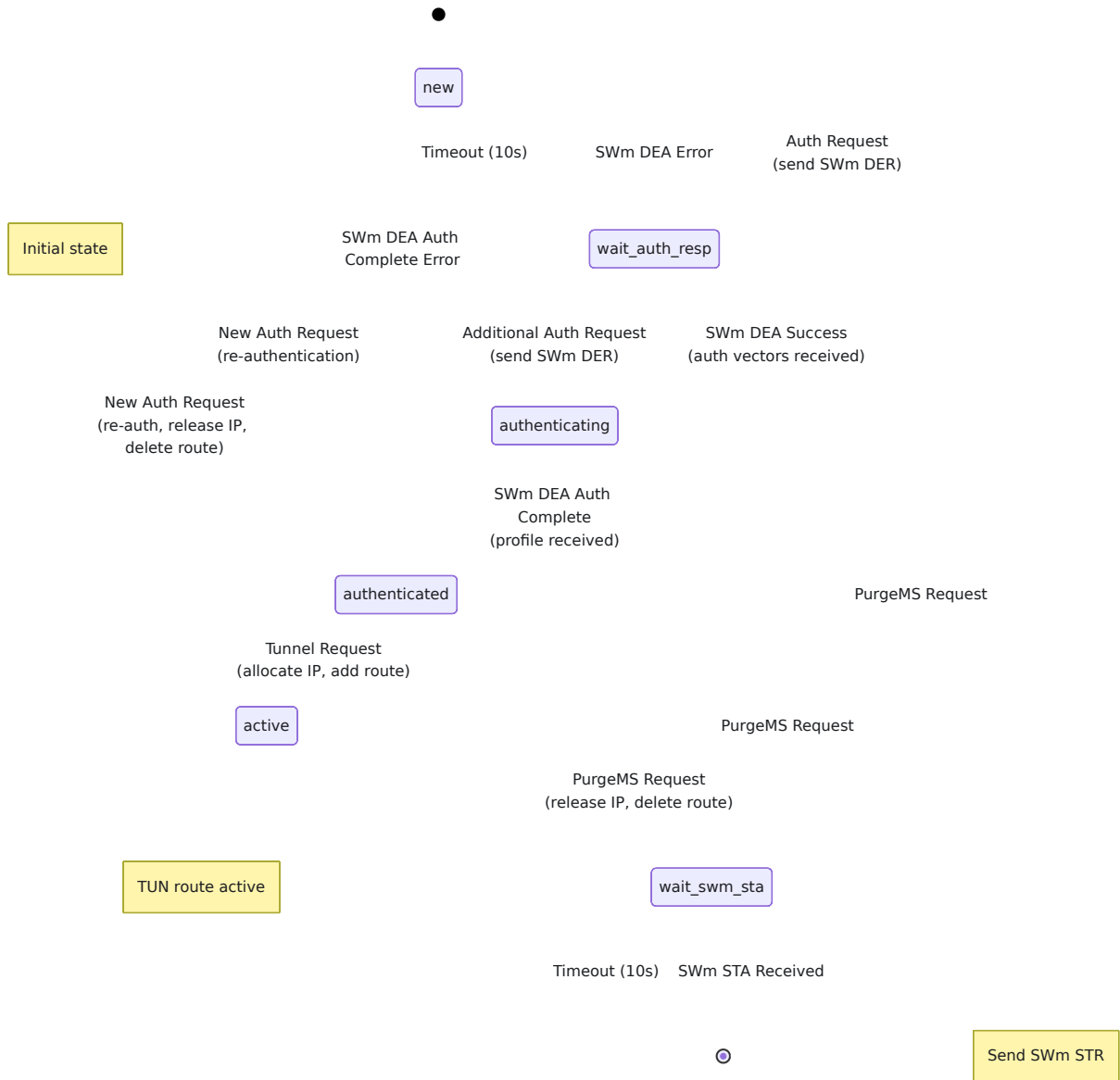

ePDG UE FSM

State	Event	Action	Result
new		Initial state	Initial state
wait_auth_resp		SWm DER received	SWm DEA received
authenticating		EAP exchange	EAP exchange
authenticated		Authentication successful	Authentication successful
wait_create_session_resp	GTP	PGW GTPv2-C create session request	PGW GTPv2-C create session response
active		Normal operation	Normal operation
wait_delete_session_resp	GTP	PGW GTPv2-C delete session request	PGW GTPv2-C delete session response
wait_swm_sta		SWm STA received	AAA SWm STA received
dereg_pgw_wait_cancel	GTP	PGW deregistration request	PGW deregistration response
dereg_net_wait_cancel	GTP	HSS deregistration request	HSS deregistration response
dereg_net_wait_s2b_delete	GTP	PGW S2b delete request	PGW S2b delete response

AAA UE FSM

AAA UE FSM HSS SWx PGW S6b Diameter

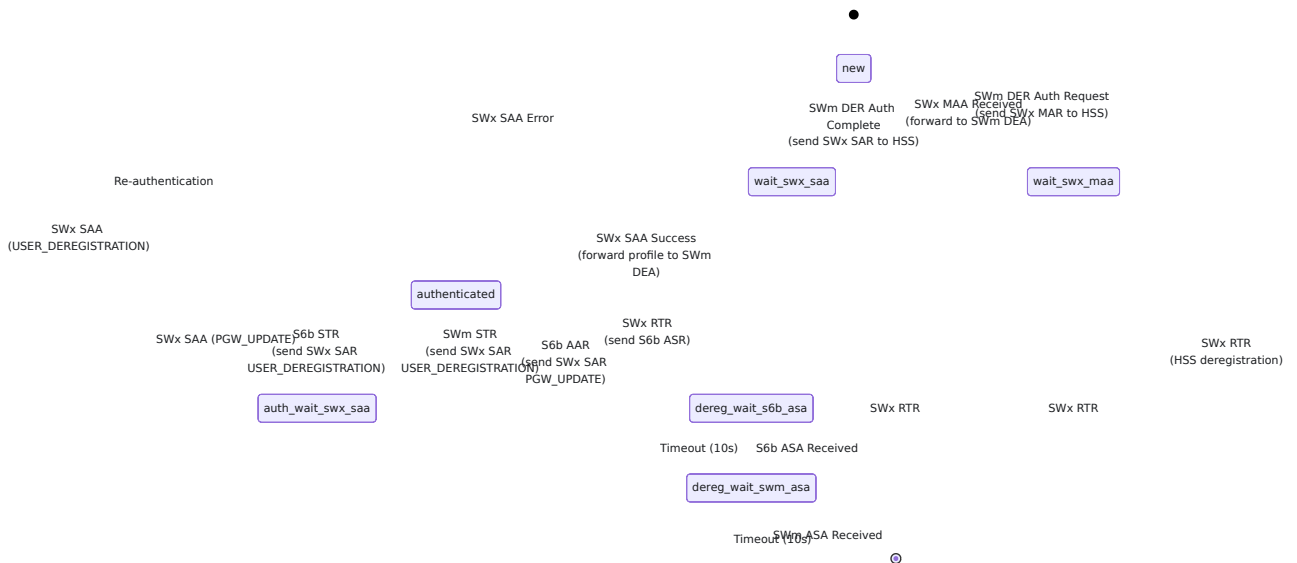

AAA UE FSM

状態	動作	接続先
new	AAA へ接続	Diameter
wait_swx_maa	SWx MAR から HSS へ EAP-AKA を送信	HSS から SWx MAA
wait_swx_saa	SWx SAR から HSS へ接続	HSS から SWx SAA
authenticated	ePDG を PGW へ接続	
auth_wait_swx_saa	PGW から SWx SAR へ接続	HSS から SWx SAA
dereg_net_wait_s6b_asa	HSS から PGW へ S6b ASR を送信	PGW から S6b ASA
dereg_net_wait_swm_asa	S6b から SWm ASR へ ePDG を送信	ePDG から SWm ASA

接続先

GTP

EAP-AKA を送信する GTP

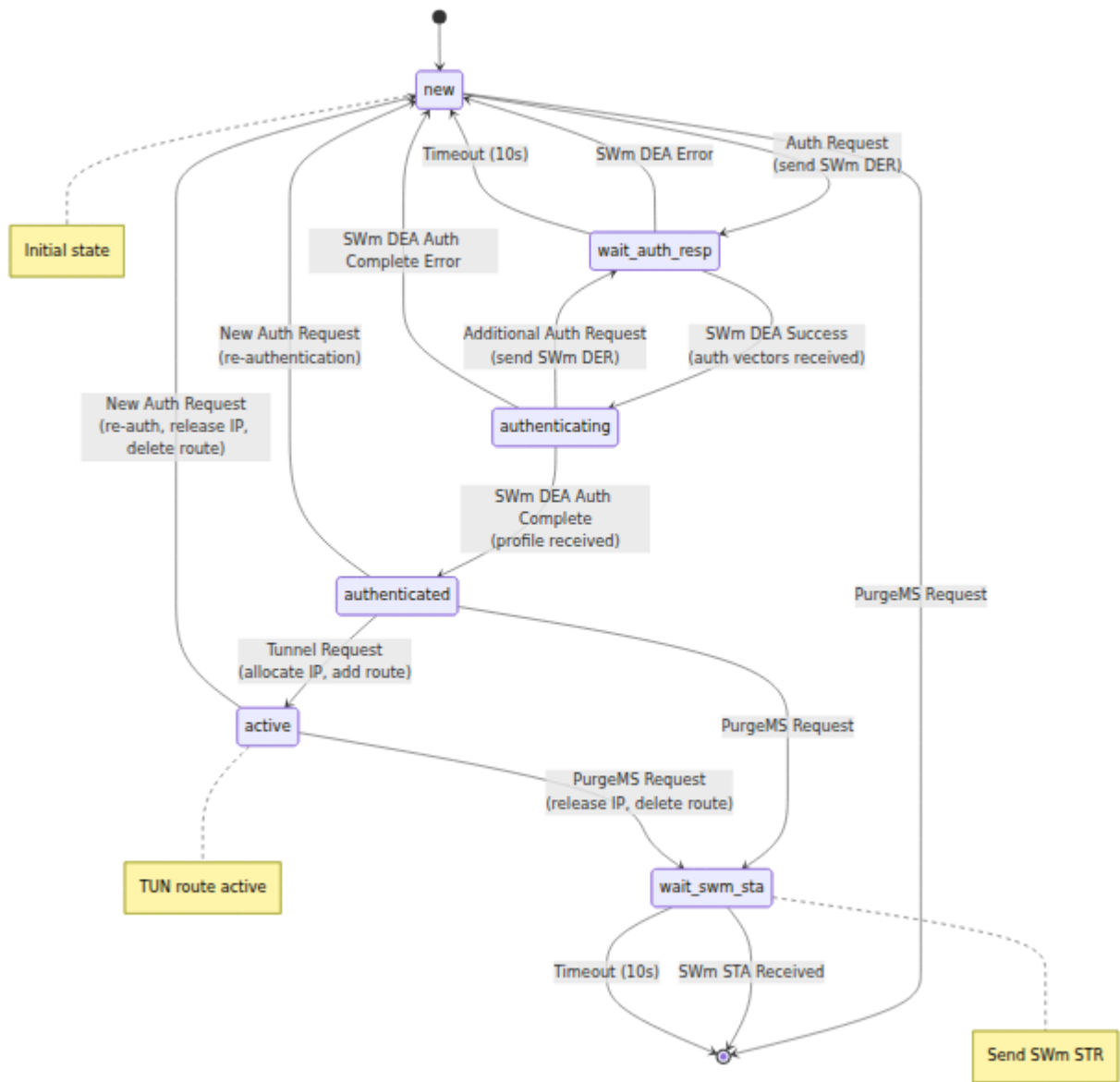

GTP 认证鉴权流程

认证鉴权流程 WiFi 认证鉴权流程

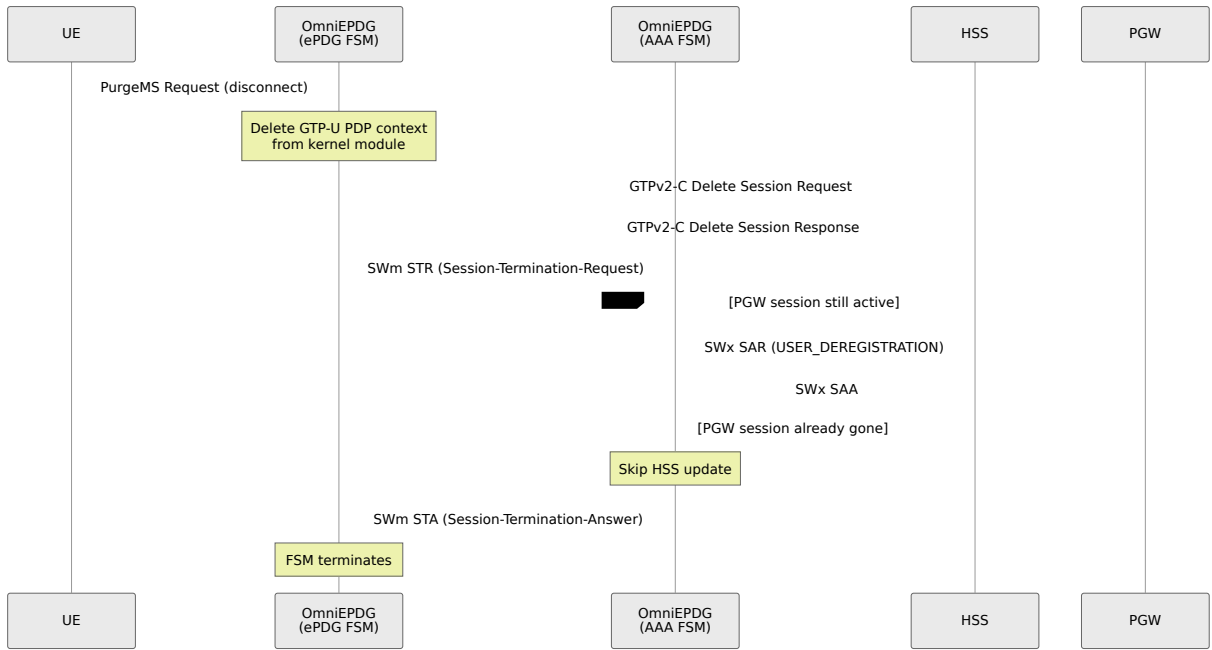

GTP PGW

PGW

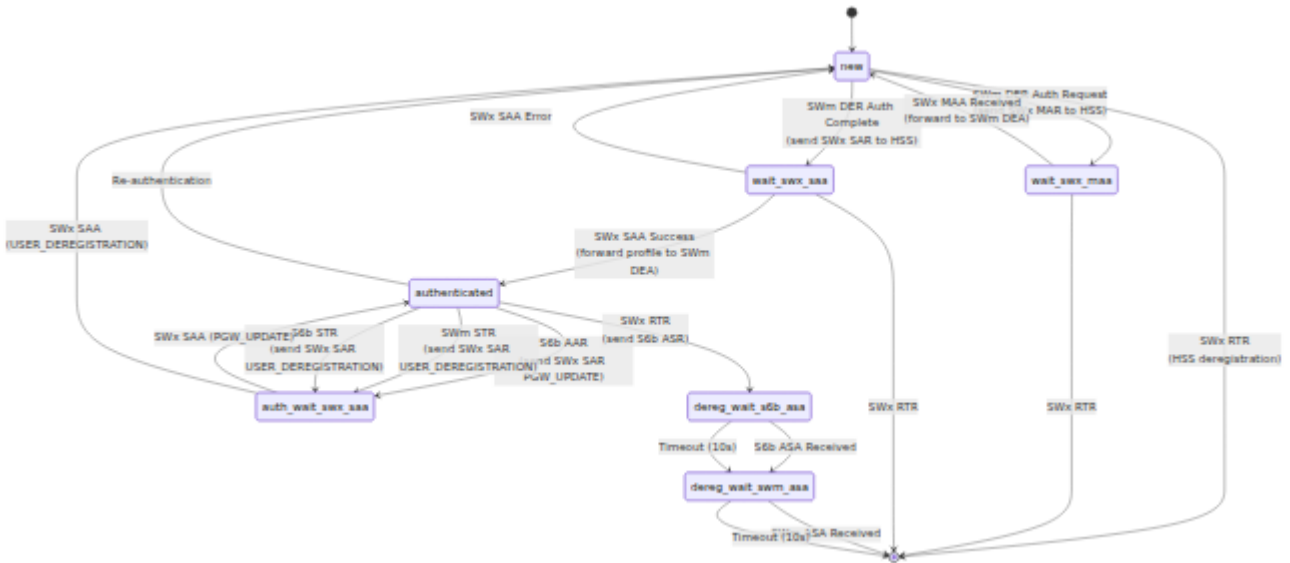

GTP HSS

HSS

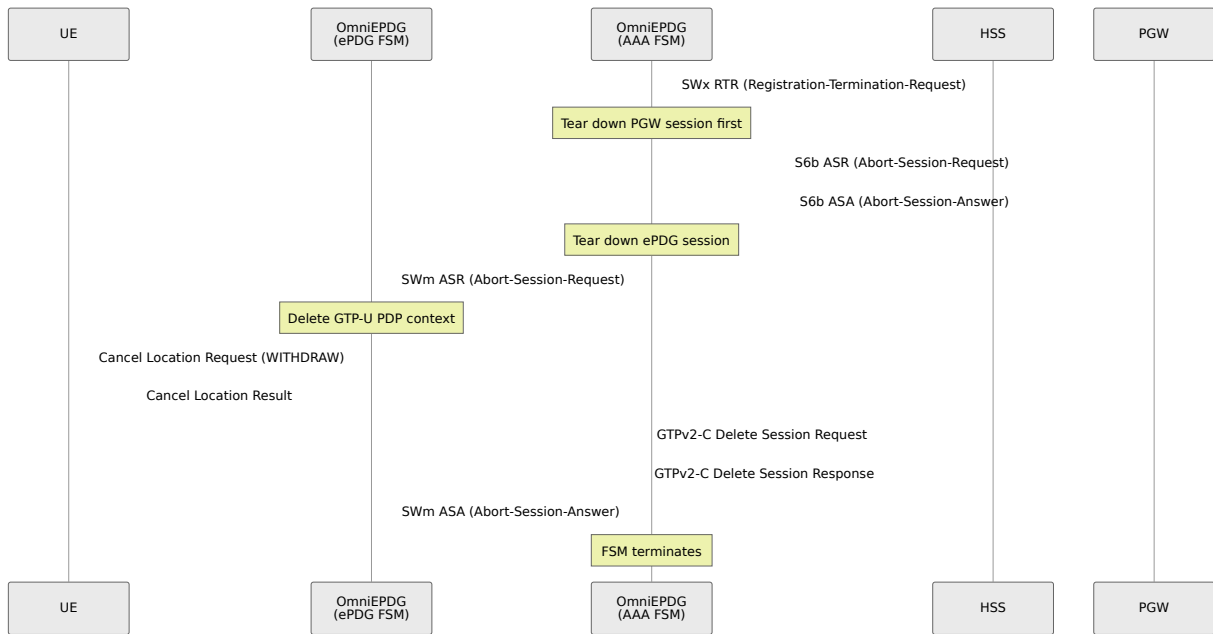

GTP HSS

HSS OmniEPDG 3GPP TS 29.273 8.1.2.3.3 ePDG
 SWm PGW S6b

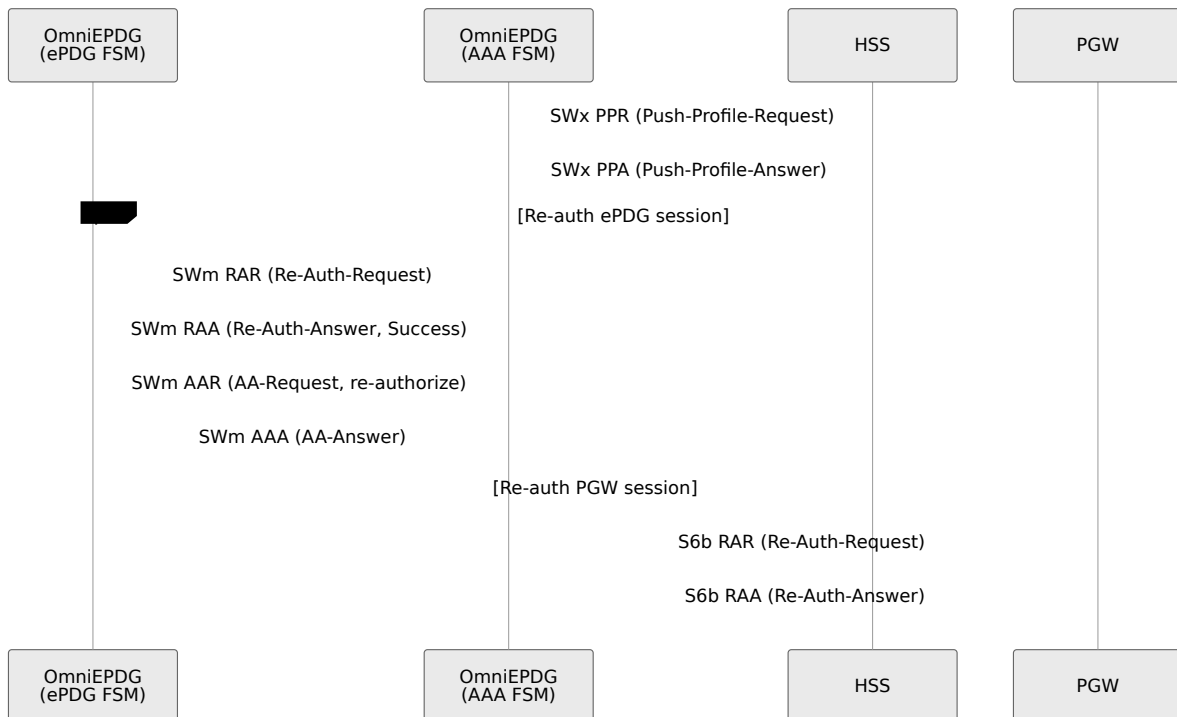

VPN EAP-AKA

VPN EAP-AKA ePDG FSM IP TUN PGW skip_sar HSS SAR/SAA

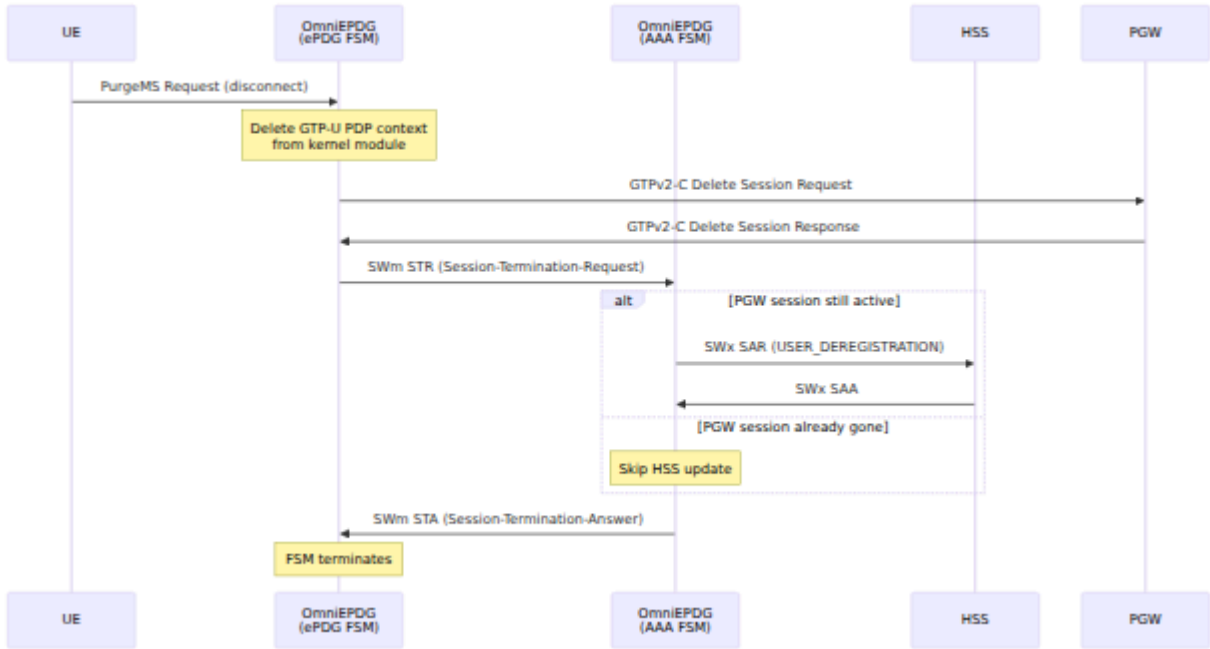

VPN FSM IP

VPN FSM IP

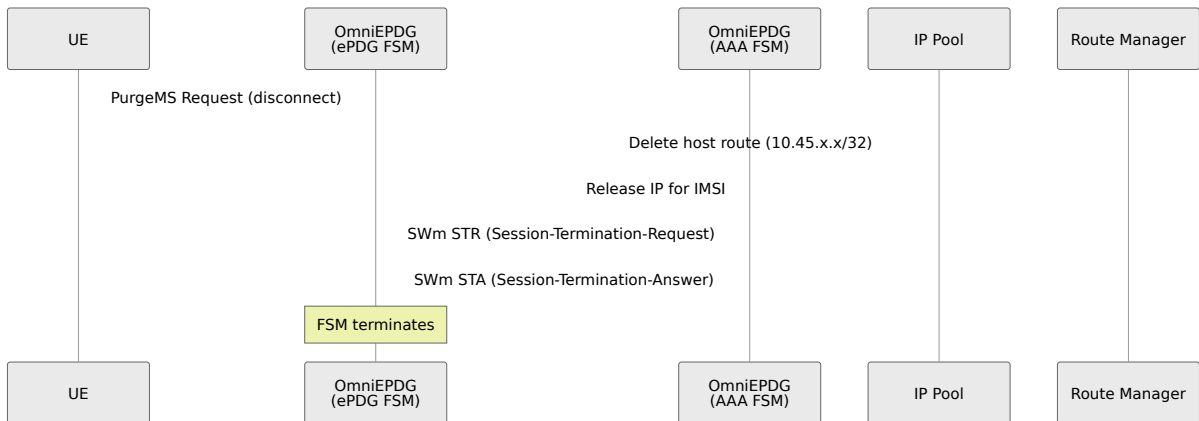

3GPP 错误码列表

错误码	描述	来源	版本
4181	DIAMETER_AUTHENTICATION_DATA_UNAVAILABLE	HSS 数据不可用	3GPP TS 29.273
5001	DIAMETER_ERROR_USER_UNKNOWN	未知 IMSI 用户 HSS 数据不可用	3GPP TS 29.273
5002	DIAMETER_UNKNOWN_SESSION_ID	未知会话 ID STR/AAR	RFC 673
5003	DIAMETER_AUTHORIZATION_REJECTED	授权被拒绝	3GPP TS 29.273
5004	DIAMETER_ERROR_ROAMING_NOT_ALLOWED	漫游不被允许	3GPP TS 29.273
5005	DIAMETER_MISSING_AVP	缺少 AVP	RFC 673
5012	DIAMETER_UNABLE_TO_COMPLY	无法遵守	RFC 673
5420	DIAMETER_ERROR_UNKNOWN_EPS_SUBSCRIPTION	未知 EPS 订阅	3GPP TS 29.273
5421	DIAMETER_ERROR_RAT_NOT_ALLOWED	RAT 不被允许	3GPP TS 29.273

코드	이름	설명	참고
5422	DIAMETER_ERROR_EQUIPMENT_UNKNOWN	IMEI 값이 없음	3GPP TS 29.274

GTPv2-C 메시지 목록 GTP 메시지

OmniEPDG 및 PGW-CP/CP-Only에서 GTPv2-C 메시지 번호 1-15는 3GPP TS 29.274 8.4.1에서 정의되며, 메시지 번호 16-63는 3GPP TS 29.274 8.4.2에서 정의됩니다.

메시지

번호	이름	설명
16	Request Accepted	요청이 성공적으로 처리되었습니다.
17	Request Accepted Partially	요청이 부분적으로 성공적으로 처리되었습니다.
18	New PDN Type (Network Preference)	네트워크 선호도에 따라 새로운 PDN 유형을 제공합니다.
19	New PDN Type (Single Address Bearer)	단일 주소 베어러를 사용하여 새로운 PDN 유형을 제공합니다.

エラーメッセージ

エラーコード	エラーメッセージ	原因
64	Context Not Found	PGW コンテキストが見つからない
73	No Resources Available	PGW リソース不足
78	Missing or Unknown APN	APN が PGW に登録されていない
82	Denied in RAT	ネットワークアクセスが拒否された
84	All Dynamic Addresses Occupied	PGW の動的 IP アドレスがすべて占有されている
92	User Authentication Failed	PGW ユーザー認証が失敗した
93	APN Access Denied	APN にアクセスが拒否された
96	IMSI/IMEI Not Known	IMSI/IMEI が不明である
109	Invalid Peer	不正なピアである
113	APN Congestion	APN が混雑している
120	GTP-C Entity Congestion	PGW GTP-C エンティティが混雑している

NAI

OmniEPDG は 3GPP TS 23.003 の 19.1.2.2.1 に定義されている NAI の形式に従う。

```
<prefix><IMSI>@nai.epc.mnc<MNC>.mcc<MCC>.3gppnetwork.org
```

NAI の構成

NAI の形式は 3GPP TS 23.003 の 19.1.2.2.1 に定義されている EAP の形式に従う。

Priority	Protocol	Authentication Method
0	EAP-AKA	AKA over WiFi
6	EAP-AKA'	AKA over IPsec

OmniEPDG [EAP-AKA](#) WiFi

OmniEPDG @ IMSI IMSI

IPsec

OmniEPDG [3GPP TS 33.402](#) [RFC 7296](#) IKEv2

IKEv2

Algorithm	ID	Key Length	Support	Reference
AES-CBC	12	128, 192, 256 bits	Supported (default: 256)	RFC 3602
AES-GCM-16	20	128, 192, 256 bits	Supported	RFC 5282
AES-GCM-12	19	128, 192, 256 bits	Supported	RFC 5282
AES-GCM-8	18	128, 192, 256 bits	Supported	RFC 5282
3DES	3	192 bits	Supported (legacy)	RFC 2451

IKEv2 □□□□□

□□	ID	□□□□	ICV □□	□□	□□
HMAC-SHA2-256-128	12	256 bits	128 bits	Supported (default)	RFC 4868
HMAC-SHA2-384-192	13	384 bits	192 bits	Supported	RFC 4868
HMAC-SHA2-512-256	14	512 bits	256 bits	Supported	RFC 4868
HMAC-SHA1-96	2	160 bits	96 bits	Supported (legacy)	RFC 2404
HMAC-MD5-96	1	128 bits	96 bits	Supported (legacy)	RFC 2403

IKEv2 PRF □□

□□	ID	□□□□	□□	□□
PRF-HMAC-SHA2-256	5	256 bits	Supported (default)	RFC 4868
PRF-HMAC-SHA2-384	6	384 bits	Supported	RFC 4868
PRF-HMAC-SHA2-512	7	512 bits	Supported	RFC 4868
PRF-HMAC-SHA1	2	160 bits	Supported (legacy)	RFC 2104
PRF-HMAC-MD5	1	128 bits	Supported (legacy)	RFC 2104

IKEv2 Diffie-Hellman

	ID			
MODP-2048	14	2048 bits	Supported (default)	RFC 3526
MODP-1024	2	1024 bits	Supported (legacy)	RFC 2409
MODP-1536	5	1536 bits	Supported	RFC 3526
MODP-3072	15	3072 bits	Supported	RFC 3526
MODP-4096	16	4096 bits	Supported	RFC 3526
ECP-256	19	256 bits	Supported	RFC 5903
ECP-384	20	384 bits	Supported	RFC 5903
ECP-521	21	521 bits	Supported	RFC 5903
Curve25519	31	256 bits	Supported	RFC 8031
Curve448	32	448 bits	Supported	RFC 8031

ESP SA

ESP IKEv2 CREATE_CHILD_SA

ESP

- AES-CBC-256 32 16 IV
- HMAC-SHA2-256-128 32 16 ICV

EAP-AKA □□□□

□□	□□	□□
MK □□	SHA-1	RFC 4187 □ 7 □
PRF+ □□□□	FIPS 186-2 PRF□SHA-1□	RFC 4187 □□ D
AT_MAC	HMAC-SHA1-128	RFC 4187 □ 10.15 □
Milenage□f1-f5□	AES-128	3GPP TS 35.206

EAP-AKA' □□□□

□□	□□	□□
CK'/IK' □□	HMAC-SHA-256	RFC 5448 □ 3.3 □
MK □□	SHA-256	RFC 5448 □ 3.4 □
AT_MAC	HMAC-SHA256-128	RFC 5448 □ 3.1 □

3GPP □□□

OmniEPDG □□□ 3GPP TS 33.402 □ 8 □□□□□□□□□□□□□□

項目	仕様	対応状況
IKEv2 暗号化	AES-CBC-128	✓ 対応
IKEv2 認証	HMAC-SHA2-256-128	✓ 対応
IKEv2 PRF	PRF-HMAC-SHA-256	✓ 対応
IKEv2 DH	14 MODP-2048	✓ 対応
ESP 暗号化	AES-CBC-128/256	✓ 対応
ESP 認証	HMAC-SHA2-256-128	✓ 対応
EAP-AKA	RFC 4187	✓ 対応
EAP-AKA'	RFC 5448	✓ 対応

PDP 設定 GTP 設定

OmniEPDG 3GPP TS 29.274 8.14 PDP 設定 VPN 設定 IPv4 設定

項目	仕様	GTPv2-C PAA 設定
IPv4	IPv4	4 IPv4
IPv6	IPv6	1 + 16 IPv6
IPv4v6	IPv4v6	1 + 16 IPv6 + 4 IPv4

OmniEPDG 部署

OmniEPDG 通过 `config/runtime.exe` 部署 - 部署

部署

部署

- IKEv2 部署
- 部署
- VPN 部署
- VPN 部署
- Diameter 部署
- 部署
- 部署
- Prometheus 部署
- 部署
- 部署

□□□□

```
# config/runtime.exs
config :omniepdg,
  # IKEv2 □□□□
  listen_ip: {0, 0, 0, 0},
  port_500: 500,
  port_4500: 4500,

  # VPN □□: :simple (□□□□) □ :gtp (□□ GTP-C □ PGW)
  vpn_mode: :simple,

  # □□ VPN □□□□
  simple_vpn: [
    pool_ipv4: "10.45.0.0/16",
    pool_ipv6: "2001:db8::/32",
    dns_servers_ipv4: ["8.8.8.8", "8.8.4.4"],
    dns_servers_ipv6: ["2001:4860:4860::8888",
"2001:4860:4860::8844"]
  ]

# □□□□□□
config :control_panel,
  parent_application: :omniepdg,
  parent_application_readable_name: "OmniEPDG",
  use_additional_pages: [
    {OmniEpdg.Web.DashboardLive, "/", "Dashboard"},
    {OmniEpdg.Web.SessionsLive, "/sessions", "Sessions"},
    {OmniEpdg.Web.DiameterLive, "/diameter", "Diameter"}
  ]

# Diameter □□ (runtime.exs)
config :diameter_ex,
  diameter: %{
    service_name: :omniepdg,
    listen_ip: "0.0.0.0",
    listen_port: 3868,
    host: "epdg",
    realm: "epc.mnc001.mcc001.3gppnetwork.org",
    product_name: "OmniEPDG",
    vendor_id: 10415,
    applications: [
      %{application_name: :swx, application_id: 16_777_265,
```

```
vendor_id: 10415},
  %{application_name: :s6b, application_id: 16_777_272,
vendor_id: 10415}
],
peers: [
  %{host: "hss", ip: "127.0.0.1", port: 3868, transport: :tcp}
]
}

# 许可证客户端 (runtime.exs)
config :license_client,
  server_url: "https://license.example.com/api",
  product: "omniepdg"
```

IKEv2 配置

IKEv2 配置 UEs 与 OmniEPDG 交互 SWu 配置 IPsec 配置 EAP-AKA 配置

변수명	타입	타입	값
listen_ip	문자열	문자열	{0, 0, 0, 0}
port_500	정수	정수	500
port_4500	정수	정수	4500
cert_file	문자열	문자열	/etc/omniepdg/certs/epdg.crt

項目	種別	単位	値
key_file	文字列		/etc/omniepdg/certs/epdg.key
session_inactivity_timeout_ms	整数	ms	300000

設定例

OmniEPDG の設定例を示します。

設定例

```

config :omniepdg,
  # IP 制限
  auth_rate_limit_per_ip: 10,
  auth_rate_limit_ip_window_ms: 60_000,
  auth_rate_limit_ip_block_ms: 300_000,

  # IMSI 制限
  auth_rate_limit_per_imsi: 5,
  auth_rate_limit_imsi_window_ms: 60_000,
  auth_rate_limit_imsi_block_ms: 600_000

```

項目	単位	範囲	初期値	説明
auth_rate_limit_per_ip	回	回	10	IPアドレスごとに認証回数を制限する
auth_rate_limit_ip_window_ms	ms		60000	IPアドレスごとに制限する期間
auth_rate_limit_ip_block_ms	ms		300000	IPアドレスごとに制限を超過した場合のブロック期間
auth_rate_limit_per_imsi	回	回	5	IMSIごとに認証回数を制限する
auth_rate_limit_imsi_window_ms	ms		60000	IMSIごとに制限する期間
auth_rate_limit_imsi_block_ms	ms		600000	IMSIごとに制限を超過した場合のブロック期間

GeoIP

```

config :omniepdg,
  geoup_enabled: false,
  geoup_database_path: "/etc/omniepdg/GeoLite2-Country.mmdb",
  geoup_mode: :whitelist,
  geoup_countries: ["AU", "NZ"],
  geoup_allow_unknown: false,
  geoup_fail_open: true

```

項目	型別	デフォルト値	説明
<code>geoup_enabled</code>	ブール値	<code>false</code>	GeoIP MaxMind GeoLite2 を有効にするかどうか
<code>geoup_database_path</code>	文字列	<code>"/etc/omniepdg/GeoLite2-Country.mmdb"</code>	MaxMind GeoLite2 データベースの MMDB ファイルのパス
<code>geoup_mode</code>	文字列	<code>:whitelist</code>	<code>:whitelist</code> モード <code>:blacklist</code> モード
<code>geoup_countries</code>	文字列	<code>[]</code>	ISO 3166-1 alpha-2 コード <code>["AU", "NZ", "US"]</code>
<code>geoup_allow_unknown</code>	ブール値	未知	未知のIP に対して <code>false</code> または <code>true</code>
<code>geoup_fail_open</code>	ブール値	<code>true</code>	GeoIP エラー 発生時の 動作

VPN 配置

名称	类型	模式	配置	备注
vpn_mode	简单	简单	EPDG_VPN_MODE	配置为 simple 模式，TUN 隧道 IP 地址为 gtp 模式，GTPv2-C/GTP-U 协议，PGW 接口配置。

VPN 配置

simple_vpn 配置为 VPN 模式，IP 地址池，DNS 服务器，OmniEPDG 模式，IPv4 和 IPv6 地址池。

```

config :omniepdg,
  simple_vpn: [
    pool_ipv4: "10.45.0.0/16",
    pool_ipv6: "2001:db8::/32",
    dns_servers_ipv4: ["8.8.8.8", "8.8.4.4"],
    dns_servers_ipv6: ["2001:4860:4860::8888",
"2001:4860:4860::8844"],
    p_cscf_ipv4: ["10.4.12.165"],
    p_cscf_ipv6: [],
    mtu: 1400,
    nat_enabled: true
  ]

```

名称	类型	范围	描述
pool_ipv4	IP池	IPv4	CIDR 10.45.0.0/16 IPv4 地址池 用于 IPv4
pool_ipv6	IP池	IPv6	CIDR 2001:db8::/32 IPv6 地址池 用于 IPv6
dns_servers_ipv4	服务器	IPv4	PCO 配置 用于 IPv4 DNS 服务器
dns_servers_ipv6	服务器	IPv6	PCO 配置 用于 IPv6 DNS 服务器
p_cscf_ipv4	服务器	IPv4	VoWiFi 配置 IPv4 P-CSCF/IMS 服务器
p_cscf_ipv6	服务器	IPv6	VoWiFi 配置 IPv6 P-CSCF/IMS 服务器
mtu	MTU		MTU 值 1400

項目	項目	項目	項目	項目
nat_enabled			true	項目 NAT項目 true 項目 項目

Diameter 項目

Diameter 項目 SWx項目HSS項目 S6b項目PGW項目項目 diameter_enabled 項目 true 項目
 OmniEPDG 項目 Diameter 項目項目項目項目項目項目

```

config:diameter_ex,
  diameter: %{
    service_name: :omniepdg,
    listen_ip: "0.0.0.0",
    listen_port: 3868,
    host: "epdg",
    realm: "epc.mnc001.mcc001.3gppnetwork.org",
    product_name: "OmniEPDG",
    vendor_id: 10415,
    applications: [
      %{application_name: :swx, application_id: 16_777_265,
        vendor_id: 10415},
      %{application_name: :s6b, application_id: 16_777_272,
        vendor_id: 10415}
    ],
    peers: [
      %{host: "hss", ip: "10.74.0.21", port: 3868, transport:
:tcp}
    ]
  }

```

項目

項目	種別	単位	値	注
service_name	文字列		:omniepdg	-
listen_ip	文字列		"0.0.0.0"	DIA_LISTEN_IP
listen_port	整数		3868	DIA_LISTEN_PORT
host	文字列		"epdg"	DIA_HOSTNAME
realm	文字列		"epc.mnc001.mcc001.3gppnetwork.org"	DIA_REALM

Field	Value	Unit	Description	Default
product_name	"OmniEPDG"			-
vendor_id	10415			-

Peers

peers Diameter HSS

Field	Value	Unit	Default	Parameter	Description
host			-	HSS_HOST	Diameter Origin-Host
ip			-	HSS_IP	IP TCP/SCTP
port			3868	HSS_PORT	Diameter
transport			:tcp	-	:tcp :sctp

ID

名前	ID	グループ ID	接続	規格
SWx	16777265	10415	ePDG ↔ HSS	3GPP TS 29.273
S6b	16777272	10415	AAA ↔ PGW	3GPP TS 29.273

ライセンスクライアント

ライセンスクライアント OmniEPDG の設定

```
config :license_client,
  server_url: "https://license.example.com/api",
  product: "omniepdg"
```

名前	タイプ	値	説明
server_url	文字列	-	LICENSE_SERVER_URL API の URL
product	文字列	"omniepdg"	ライセンス製品名

Web コンソール

Web コンソールの設定

```
config :control_panel,
  port: 4000
```

Port	Protocol	Service	Port	Environment Variable	Description
port	HTTP	CONTROL_PANEL	4000	CONTROL_PANEL_PORT	Web UI HTTP

Prometheus

OmniEPDG HTTP Prometheus

```
config :omniepdg,
  prometheus: %{
    port: 9568
  }
```

Port	Protocol	Service	Port	Environment Variable	Description
port	HTTP	Prometheus	9568	PROMETHEUS_PORT	/metrics HTTP

Metrics

Available Metrics

- epdg_ikev2_session_initiated_count - IKE_SA_INIT
- epdg_ikev2_session_established_count - IKE SA
- epdg_ikev2_session_failed_count - IKE SA
- epdg_eap_identity_count - EAP
- epdg_eap_aka_challenge_count - EAP-AKA
- epdg_eap_aka_success_count - EAP-AKA
- epdg_eap_aka_failure_count - EAP-AKA
- epdg_eap_aka_sync_failure_count - EAP-AKA SQN
- epdg_diameter_swx_mar_count - Diameter
- epdg_diameter_swx_sar_count - Diameter
- epdg_diameter_s6b_aar_count - Diameter AA

- `epdg_diameter_s6b_str_count` - 字符串
- `epdg_session_created_count` - 创建会话数 `vpn_mode`
- `epdg_session_terminated_count` - 终止会话数
- `epdg_esp_packets_in_count` - ESP 包入
- `epdg_esp_packets_out_count` - ESP 包出
- `epdg_ip_allocated_count` - IP 地址分配数
- `epdg_ip_released_count` - IP 地址释放数

计数器 5

- `epdg_sessions_active_count` - 活跃会话数
- `epdg_sessions_by_state_count` - FSM 状态数
- `epdg_ip_pool_allocated_count` - IP 池分配数
- `epdg_ip_pool_available_count` - IP 池可用数
- `epdg_ip_pool_utilization_ratio` - IP 池利用率 0.0-1.0
- `epdg_diameter_swx_pending_count` - SWx 待处理数
- `epdg_diameter_s6b_active_sessions_count` - S6b 活跃会话数

性能计数器

- `epdg_auth_duration_ms` - 认证耗时
- `epdg_diameter_swx_mar_latency_ms` - MAR 延迟
- `epdg_diameter_swx_sar_latency_ms` - SAR 延迟
- `epdg_session_duration_seconds` - 会话持续时间

VM 性能

- `vm_memory_total` - VM 总内存
- `vm_memory_processes` - VM 进程数
- `vm_memory_binary` - VM 二进制文件数
- `vm_memory_ets` - ETS 内存数
- `vm_system_info_process_count` - 系统信息进程数
- `vm_system_info_port_count` - 系统信息端口数
- `vm_statistics_run_queue` - 运行队列数

Prometheus 配置

```

scrape_configs:
  - job_name: 'omniepdg'
    static_configs:
      - targets: ['localhost:9568']

```

Table

Table FSM configuration table

Protocol	Interval	Protocol	FSM	Target
GTP	10,000 ms	GTP	ePDG UE FSM	PGW GTPv2-C
SWm	10,000 ms		ePDG UE FSM	Diameter SWm
S6b	10,000 ms	GTP	AAA UE FSM	Diameter S6b

File

File `config/runtime.exe` configuration

IKEv2 配置

項目	値	説明
EPDG_LISTEN_IP	"0.0.0.0"	IKEv2 接続を 受け付ける IP "10.0.0.1"
EPDG_PORT_500	"500"	IKE 接続ポート
EPDG_PORT_4500	"4500"	IKE NAT- Traversal ポート
EPDG_CERT_FILE	"/etc/omniepdg/certs/epdg.crt"	IKEv2 接続に 使用する PEM形式の 証明書
EPDG_KEY_FILE	"/etc/omniepdg/certs/epdg.key"	IKEv2 接続に 使用する PEM形式の 秘密鍵
EPDG_SESSION_TIMEOUT	"300000"	セッション タイムアウト 時間

VPN 設定

項目	値	説明
EPDG_VPN_MODE	"simple"	VPN モード "simple" または "gtp"

Diameter

변수	값	설명
DIA_LISTEN_IP	"0.0.0.0"	Diameter 서버 수신 IP 주소
DIA_LISTEN_PORT	"3868"	Diameter 서버 수신 포트
DIA_HOST	"epdg"	Diameter Origin-Host 이름
DIA_REALM	"epc.mnc001.mcc001.3gppnetwork.org"	Diameter Origin-Realm 이름

HSS 구성

변수	값	설명
HSS_HOST	"hss"	HSS Diameter 서버 Origin-Host 이름
HSS_IP	"127.0.0.1"	HSS IP 주소
HSS_PORT	"3868"	HSS Diameter 서버 포트

□□□□□□□□□□

□□	□□	□□
LICENSE_SERVER_URL	-	□□□□□□ API URL□□□□□
CONTROL_PANEL_PORT	"4000"	□□□□ HTTP □□□
PROMETHEUS_PORT	"9568"	Prometheus □□ HTTP □□□ /metrics □□□□

📄📄📄 Docker Compose

```
services:
  omniepdg:
    image: omniepdg:latest
    environment:
      # IKEv2
      EPDG_LISTEN_IP: "0.0.0.0"
      EPDG_CERT_FILE: "/certs/epdg.crt"
      EPDG_KEY_FILE: "/certs/epdg.key"

      # VPN 📄📄
      EPDG_VPN_MODE: "simple"

      # Diameter
      DIA_HOST: "epdg"
      DIA_REALM: "epc.mnc001.mcc001.3gppnetwork.org"
      HSS_HOST: "hss"
      HSS_IP: "10.74.0.21"
      HSS_PORT: "3868"

      # 📄📄📄
      LICENSE_SERVER_URL: "https://license.example.com/api"

      # 📄📄📄📄
      CONTROL_PANEL_PORT: "4000"

      # Prometheus 📄📄
      PROMETHEUS_PORT: "9568"
    ports:
      - "500:500/udp"
      - "4500:4500/udp"
      - "4000:4000"
      - "9568:9568"
    volumes:
      - ./certs:/certs:ro
    cap_add:
      - NET_ADMIN
```

URL	API	API
/dashboard	API	API
/sessions	API	API UE API
/diameter	Diameter API	Diameter API
/logs	API	API
/docs	API	API
/resources	API	BEAM VM API
/configuration	API	API

API

API OmniEPDG API

Table 1

Table 1: UE categories

Category	UE
Category 1	Category 1 UE
Category 2 (UL)	Category 2 UEs
Category 3 (DL)	Category 3 UEs
Diameter	Category 4 / Category 5

Table 1: UE categories (B, KB, MB, GB)

Table 2

Table 2: UE categories

- Category 1 - Category 1 UE
- Diameter** - Diameter UE
- Category 2 - Category 2 UE
- Category 3 - Category 3 UE

Table 3

Table 3: UE categories

VPN	GTP SIMPLE
IKEv2	500 (IKE), 4500 (NAT-T)
Diameter	Diameter
IP (IPv4)	IP CIDR VPN

 UE

OmniEPDG v0.1.0 Licensed to: Omnitouch
© 2020 Omnitouch

UE Sessions 1 Session 1 Active 8.53 KB / 12.17 KB

IMSI	UE IP	SOURCE	APN	STATUS	DURATION	TRAFFIC
	100.64.34.84	10.7.7.50:14500	*	Active	4m 50s	8.53 KB / 12.17 KB

SESSION	NETWORK & TIMING	TRAFFIC
IMSI	DNS	10.4.10.195, 10.4.10.196 Bytes In (UL) 8.53 KB
NAI	3gppnetwork.org P-CSCF	10.4.12.165 Bytes Out (DL) 12.17 KB
UE IP	100.64.34.84 Connected	2026-03-08 21:39:16 Packets In 63
Source	10.7.7.50:14500 Last Activity	2026-03-08 21:41:48 Packets Out 63
APN	* Duration	4m 50s
Child SA SPI	0x4E54838A	

Omnitouch

 UE

□□□□

□□□□□□□□

□	□□
IMSI	□□□□□□□□□□□□
UE IP	□□□ IPv4/IPv6 □□
SOURCE	UE □□□ IP □□□□NAT □□□
APN	□□□□□□□□
STATUS	□□□□□□□□□□/□□□□
DURATION	□□□□□□□□□□
TRAFFIC	□□/□□□□□□□□UL/DL□

□□□□□□

□□□□□□□□□□□□□□□□





□□	□□	□□
□□	□□	□□□□□□□□□□□□
□□□	□□	□□□□□□
□□□	□□	□□□□□□□□

□□□□

□□□□□□□□□□□□□□□□

□□□□□□□□ IMSI□NAI□□□□□□□□□□

□□□□

□□	□□
IMSI	□□□ IMSI □
NAI	□□□□□□□□3GPP □□□
UE IP	□□□ IPv4/IPv6 □□
Source	UE □□□ IP □□□□NAT □     □
APN	PDN □□□□□□□□
Child SA SPI	IPSec □ SA □□□□□□

□□□□□□□

項目	説明
DNS	UE が DNS を検索
P-CSCF	IMS ネットワークの P-CSCF と接続
Connected	接続が確立された状態
Last Activity	最後のアクティビティの時刻
Duration	接続が維持された期間

データ

項目	説明
Bytes In (UL)	UE が送信したバイト数
Bytes Out (DL)	UE が受信したバイト数
Packets In	UE が送信したパケット数
Packets Out	UE が受信したパケット数

備考

接続が確立された状態

- "P-CSCF" と接続
- P-CSCF と UE が接続

接続

接続が確立された状態

Diameter 配置

Diameter 設定は Diameter 設定 HSS 設定 SWx PGW 設定 S6b 設定

設定

設定

項目	設定
Peer	Diameter 設定 Origin-Host
Realm	Diameter 設定 Origin-Realm
IP 設定	設定 <code>protocol://ip:port</code>
設定	設定

設定

項目	設定	設定
設定	設定	Diameter 設定
設定	設定	設定
設定	設定	設定

設定

設定

- X 設定 - 設定
- Y 設定 - 設定

□□□□□

□□□□□□□□□□□□□□□□

□□	□□
□□□□	□□□□□□ local □□□□□□□□□□□□ remote □□□□□□□□□□
□□	□□□ tcp □ sctp
□□□□	□□□□ CER/CEA □□□□□□□□
□□□□□□□□	□□□□□□ Diameter □□□□ ID

□□□

□□□□□□□□□□□□□□□□

- "□□□□ Diameter □□□" □□ Diameter □□□
- "Diameter □□□" □□□□□□□□□□□□

□□□□

□□□□□□□□□□□□□□□□

□□□□

□□□□□□□□□□□□□□□□□□□□□□□□□□□□

□□□□

□□□□□□□□□□□□□□□□□□□□□□□□□□□□

□□	□□
□□□	□□□□□□□□□□
□□	□□□□□□□□□□□□□□
□□	□□□□□□□

□□□□

□□□□□□□□□□□□□□

□□	□□	□□
debug	□□	□□□□□□□□
info	□□	□□□□□□□□
warning	□□	□□□□
error	□□	□□□□

□□□□

□□□□□□□□□□□□□□□□□□

□□□	□□
□□□□	debug, info, warning, error
□□+	info, warning, error
□□+	warning, error
□□□	error

□□

□□□□□□□□□□

- □□□□□□□□□□□□
- □□□□□□□□
- □□□□□□□□□□

□□

□□	□□
□□/□□	□□□□□□□□/□
□□	□□□□□□□□□□
□□□□	□□□□□□□□□□□□

□□□□

- □□□□ 1000 □□□□□
- □□□□□□□□□□□□□□
- □□□□□□□□□□□□□□

□□□

□□□□□□□□□□□□

- "□□□□□□□□" □□
- □□□□□□□□□□□□□□

□□□□

□□□□□□□□□□□□□□□□

Markdown 00

000000 Markdown 000000000000

- 00000000
- 000000000000
- 00
- 000000000000
- 00000000

000000

000000 BEAM VM 000000000000 OTP 000000

□□□□

□□	□□
□□□□	BEAM VM □□□□□□
BEAM □□	□□□□□ Erlang/Elixir □□□□
□□□□	□□□□□□□□□□□□

□□□□□□□□□□

□□□□□□□ OTP □□□□□□□□□□□□

□□	□□
□□	OmniEPDG □□□□
□□	□□ Erlang/OTP □ Elixir □□□□

□□□□□□□□□□□□□□□□□□□□□□□□□□□□

□□□□

□□□□□□□□□□□□□□□□□□□□□□

□□□□

□□	□□
□□	□□ Mix □□□□□/□□□
Elixir □□	□□□□□ Elixir □□

□□□□□□

□□□□□□ OTP □□□□□□□□□□□□□□□□□□

- □□□□□□
- □□□□
- □□□□
- □□□□

OmniEPDG

OmniEPDG Prometheus Diameter HTTP Prometheus

-
-
- - IKEv2
 - EAP
 -
 - Diameter SWx
 - Diameter S6b
 -
 - ESP
 - IP
 - VM
- Prometheus
-
-

OmniEPDG

```
http://<host>:9568/metrics
```

Prometheus Prometheus Grafana

□□

□ config/runtime.exs □□❖❖□□□□

```
config :omniepdg,
  prometheus: %{
    port: 9568
  }
```

□□	□□	□□□	□□□□	□□
port	□□	9568	PROMETHEUS_PORT	/metrics □□□ HTTP □□

□□□□

IKEv2 □□□□

□□ SWu □□□ IKEv2 □□□□□□□□

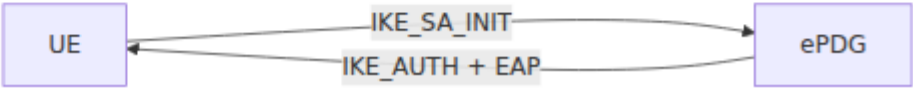
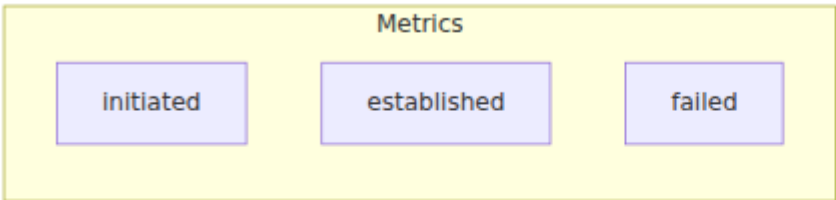

□□: epdg_ikev2_session_initiated_count
 □□: □□□
 □□: □□□ IKE_SA_INIT □□□□□□ UE □□□□□□□□□□

□□: epdg_ikev2_session_established_count
 □□: □□□
 □□: □□□□□ IKE SA □□□□□□□□ EAP-AKA □□□□□□□ SA □□□□□□□

log: epdg_ikev2_session_failed_count

log: log

log: IKE SA log

log:

- reason - log auth_failed log timeout log invalid_proposal log

EAP log

log RFC 4187 log EAP-AKA log OmniEPDG log RFC 5448 log EAP-AKA' log
log UE log NAI log

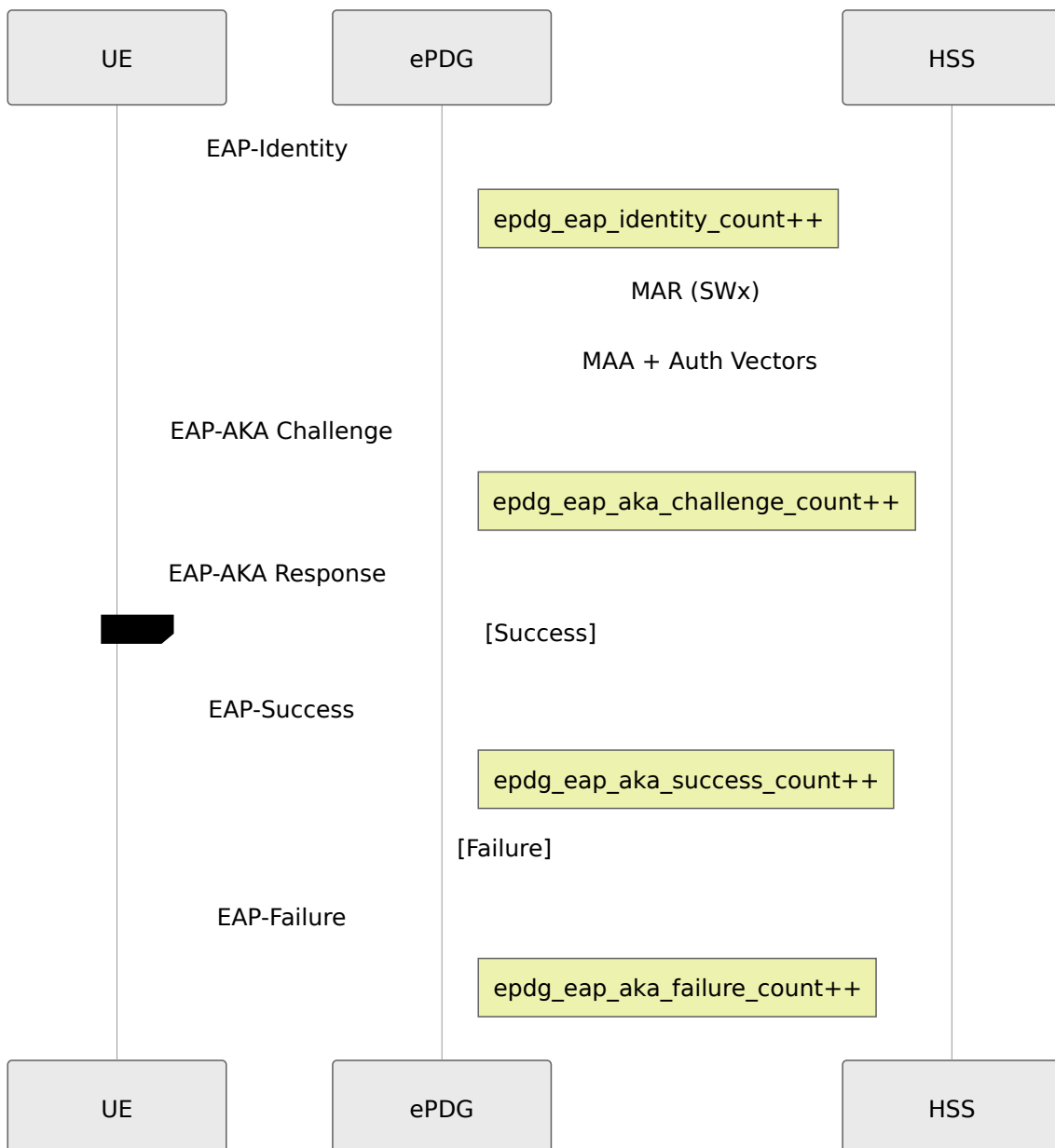

计数器: epdg_eap_identity_count

单位: 计数

描述: UE 发起 EAP-Identity 消息

计数器: epdg_eap_aka_challenge_count

单位: 计数

描述: UE 发起 EAP-AKA 挑战消息

计数器: epdg_eap_aka_success_count

单位: 计数

描述: EAP-AKA 认证成功

计数器: epdg_eap_aka_failure_count

单位: 计数

描述: EAP-AKA 认证失败

原因:

- reason - 认证失败原因: res_mismatch, invalid_identity, authentication_rejected
-

计数器: epdg_eap_aka_sync_failure_count

单位: 计数

描述: EAP-AKA 同步失败 (SQN) 与 USIM/HSS 不一致

计数器: epdg_auth_verification_failed_count

单位: 计数

计数器: epdg_auth_verification_failed_count

单位: 计数

描述: AUTH 验证失败

Diameter SWx

3GPP TS 29.273 ePDG HSS SWx

epdg_diameter_swx_mar_count

Count

Count HSS

Count

- result - success failure
-

epdg_diameter_swx_sar_count

Count

Count HSS

Count

- result - success failure
-

epdg_diameter_swx_mar_latency_ms

Count

MAR

50, 100, 250, 500, 1000, 2500 ms

epdg_diameter_swx_sar_latency_ms

Count

SAR

50, 100, 250, 500, 1000, 2500 ms

epdg_diameter_swx_pending_count

Count

Count SWx HSS

Diameter S6b

3GPP TS 29.273 AAA PGW S6b GTP

epdg_diameter_s6b_aar_count

:

: AA

:

- result - success failure
-

epdg_diameter_s6b_str_count

:

:

epdg_diameter_s6b_active_sessions_count

:

: S6b

PDN

epdg_session_created_count

:

:

:

- vpn_mode - VPN simple gtp
-

epdg_session_terminated_count

:

:

:

- reason - user_request timeout error admin

명: `epdg_sessions_active_count`

명: 명

명: 명명명명명명명명 5 명명명명

명: `epdg_sessions_by_state_count`

명: 명

명: 명 FSM 명명명명명

명:

- `state` - 명명명명명명 `init` `eap_identity` `eap_aka_challenge` `authenticated` `established`
-

명: `epdg_auth_duration_ms`

명: 명

명: 명 IKE_SA_INIT 명명명명명명명명명명명명명명

명: 100, 250, 500, 1000, 2500, 5000, 10000 ms

명: `epdg_session_duration_seconds`

명: 명

명: 명명명명명명명명명명

명: 60, 300, 900, 1800, 3600, 7200, 14400 seconds 1 명명 4 명

ESP 명명명명

명 RFC 4303 명 ESP 명명명명명

명: `epdg_esp_packets_in_count`

명: 명

명: 명명명명 ESP 명명명명 UE → 명명명명

명: `epdg_esp_packets_out_count`

명: 명

명: 명명명명 ESP 명명명명명명 → UE 명

名称: epdg_esp_bytes_in_total

单位: 字节

描述: ESP 字节数

名称: epdg_esp_bytes_out_total

单位: 字节

描述: ESP 字节数

IP 地址

VPN 地址 IP 地址

名称: epdg_ip_allocated_count

单位: 计数

描述: IP 地址

名称:

- type - 地址类型 ipv4 或 ipv6
-

名称: epdg_ip_released_count

单位: 计数

描述: IP 地址

名称:

- type - 地址类型 ipv4 或 ipv6
-

名称: epdg_ip_pool_allocated_count

单位: 计数

描述: IP 地址

名称: epdg_ip_pool_available_count

单位: 计数

描述: IP 地址

[[[vm_system_info_port_count

[[[]]

[[[]]

[[[vm_statistics_run_queue

[[[]]

[[[]]

Prometheus [[[]]

[[[]]

[[[]] OmniEPDG [[[]]] Prometheus `prometheus.yml` [[[]]

```
scrape_configs:  
  - job_name: 'omniepdg'  
    scrape_interval: 15s  
    static_configs:  
      - targets: ['epdg-host:9568']  
        labels:  
          instance: 'epdg-01'  
          environment: 'production'
```

[[[]]

[[[]] Kubernetes [[[]]]

```

scrape_configs:
  - job_name: 'omniepdg'
    kubernetes_sd_configs:
      - role: pod
    relabel_configs:
      - source_labels: [__meta_kubernetes_pod_label_app]
        action: keep
        regex: omniepdg
      - source_labels:
          [__meta_kubernetes_pod_annotation_prometheus_io_port]
        action: replace
        target_label: __address__
        regex: (.+)
        replacement: ${1}:9568

```

□□□□

□□□□□□□□

```

# 5 □□□□□□□□
sum(rate(epdg_eap_aka_success_count[5m]))
/
(sum(rate(epdg_eap_aka_success_count[5m])) +
sum(rate(epdg_eap_aka_failure_count[5m])))

```

□□□□□□

```

# □□□□□□□□
rate(epdg_ikev2_session_established_count[5m])

```

□□□□□□ (p95)

```

histogram_quantile(0.95,
sum(rate(epdg_auth_duration_ms_bucket[5m])) by (le))

```

HSS 指标 (p99)

```
histogram_quantile(0.99,  
sum(rate(epdg_diameter_swx_mar_latency_ms_bucket[5m])) by (le))
```

指标

```
epdg_sessions_active_count
```

IP 指标

```
epdg_ip_pool_utilization_ratio * 100
```

ESP 指标

```
# 吞吐量  
rate(epdg_esp_bytes_in_total[5m])  
  
# 数据包  
rate(epdg_esp_packets_in_count[5m]) +  
rate(epdg_esp_packets_out_count[5m])
```

指标

```
# EAP 失败  
sum by (reason) (rate(epdg_eap_aka_failure_count[5m]))  
  
# 会话终止  
sum by (reason) (rate(epdg_session_terminated_count[5m]))
```



OmniEPDG Prometheus

```

groups:
- name: omniepdg
  rules:
    # EAP-AKA
    - alert: OmniEPDGHighAuthFailureRate
      expr: |
        sum(rate(epdg_eap_aka_failure_count[5m]))
        /
        (sum(rate(epdg_eap_aka_success_count[5m])) +
        sum(rate(epdg_eap_aka_failure_count[5m])))
        > 0.1
      for: 5m
      labels:
        severity: warning
      annotations:
        summary: "EAP-AKA "
        description: "5  {{{ $value |
humanizePercentage }}"

    # IP
    - alert: OmniEPDGIPPoolLow
      expr: epdg_ip_pool_utilization_ratio > 0.9
      for: 5m
      labels:
        severity: warning
      annotations:
        summary: "IP 90%"
        description: "IP {{{ $value | humanizePercentage
}}"

    # IP
    - alert: OmniEPDGIPPoolExhausted
      expr: epdg_ip_pool_available_count == 0
      for: 1m
      labels:
        severity: critical
      annotations:
        summary: "IP "
        description: "IP "

    # HSS
    - alert: OmniEPDGHSSLatencyHigh
      expr: |

```

```

        histogram_quantile(0.95,
sum(rate(epdg_diameter_swx_mar_latency_ms_bucket[5m])) by (le))
    > 1000
    for: 5m
    labels:
      severity: warning
    annotations:
      summary: "HSS (SWx) 🚨"
      description: "95 🚨 MAR 🚨 {{ $value }}ms"

# 🚨 SWx 🚨🚨
- alert: OmniEPDGSWxBacklog
  expr: epdg_diameter_swx_pending_count > 100
  for: 2m
  labels:
    severity: warning
  annotations:
    summary: "SWx 🚨🚨"
    description: "{{ $value }} 🚨🚨 SWx 🚨"

# VM 🚨🚨
- alert: OmniEPDGMemoryHigh
  expr: vm_memory_total > 2147483648
  for: 10m
  labels:
    severity: warning
  annotations:
    summary: "OmniEPDG 🚨🚨🚨"
    description: "VM 🚨🚨🚨 {{ $value | humanize1024 }}"

# 🚨🚨🚨🚨
- alert: OmniEPDGSchedulerOverload
  expr: vm_statistics_run_queue > 10
  for: 5m
  labels:
    severity: warning
  annotations:
    summary: "Erlang 🚨🚨🚨🚨🚨"
    description: "🚨🚨🚨🚨 {{ $value }}🚨🚨 CPU 🚨"

# 🚨🚨🚨🚨🚨🚨🚨
- alert: OmniEPDGNoSessions
  expr: epdg_sessions_active_count == 0 and
epdg_ikev2_session_initiated_count > 0

```

```

for: 10m
labels:
  severity: warning
annotations:
  summary: "速率过高"
  description: "速率过高"

# 速率过高
- alert: OmniEPDGHighRateLimiting
  expr: rate(epdg_auth_rate_limited_count[5m]) > 10
  for: 5m
  labels:
    severity: warning
  annotations:
    summary: "速率过高"
    description: "{{ $value | printf \"%.1f\" }} 速率过高"

"

# GeoIP 速率过高
- alert: OmniEPDGGeoIPBlockingSpike
  expr: |
    rate(epdg_auth_geoip_blocked_count[5m]) > 5
  for: 5m
  labels:
    severity: warning
  annotations:
    summary: "GeoIP 速率过高"
    description: "{{ $value | printf \"%.1f\" }} 速率过高 GeoIP 速率过高"

"

# ESP 速率过高
- alert: OmniEPDGReplayAttack
  expr: rate(epdg_esp_replay_detected_count[5m]) > 0
  for: 2m
  labels:
    severity: warning
  annotations:
    summary: "ESP 速率过高"
    description: "{{ $value | printf \"%.1f\" }} 速率过高"

# AUTH 速率过高 MITM
- alert: OmniEPDGAuthVerificationFailures
  expr: rate(epdg_auth_verification_failed_count[5m]) > 0
  for: 2m

```

```
labels:  
  severity: critical  
annotations:  
  summary: "AUTH AUTH AUTH AUTH"  
  description: "AUTH AUTH AUTH AUTH"
```

□□□□

□□□□□□□□□□□□□□□□□□□□

□□	□□	□□
4000	TCP	□□□□□□□□ (HTTP)
443	TCP	□□□□□□□□ (HTTPS, □□)
9568	TCP	Prometheus □□□□

DNS □□

ePDG □□ DNS □□

□□□□□□ 3GPP TS 23.003 □□□□□□□□ DNS □□□□□□ ePDG□FQDN □□□□

```
epdg.epc.mnc<MNC>.mcc<MCC>.pub.3gppnetwork.org
```

□□□

- <MCC> □ 3 □□□□□□□□□□□□□□□□□□□□ 505□
- <MNC> □ 2 □ 3 □□□□□□□□□□□□□□□□□□□□ 3 □□□□□□ 001□

DNS □□□□□□ OmniEPDG □□ IP □□□ **A** □□□□ IPv6 □ AAAA □□□□

```
epdg.epc.mnc999.mcc999.pub.3gppnetwork.org. IN A 203.0.113.10
```

□□□□□□

ePDG □ TLS □□□□□□□□□□□□□□□□□□□□ ePDG FQDN □□□□□□□□□□ (SAN)□□ IKEv2 □□□□□□□□ □□ □□□□□□

□□□□

- SAN □□□□ ePDG □□ FQDN□□□□
`epdg.epc.mnc001.mcc001.pub.3gppnetwork.org` □
- □□□□□□□□ CA □□□□□□□□
- □□ RSA 2048 □□ ECDSA P-256

Diameter □ DNS

□□□□ Diameter □□□□□□ DNS NAPTR/SRV □□□□□□ RFC 6408□□□□□□

```
epc.mnc<MNC>.mcc<MCC>.3gppnetwork.org
```

□□□

```
epc.mnc001.mcc001.3gppnetwork.org
```

□□□□

- UE □□□□□□□□ NAI□□□□□□□□□□
- Diameter Origin-Realm □ Destination-Realm AVP
- Diameter □□□□

□□□□

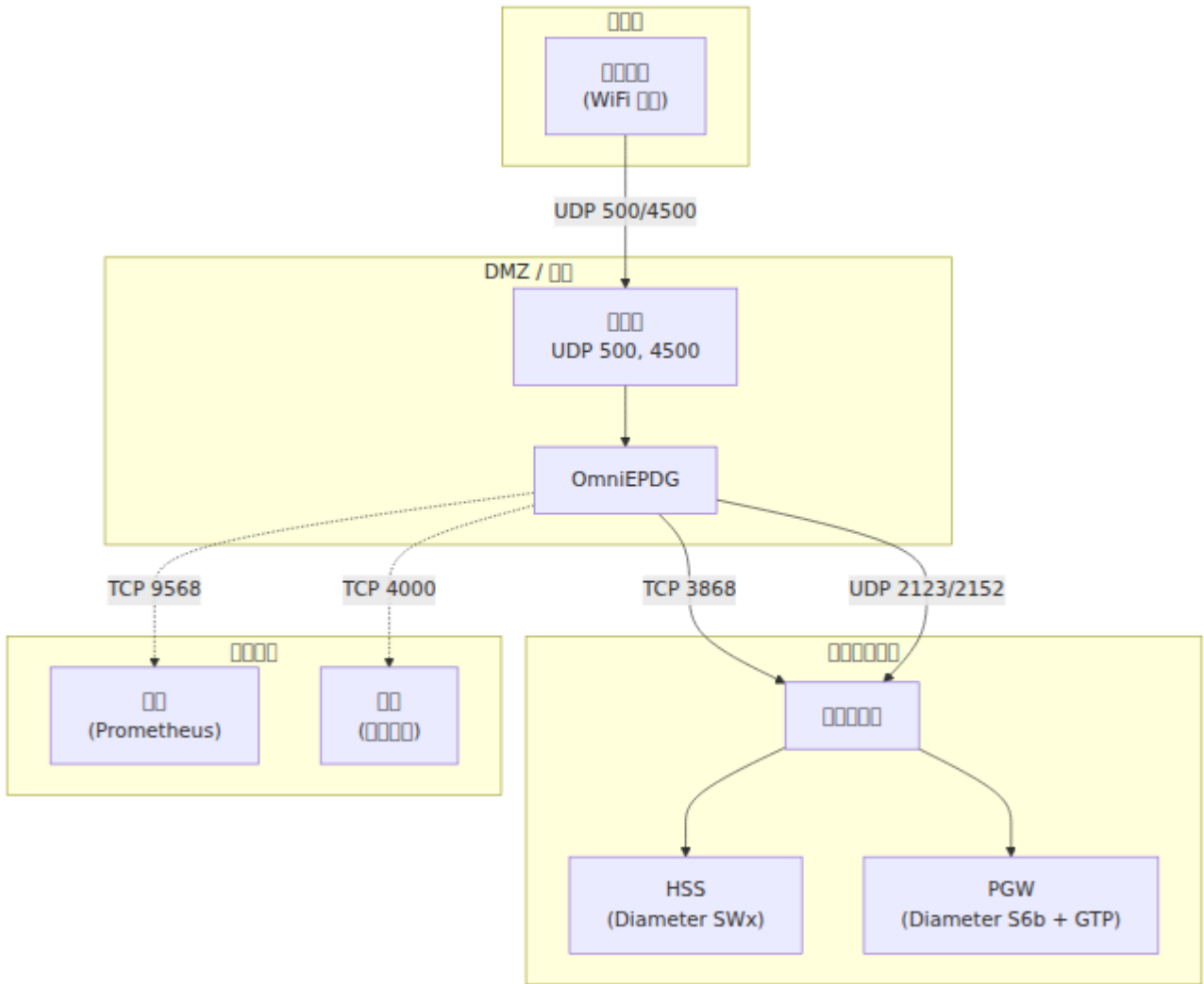

DNS □□□□

□□□□□□ WiFi □□□□□□□□ DNS □□□

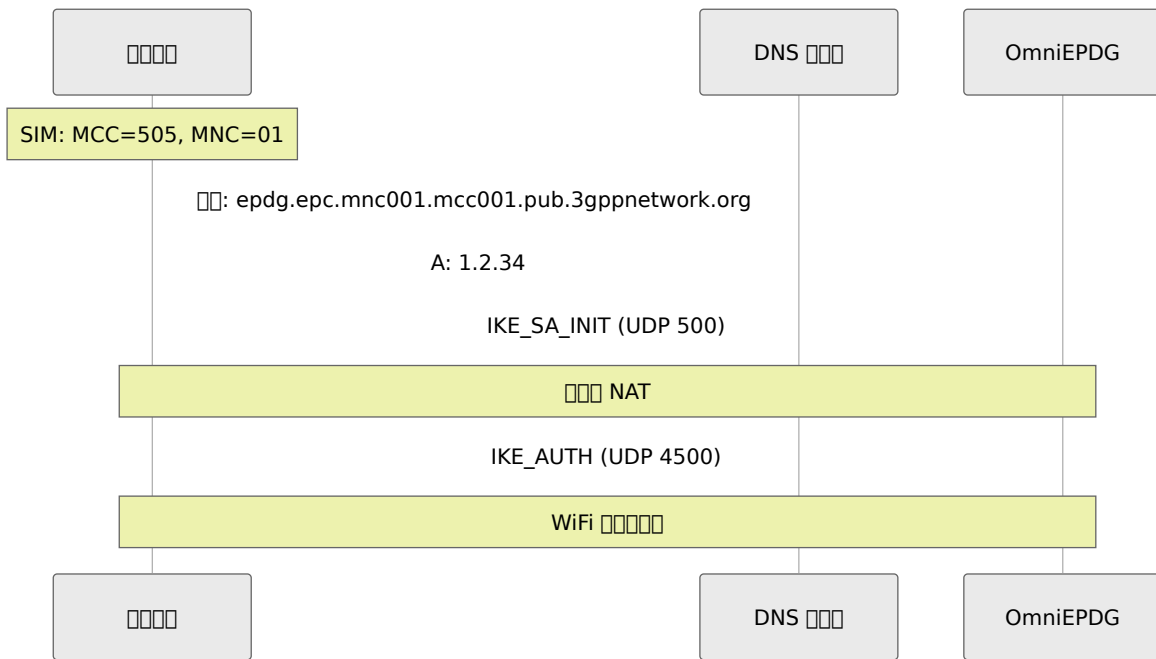

IP

IP

- UDP 500 → OmniEPDG → IP
- UDP 4500 → OmniEPDG → IP
- DNS A: `epdg.epc.mnc<MNC>.mcc<MCC>.pub.3gppnetwork.org` → ePDG → IP
- SAN → TLS → IP

IP

- TCP 3868 → OmniEPDG → HSS/DRA → IP
- TCP 3868 → OmniEPDG → PGW/AAA → GTP → IP
- UDP 2123 → OmniEPDG → PGW → GTP → IP
- UDP 2152 → OmniEPDG → PGW → GTP → IP

IP

- TCP 4000/443 → IP

TCP 9568 0000000000

0000

- [3GPP TS 23.003](#) - 00000000 (ePDG FQDN 00)
- [3GPP TS 23.402](#) - 0 3GPP 00000000
- [RFC 7296](#) - IKEv2 00
- [RFC 3948](#) - IPsec ESP 0000 UDP 00 (NAT-T)
- [RFC 6733](#) - Diameter 0000

IMSI

参数	单位	默认值	描述
auth_rate_limit_per_imsi	个	5	每个 IMSI 允许的认证速率 IP地址限制
auth_rate_limit_imsi_window_ms	毫秒	60000	每个 IMSI 认证的窗口时间
auth_rate_limit_imsi_block_ms	毫秒	600000	每个 IMSI 认证的阻塞时间 10 个 IP 地址限制

配置

配置 IP/IMSI 认证速率限制

配置

配置

配置

```
config :omniepdg,
  auth_rate_limit_per_ip: 5,
  auth_rate_limit_ip_window_ms: 120_000, # 2 分钟
  auth_rate_limit_ip_block_ms: 900_000, # 15 分钟

  auth_rate_limit_per_imsi: 3,
  auth_rate_limit_imsi_window_ms: 120_000,
  auth_rate_limit_imsi_block_ms: 1_800_000 # 30 分钟
```

配置 2 个 IP 地址限制 IMSI 每个 5 个认证速率限制 15-30 分钟

MaxMind GeoLite2 安裝

GeoIP 安裝 MaxMind GeoLite2 資料庫 IP 地址

安裝 GeoIP

1. 安裝 MaxMind GeoLite2 資料庫
2. 安裝 GeoLite2-Country.mmdb 資料庫
3. 將資料庫複製到 /etc/omniepdg/GeoLite2-Country.mmdb
4. 安裝 GeoIP

配置

```
config :omniepdg,  
  # 安裝 GeoIP  
  geip_enabled: true,  
  
  # MaxMind 資料庫  
  geip_database_path: "/etc/omniepdg/GeoLite2-Country.mmdb",  
  
  # 安裝模式  
  geip_mode: :whitelist,  
  
  # 安裝 ISO 3166-1 alpha-2 代碼  
  geip_countries: ["AU", "NZ"],  
  
  # 安裝 IP  
  geip_allow_unknown: false,  
  
  # 安裝 fail-open  
  geip_fail_open: true
```

00

00	00	00	00	00
<code>geop_enabled</code>	00	00	<code>false</code>	00000000 GeoIP 00000000 00 <code>false</code> 0000 0 IP 0000000000 0000
<code>geop_database_path</code>	00	00	<code>"/etc/omniepdg/GeoLite2-Country.mmdb"</code>	MaxMind GeoLite2 0000 000000000000 MMDB0
<code>geop_mode</code>	00	00	<code>:whitelist</code>	000000 00 <code>:whitelist</code> 000000000000 <code>:blacklist</code> 00 000000000000 0000
<code>geop_countries</code>	00	00	<code>[]</code>	ISO 3166-1 alpha-2 000000 0000000000 <code>geop_mode</code> 0
<code>geop_allow_unknown</code>	00	00	0000	00000000000000 0 IP 00000000 IP000000000000 00000000 <code>false</code> 00000000 000000 <code>true</code> 0
<code>geop_fail_open</code>	00	00	<code>true</code>	GeoIP 00000000 0000000000

項目	項目	項目	項目
			<input type="checkbox"/> true 有効にする <input type="checkbox"/> false 無効にする

設定

設定項目 **WiFi** の設定

設定項目のデフォルト値

```
config :omniepdg,
  geoip_enabled: true,
  geoip_mode: :whitelist,
  geoip_countries: ["AU", "NZ", "FJ"] # 許可する国
```

設定項目のデフォルト値 IP の UE 設定

設定項目 WiFi の設定

設定項目

設定項目   設定項目

```
config :omniepdg,
  geoip_enabled: true,
  geoip_mode: :blacklist,
  geoip_countries: ["CN", "RU", "KP", "IR"] # 許可する国
```

設定項目 UE の設定

設定項目

IP Whitelist

IP Whitelist

- IP 10.x.x.x 192.168.x.x
- IP
- Tor VPN

`geoiip_allow_unknown`

	<code>geoiip_allow_unknown</code>	
	<code>false</code>	= =
	<code>true</code>	= =

```
config :omniepdg,  
  geoiip_mode: :whitelist,  
  geoiip_allow_unknown: true # IP
```

GeoIP

MaxMind GeoLite2

1. `GeoLite2-Country.mmdb`
- 2.
- 3.

□□□□□□

□□	□□	□□	□□
AU	□□□□	US	□□
NZ	□□□	GB	□□
CA	□□□	DE	□□
FR	□□	JP	□□
SG	□□□	HK	□□
IN	□□	CN	□□

□□□□ [ISO 3166-1 alpha-2](#)

□□□□

□□□□□□□□

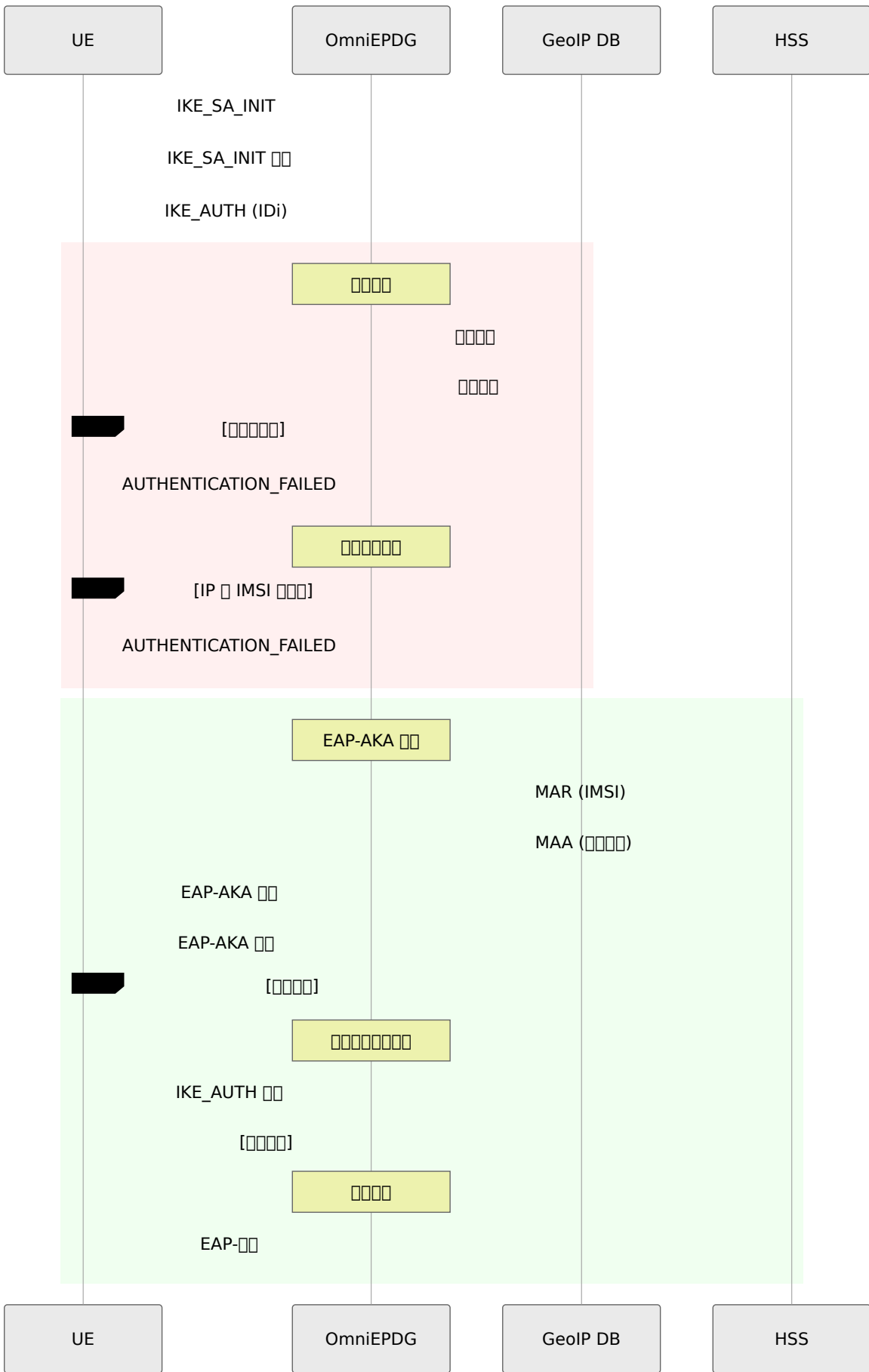

□□

□□□□□□

□□: `epdg_auth_rate_limited_count` □□: □□□ □□: □□□□□□□□□□□□□□ □□:

- `type` - □□□□□ `ip` □IP □□□□□□ `imsi` □IMSI □□□□□

□□□□□

```
# □□□□□□□□□□
rate(epdg_auth_rate_limited_count[1m])

# □□□□□□
sum by (type) (rate(epdg_auth_rate_limited_count[5m]))

# □□□□□□□□□□□□
rate(epdg_auth_rate_limited_count[5m]) > 10
```

GeoIP □□

□□: `epdg_auth_geoip_blocked_count` □□: □□□ □□: □ GeoIP □□□□□□□□□□ □□:

- `country` - ISO 3166-1 alpha-2 □□□□□□ □□□□□□ □□□□□□□□ IP

□□□□□

```
# □□□□□ GeoIP □□
rate(epdg_auth_geoip_blocked_count[1m])

# □□□□□□□□□□
topk(10, sum by (country) (epdg_auth_geoip_blocked_count))

# □□□□□□□□□□□□□□
increase(epdg_auth_geoip_blocked_count{country="XX"}[1h]) > 100
```



□□□□

□□□□□□

□□□□□□

□□: □□□□□□□□□□□□

□□□□:

- □□□□□□□□□□
- □□□□□□□□□□□□□□□
- □□□□□□□□□□

□□□□:

1. □□□□□□ IP/IMSI □□□□
2. □□□□□□□□□□□□□□
3. □□□□□□□□□□□□□□

□□□□□□□□□□

□□: `epdg_auth_rate_limited_count` □□□□

□□□□:

- □□□□□□□□□□
- □□□□□ UE □□□□□□
- □□□□□□

□□□□:

1. □□□□□□□ IP □□□□□□
2. □□□□□□□□□□ IP □□□□□□
3. □□□□□□□□□□□□□□ HSS □□

GeoIP 設定

設定内容

設定: GeoIP 設定 UE 設定

設定:

- 設定内容
- 設定内容
- `geip_allow_unknown: false` 設定内容 IP

設定:

1. 設定内容
2. 設定内容2 設定
3. 設定/設定 `geip_allow_unknown: true`
4. 設定内容 GeoIP 設定

GeoIP 設定

設定: 設定内容“GeoIP 設定”

設定:

- 設定内容
- 設定内容
- 設定内容 MMDB 設定

設定:

1. 設定 `ls -la /etc/omniepdg/GeoLite2-Country.mmdb`
2. 設定 `chmod 644 /etc/omniepdg/GeoLite2-Country.mmdb`
3. 設定 MaxMind 設定内容

設定内容

設定: 設定内容

□□□□:

- VPN/□□□ IP □□□□□□□□
- GeolP □□□□□
- □□□□□□□□□□

□□□□:

1. □□ GeolP □□□□□□□□
2. □□□□□□□□ IP □□□□□
3. □□□□□□□□□□□□□□□□□□

OmniEPDG

OmniEPDG

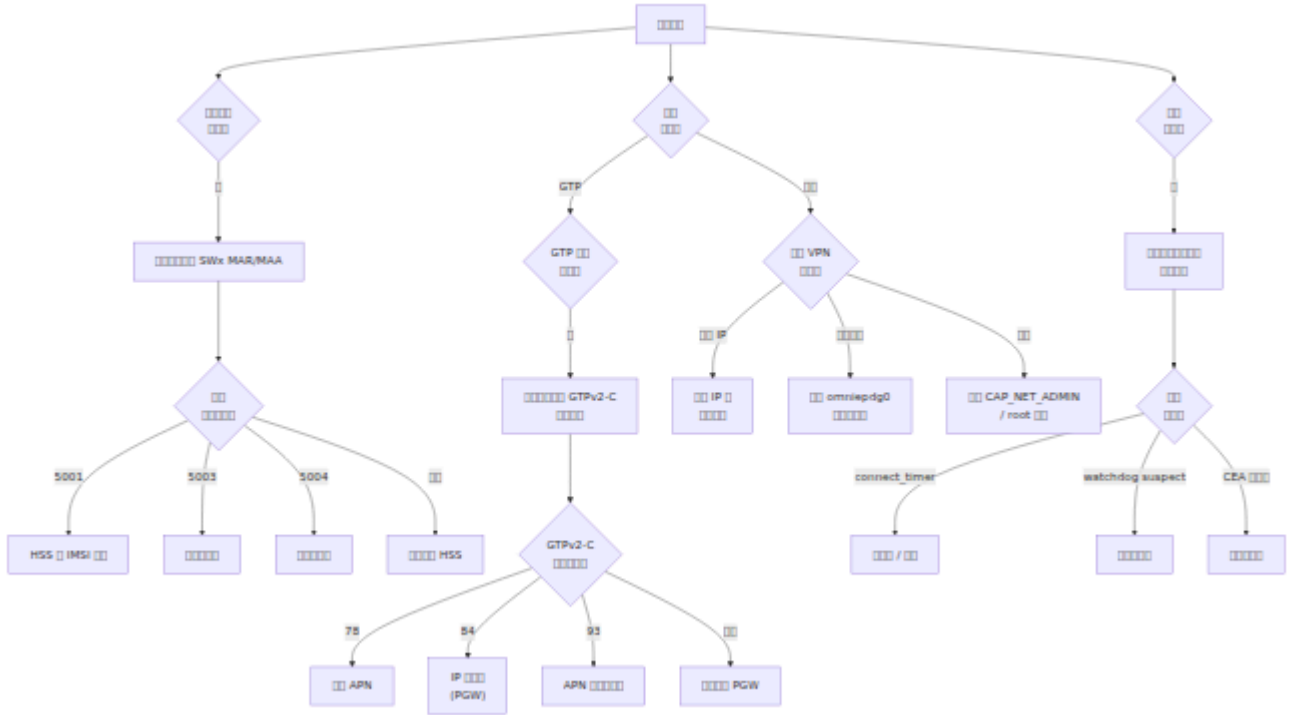

OmniEPDG `log/`

파일	내용	설명
log/console.log	콘솔 로그	디버깅용 로그
log/error.log	에러 로그	에러 발생 시 기록되는 로그
log/crash.log	OTP 에러 로그	OTP 관련 에러 로그
log/erlang.log	Erlang 에러 로그	Erlang/OTP 에러 로그

이벤트

이벤트 목록

- peer_up - 연결 성공 이벤트
- peer_down - 연결 실패 이벤트

UE FSM 이벤트

- ue_fsm state_<name> event=<event> - FSM 상태 변경 이벤트
- ue_fsm init(<IMSI>) - 초기화 FSM 이벤트
- terminating epdg_ue_fsm with reason <reason> - FSM 종료 이벤트

타이머

- Timeout swm_der_timeout - SWm DER 타이머
- Timeout create_session_timeout - GTPv2-C 세션 생성 타이머
- Timeout s2b_delete_session_timeout - GTPv2-C 세션 삭제 타이머
- Timeout cancel_location_timeout - 위치 취소 타이머

이벤트

HSS 이벤트 (SWx)

이벤트 목록은 HSS 관련 로그에서 확인 가능합니다.

□□□□

- □□□□ OmniEPDG □ HSS □□□ SCTP □□ 3868
- □□□□ `dia_swx_remote_ip` □ `dia_swx_remote_port` □□□
- HSS □□□□□□□□□□
- □□□□□□□□ SCTP□□□□□□□□□□ SCTP□
- Origin-Host □ Origin-Realm □□□□□ CEA □□

□□□□

1. □□□ HSS IP □□□□□□□□□□
2. □□ `dia_swx_remote_ip` □ `dia_swx_remote_port` □ HSS □□□□
3. □□□□□□□□□□ SCTP □□□□□ SCTP □□□□□ `dia_swx_proto` □□□ `tcp` □□□□
4. □□ `dia_swx_origin_host` □□□□□ FQDN□□□□ HSS □□□□□
5. □□ HSS □□□□□□□□ CER/CEA □□□□□□□□

PGW □□□□ (S6b)

□□□□□□□□□□ GTP □□□□□□□□ S6b AAR □ PGW □□□□□□□□□□□□ S6b peer_up □□□

□□□□

- PGW □□□□□□□□ OmniEPDG □ S6b □□□
- □□□□□□□□ OmniEPDG □ S6b □□□□□□□□ SCTP □□ 3868
- `dia_s6b_local_ip` □ PGW □□□□
- Origin-Host □ Origin-Realm □□□

□□□□

1. □□ PGW □□□□□□□□□□ OmniEPDG □ `dia_s6b_local_ip:dia_s6b_local_port`
2. □□ S6b □□□□□□□□□□ PGW □□□□
3. □□□□□□□□□□□□□□ S6b □□□□□□ 3868 □□□□□ SCTP
4. □□ `dia_s6b_origin_host` □ `dia_s6b_origin_realm` □ PGW □□□□□

□□□□□□□□

□□□□□□□□□□□□□□□□□□□□□□□□□□□□ SUSPECT □ DOWN □□□

□□□□

- □□□□ WiFi □□□□□□
- APN □□□□□□□□
- □□□□□□□□

□□□□

1. □□ HSS □□□□□□□□□□
2. □□ WiFi □□ / ePDG □□□□□□□□□□
3. □□□□ APN □□□□□□□□ APN □□□

□□□□ (□□ **5004**)

□□□□□□□□□□□□□□□□□□ SWx MAA □ SAA □□□ 5004□

□□□□

- HSS □□□□□□□□□□□□
- □□□□□□□□□□ WiFi □□

□□□□

1. □□ HSS □□□□□□□□□□ HPLMN/VPLMN □□
2. □□□□□□□□□□□□ WiFi □□

□□□□□□

□□□□□□□□□□□□ 10 □□□□□□□□□□ Timeout swm_der_timeout □
state_wait_auth_resp □□

□□□□

- HSS □ 10 □□□□□□ SWx MAR
- SWx □□□□□□□□□□□□
- HSS □□

□□□□

1. HSS
2. SWx OKAY SUSPECT DOWN
3. `dia_swx_transmit_timer` HSS

EAP-AKA

"type_mismatch" UE EAP

- UE EAP-AKA EAP-AKA'
- HSS EAP

3GPP TS 23.003 NAI

- EAP-AKA
- EAP-AKA'

OmniEPDG UE WiFi UE EAP-AKA

1. UE NAI
2. HSS
3. SIM

EAP-AKA RES

"RES mismatch" "res_mismatch"

- SIM
- UE
- HSS

1. SIM 注册
2. HSS 返回 RAND, AUTN, XRES, CK, IK
3. XRES 与 RES 对比
4. SIM 注册成功, HSS 返回 Ki, OP/OPc

GTP 隧道 GTP 隧道

PGW 隧道

PGW 隧道 GTPv2-C 隧道

隧道

隧道 ID	隧道名称	隧道描述
78	APN 隧道	APN 隧道 PGW 隧道
82	RAT 隧道	PGW 隧道 WiFi 3GPP 隧道
84	隧道	PGW IP 隧道
92	隧道	PGW 隧道 S6b 隧道
93	APN 隧道	PGW 隧道 APN 隧道
96	IMSI/IMEI 隧道	PGW 隧道 S6b 隧道
113	APN 隧道	APN 隧道 PGW 隧道
120	GTP-C 隧道	PGW 隧道

隧道

隧道 10 隧道 Timeout create_session_timeout 隧道 state_wait_create_session_resp 隧道

VPN 配置 VPN 配置

TUN 配置

OmniEPDG 配置 `omniepdg0` 配置 `simple_vpn_route` 配置

配置

- OmniEPDG 配置 `CAP_NET_ADMIN` 配置 `root` 配置
- TUN/TAP 配置
- 配置 `omniepdg0` 配置

配置

1. 配置 TUN 配置 `lsmod | grep tun`
2. 配置 OmniEPDG 配置 TUN 配置
3. 配置 `omniepdg0` 配置 `ip link show omniepdg0`
4. 配置 `log/crash.log` 配置

IP 配置

配置 `simple_vpn_pool` 配置 IP 配置

配置

- 配置 CIDR 配置
- 配置 IP 配置
- 配置

配置

1. 配置 `epdg_ue_fsm` 配置
2. 配置 `terminating` 配置
3. 配置 `simple_vpn_pool_ipv4` 配置 CIDR 配置
4. 配置 `log/crash.log` 配置 FSM 配置 IP 配置

