

OmniPGW 部署

runtime.exs 部署

OmniTouch 部署

部署

- 部署
 - 部署
 - 部署
 - Diameter/Gx 部署
 - S5/S8 部署
 - Sxb/PFCP 部署
 - UPF 部署
 - UPF 部署
 - DNS 部署
 - 部署
 - UE IP 部署
 - PCO 部署
 - Web UI 部署
 - 部署
 - 部署
-

部署

OmniPGW 部署 `config/runtime.exs` 部署 部署 部署

□□□□

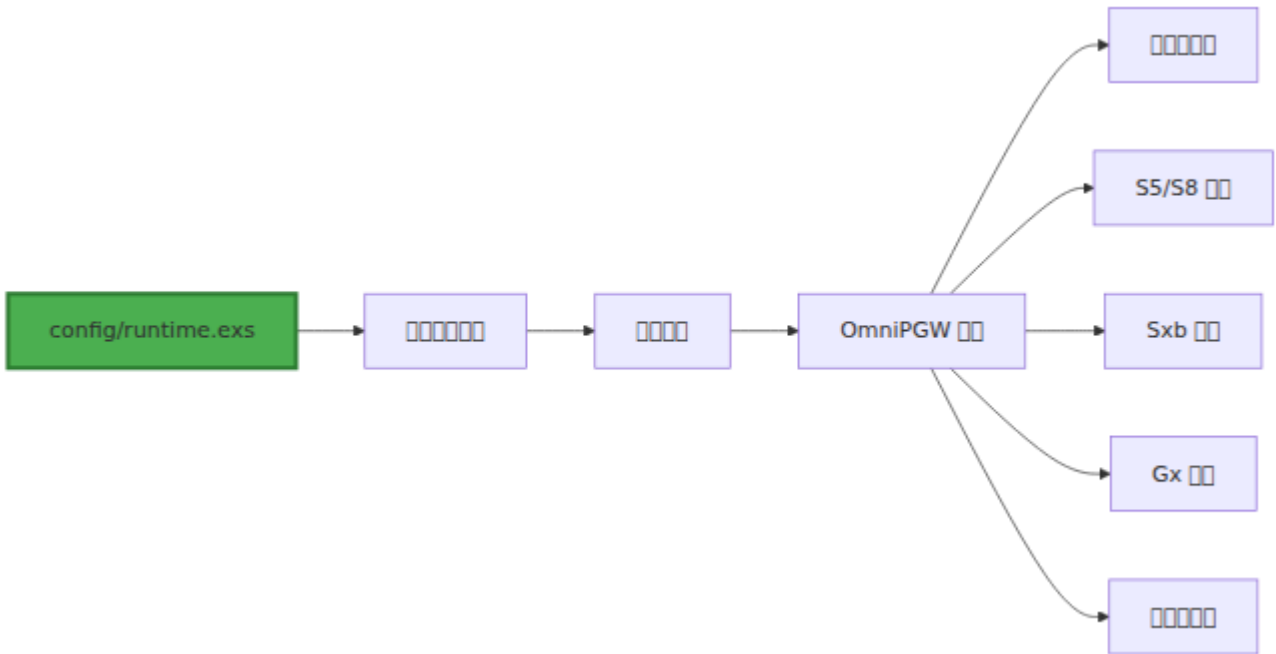

□□□□

- □□□□□□ - □□□□□□□□□□
- □□□□ - □□□□□□□□
- □□□□□□ - □□□□□□□□□□
- □□□□□□ - □□□□□□□□□□

□□□□□□□□

□□□□

```
pgw_c/  
├─ config/  
│   ├── config.exs      # □□□□□□□□ runtime.exs□  
│   ├── dev.exs        # □□□□□□□□  
│   ├── prod.exs       # □□□□□□□□  
│   └─ runtime.exs     # ← □□□□□□□□
```

□□□□

```
# config/runtime.exs
import Config

config :logger, level: :info

config :pgw_c,
  metrics: %{...},
  diameter: %{...},
  s5s8: %{...},
  sxb: %{...},
  ue: %{...},
  pco: %{...}
```

□□□□

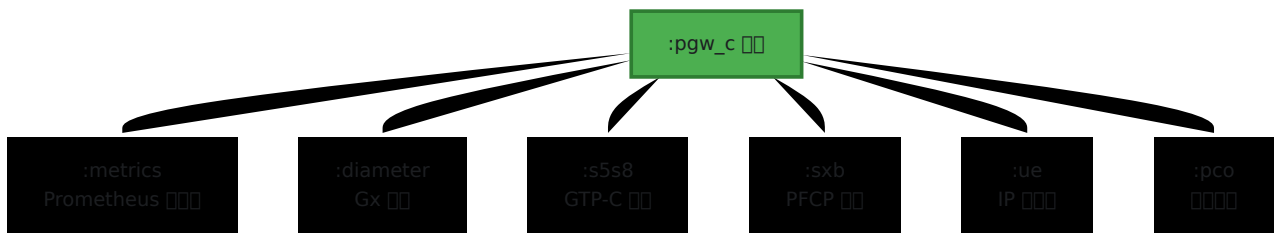

□□□□

□□

□□ Prometheus □□□□□□□□ OmniPGW□

□□□

```
config :pgw_c,  
  metrics: %{  
    # □□/□□□□□□□□  
    enabled: true,  
  
    # □□ HTTP □□□□ IP □□  
    ip_address: "0.0.0.0",  
  
    # □□□□□□□□  
    port: 9090,  
  
    # □□□□□□□□□□□□  
    registry_poll_period_ms: 10_000  
  }
```

□□

□□	□□	□□□	□□
enabled	□□□	true	□□□□□□□□
ip_address	□□□ □IP□	"0.0.0.0"	□□□□□0.0.0.0 = □□□□□□
port	□□	9090	HTTP □□□□ /metrics □□
registry_poll_period_ms	□□	10_000	□□□□□□□□□□□□

□□

□□ - □□□□□ IP□

```
metrics: %{
  enabled: true,
  ip_address: "10.0.0.20", # 10.0.0.20
  port: 9090,
  registry_poll_period_ms: 5_000 # 5 000ms
}
```

10 - 10.0.0.20

```
metrics: %{
  enabled: true,
  ip_address: "127.0.0.1",
  port: 42069, # 42069
  registry_poll_period_ms: 10_000
}
```

10.0.0.1

```
metrics: %{
  enabled: false
}
```

10.0.0.1

```
# 10.0.0.1
curl http://<ip_address>:<port>/metrics

# 10
curl http://10.0.0.20:9090/metrics
```

10 10.0.0.20 10.0.0.1

Diameter/Gx `g`

`g`

`g` Diameter `g` Gx `g` PCRF `g`

`g`

```
config :pgw_c,  
  diameter: %{  
    # g Diameter g IP g  
    listen_ip: "0.0.0.0",  
  
    # OmniPGW g Diameter gOrigin-Hostg  
    host: "omnipgw.epc.mnc001.mcc001.3gppnetwork.org",  
  
    # OmniPGW g Diameter gOrigin-Realmg  
    realm: "epc.mnc001.mcc001.3gppnetwork.org",  
  
    # PCRF g  
    peer_list: [  
      %{  
        # PCRF Diameter g  
        host: "pcrf.epc.mnc001.mcc001.3gppnetwork.org",  
  
        # PCRF g  
        realm: "epc.mnc001.mcc001.3gppnetwork.org",  
  
        # PCRF IP g  
        ip: "10.0.0.30",  
  
        # g PCRF g  
        initiate_connection: true  
      }  
    ]  
  }  
}
```

□□

□□	□□	□□	□□
listen_ip	□□□□IP□	□	Diameter □□□□
host	□□□□FQDN□	□	OmniPGW □ Origin-Host□□□□ FQDN□
realm	□□□□□□	□	OmniPGW □ Origin-Realm
peer_list	□□	□	PCRF □□□□□

□□□□□□

□□	□□	□□	□□
host	□□□□FQDN□	□	PCRF Diameter □□
realm	□□□□□□	□	PCRF □□
ip	□□□□IP□	□	PCRF IP □□
initiate_connection	□□□	□	OmniPGW □□□□□ PCRF

FQDN □□

Diameter □□□□ FQDN□

```
# □□  
host: "omnipgw.epc.mnc001.mcc001.3gppnetwork.org"  
  
# □□  
host: "omnipgw"           # □□ FQDN  
host: "10.0.0.20"        # □□□ IP
```

3GPP □□□

```
<hostname>.epc.mnc<MNC>.mcc<MCC>.3gppnetwork.org
```

```
□□□
```

- omnipgw.epc.mnc001.mcc001.3gppnetwork.org (MCC=001, MNC=001)
- pgw-c.epc.mnc260.mcc310.3gppnetwork.org (MCC=310, MNC=260 - □□ T-Mobile)

```
□□
```

```
□□ PCRF□
```

```
diameter: %{  
  listen_ip: "0.0.0.0",  
  host: "omnipgw.epc.mnc001.mcc001.3gppnetwork.org",  
  realm: "epc.mnc001.mcc001.3gppnetwork.org",  
  peer_list: [  
    %{  
      host: "pcrf.epc.mnc001.mcc001.3gppnetwork.org",  
      realm: "epc.mnc001.mcc001.3gppnetwork.org",  
      ip: "10.0.0.30",  
      initiate_connection: true  
    }  
  ]  
}
```

```
□□ PCRF□□□□□
```

```
diameter: %{
  listen_ip: "0.0.0.0",
  host: "omnipgw.epc.mnc001.mcc001.3gppnetwork.org",
  realm: "epc.mnc001.mcc001.3gppnetwork.org",
  peer_list: [
    %{
      host: "pcrf-primary.epc.mnc001.mcc001.3gppnetwork.org",
      realm: "epc.mnc001.mcc001.3gppnetwork.org",
      ip: "10.0.1.30",
      initiate_connection: true
    },
    %{
      host: "pcrf-backup.epc.mnc001.mcc001.3gppnetwork.org",
      realm: "epc.mnc001.mcc001.3gppnetwork.org",
      ip: "10.0.2.30",
      initiate_connection: true
    }
  ]
}
```

PCRF 配置

```
diameter: %{
  listen_ip: "0.0.0.0",
  host: "omnipgw.epc.mnc001.mcc001.3gppnetwork.org",
  realm: "epc.mnc001.mcc001.3gppnetwork.org",
  peer_list: [
    %{
      host: "pcrf.epc.mnc001.mcc001.3gppnetwork.org",
      realm: "epc.mnc001.mcc001.3gppnetwork.org",
      ip: "10.0.0.30",
      initiate_connection: false # PCRF 配置
    }
  ]
}
```

配置 Diameter Gx 配置

S5/S8

GTP-C SGW-C

```
config :pgw_c,  
  s5s8: %{  
    # S5/S8 IPv4  
    local_ipv4_address: "10.0.0.20",  
  
    # IPv6  
    local_ipv6_address: nil,  
  
    # GTP-C 2123  
    local_port: 2123,  
  
    # GTP-C 500  
    # GTP-C  
    request_timeout_ms: 500,  
  
    # GTP-C 3  
    # = request_timeout_ms * request_attempts  
    request_attempts: 3  
  }
```

□□

□□	□□	□□□	□□
<code>local_ipv4_address</code>	□□□□IPv4□	□□	S5/S8 □□□ IPv4 □□
<code>local_ipv6_address</code>	□□□□IPv6□	<code>nil</code>	S5/S8 □□□ IPv6 □□□□□□
<code>local_port</code>	□□	<code>2123</code>	GTP-C □ UDP □□□□□□□ 2123□
<code>request_timeout_ms</code>	□□	<code>500</code>	□□□□□□□□□□□□
<code>request_attempts</code>	□□	<code>3</code>	□□□□□□□□□□

□□□□

- □□□ GTP-C □□ 2
- □□□ UDP
- □□□□□ 2123
- □□□ □ SGW-C □□

□□

□ **IPv4**□□□□□

```
s5s8: %{\n  local_ipv4_address: "10.0.0.20"\n}
```

IPv4 + IPv6 □□□

```
s5s8: %{\n  local_ipv4_address: "10.0.0.20",\n  local_ipv6_address: "2001:db8::20"\n}
```

Wireshark

- Wireshark 安装与配置
- Wireshark 抓包与过滤
- Wireshark 分析网络流量

PCRF

- PCRF 与 Diameter 协议
- PCRF 与 Diameter 交互
- PCRF 与 Diameter 配置

IP

IP 地址

- IP 地址规划
- IP 地址分配
- IP 地址管理

IP 地址

```
# SGW-C 与 GTP-C  
iptables -A INPUT -p udp --dport 2123 -s <sgw_c_network> -j ACCEPT
```

Sxb/PFCP

配置

配置 PFCP 与 PGW-U 交互

```
sxb: %{
  local_ip_address: "10.0.0.20"
}

# [] upf_selection [] UPF []
# - []`"UPF-10.0.0.21:8805"`
# - [] PCFP [] UPF []
# - 5 []
```

[] **PCFP** []

```
sxb: %{
  local_ip_address: "10.0.0.20",
  local_port: 8806 # [] PCFP []
}
```

[] **UPF** []

```

sxb: %{
  local_ip_address: "10.0.0.20"
},
upf_selection: %{
  rules: [
    %{
      name: "IMS ",
      priority: 10,
      match_field: :apn,
      match_regex: ~r/^ims$/,
      upf_pool: [
        %{remote_ip_address: "10.0.1.21", remote_port: 8805,
weight: 100},
        %{remote_ip_address: "10.0.1.22", remote_port: 8805,
weight: 100}
      ]
    }
  ],
  fallback_pool: [
    %{remote_ip_address: "10.0.2.21", remote_port: 8805, weight:
100}
  ]
}
# 3 UPF 10.0.1.21 10.0.1.22 10.0.2.21

```

DNS

```

sxb: %{
  local_ip_address: "10.0.0.20"
},
upf_selection: %{
  dns_enabled: true,
  dns_query_priority: [:ecgi, :tai],
  dns_suffix: "epc.3gppnetwork.org",
  fallback_pool: [
    %{remote_ip_address: "10.0.2.21", remote_port: 8805, weight:
100}
  ]
}
# DNS UPF

```

UPF 部署

UPF 部署时，UPF 部署 `upf_selection` 部署

部署

UPF 部署 `upf_selection` 部署

1. 部署 - 部署
2. **DNS** 部署 - 部署 UPF 部署
3. 部署 - 部署 DNS 部署

部署

1. 部署 - 部署
2. 部署 **DNS** 部署 - 部署 UPF 部署
3. 部署 - 部署 DNS 部署

UPF 部署

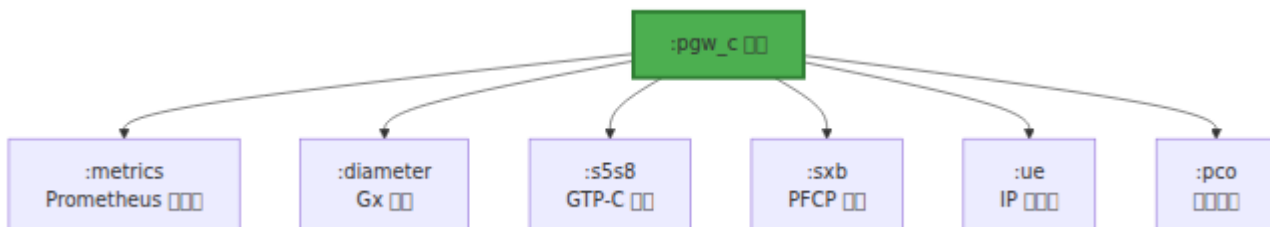

部署

部署

項目	説明	正規表現
:imsi	IMSI	^313380.*  00
:apn	APN / DNN	^internet\. ^ims\.
:serving_network_plmn_id	PLMN ID	^313380\$
:sgw_ip_address	SGW IP	^10\.100\.\.*
:uli_tai_plmn_id	ULI TAI PLMN ID	^313.*
:uli_ecgi_plmn_id	E-UTRAN ULI PLMN ID	^313.*

設定項目

項目	説明	値	単位
UPF	UPF	IPアドレス	UPF
APN	APN	IMS/インターネット	
IMSI	IMSI		
DNS	MEC/DNS	IPアドレス	DNS
		UPF	

□□□□□□□□

□□□□□□□□□□□□□□□□□□ UPF □□□ PCO □□□

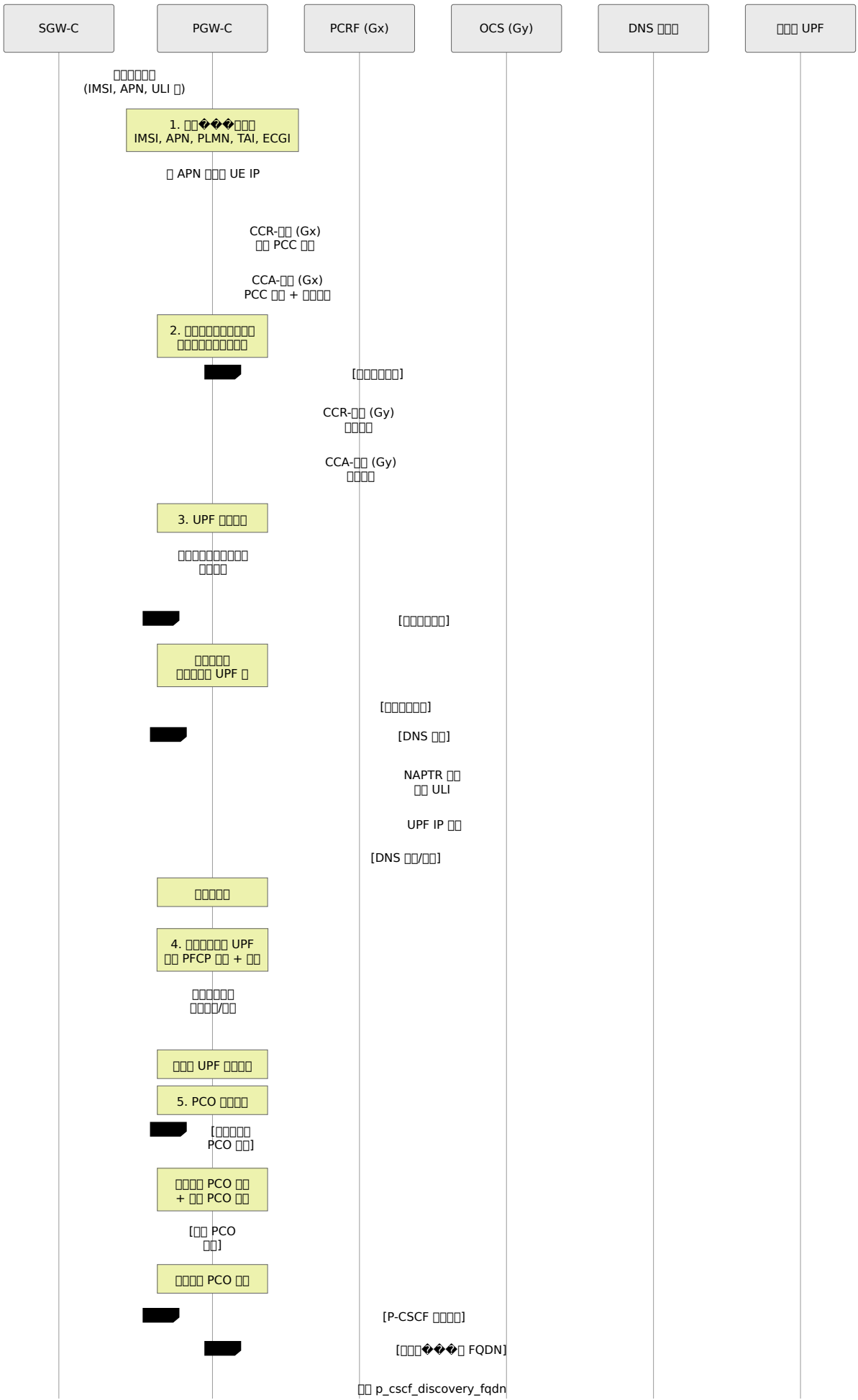

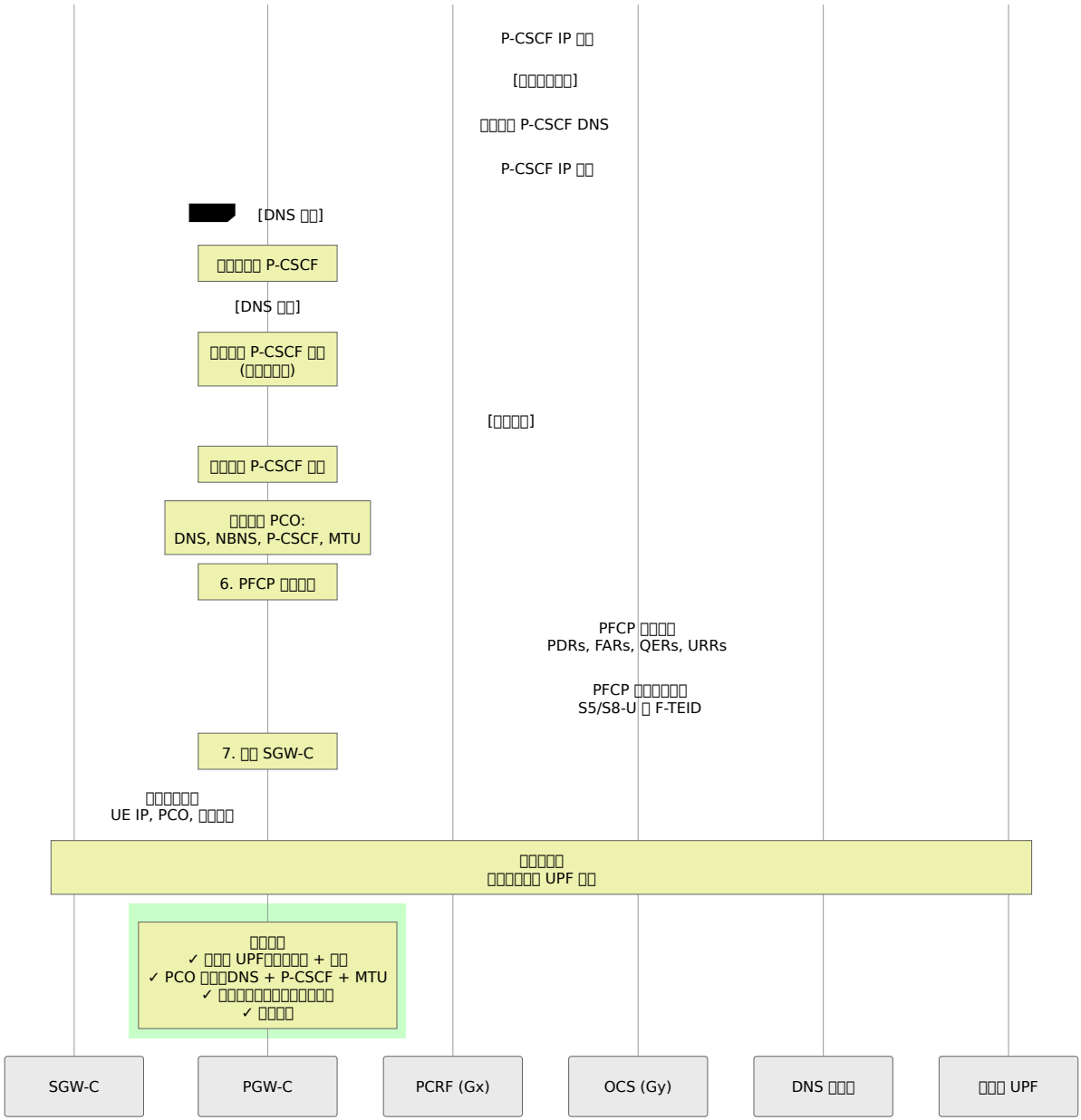

□□□□□□

1. UPF □□□□□□

- □□□□□□□□□□ → DNS □□ → □□□
- □□□□□□□□□□□□
- □□/□□□□□□□□□□□□
- □□ PFCP □□ □□□ UPF □□□□□□□□

2. PCO □□□□□□

- □□ PCO □□ → P-CSCF DNS □□ → □□ PCO □□
- □□□□□□□□□□□□□□□□□□□□□□□□□□

- 网络 PCO 网络 网络 PCO 网络

3. P-CSCF 网络

- 网络 FQDN → 网络 DNS 网络 → 网络 PCO → 网络 PCO
- 网络 P-CSCF 网络 网络

4. 网络

- PCRF 网络 + 网络=1网络
- OCS 网络
- PGW-C 网络 CCR-网络
- 网络 Diameter Gx 网络 网络 Diameter Gy 网络 网络

网络

网络 UPF 网络

```

config :pgw_c,
  # PFCP [] - [] UPF [] upf_selection []
  sxb: %{
    local_ip_address: "127.0.0.20"
  },

  # UPF [] - [] UPF []
  upf_selection: %{
    # [] DNS []
    dns_enabled: false,
    dns_query_priority: [:ecgi, :tai, :rai, :sai, :cgi],
    dns_suffix: "epc.3gppnetwork.org",
    dns_timeout_ms: 5000,

    # []
    rules: [
      # [] 1[]IMS [] - []
      %{
        name: "IMS []",
        priority: 20,
        match_field: :apn,
        match_regex: "^ims",
        upf_pool: [
          weight: 80,
          %{remote_ip_address: "10.100.2.21", remote_port: 8805,
          weight: 20}
          %{remote_ip_address: "10.100.2.22", remote_port: 8805,
          weight: 20}
        ]
      },

      # [] 2[] APN
      %{
        name: "[]",
        priority: 15,
        match_field: :apn,
        match_regex: "^(enterprise|corporate)\.apn",
        upf_pool: [
          weight: 100,
          %{remote_ip_address: "10.100.3.21", remote_port: 8805,
          weight: 100}
        ]
      },

      # [] 3[] - []

```

```

    %{
      name: "互联网",
      priority: 5,
      match_field: :apn,
      match_regex: "^internet",
      upf_pool: [
        %{remote_ip_address: "10.100.1.21", remote_port: 8805,
weight: 33},
        %{remote_ip_address: "10.100.1.22", remote_port: 8805,
weight: 33},
        %{remote_ip_address: "10.100.1.23", remote_port: 8805,
weight: 34}
      ]
    }
  ],

  # 本地 - 本地 DNS 服务器
  fallback_pool: [
    %{remote_ip_address: "127.0.0.21", remote_port: 8805,
weight: 100}
  ]
}

```

互联网

本地

- 本地 DNS 服务器 `upf_selection` 本地 UPF 服务器
- 本地 DNS 服务器 UPF 服务器
- 本地 DNS 服务器 `upf_pool` 本地 UPF 服务器
- 本地 DNS 服务器 `fallback_pool` 本地 DNS 服务器
- 本地 DNS 服务器 DNS 服务器
- 本地 DNS 服务器 DNS 服务器 UPF 服务器
- 本地 DNS 服务器 UPF 服务器 5 本地 DNS 服务器

本地 DNS 服务器

- 本地 `sxb.peer_list` 本地 DNS 服务器
- 本地 DNS 服务器 `selection_list`

- 每個 UPF 都有一個 `upf_selection` 的參數

UPF 的運作

1. 每個 UPF 的運作

- 每個 = PFCP 的參數 + 每個 3 個參數
- 每個 UPF 的運作
- 每個 UPF 的運作 UPF 的運作

2. 每個/每個的 `weight: 0` 的 UPF

- 每個 **UPF** 的 `weight > 0`
- 每個 **UPF** 的 `weight == 0` 的 UPF 的運作
- 每個 UPF 的 `weight: 1`

3. 每個 UPF 的運作

- 每個 70% 的參數 .21 20% 的參數 .22 10% 的參數 .23
- 每個 = 每個 UPF
- 每個 = 每個

4. 每個 UPF 的運作

- 每個的 `"UPF-<ip>:<port>"`
- 每個 PFCP 的參數 5 個
- 每個 UPF 的運作

□□□□□□□□/□□

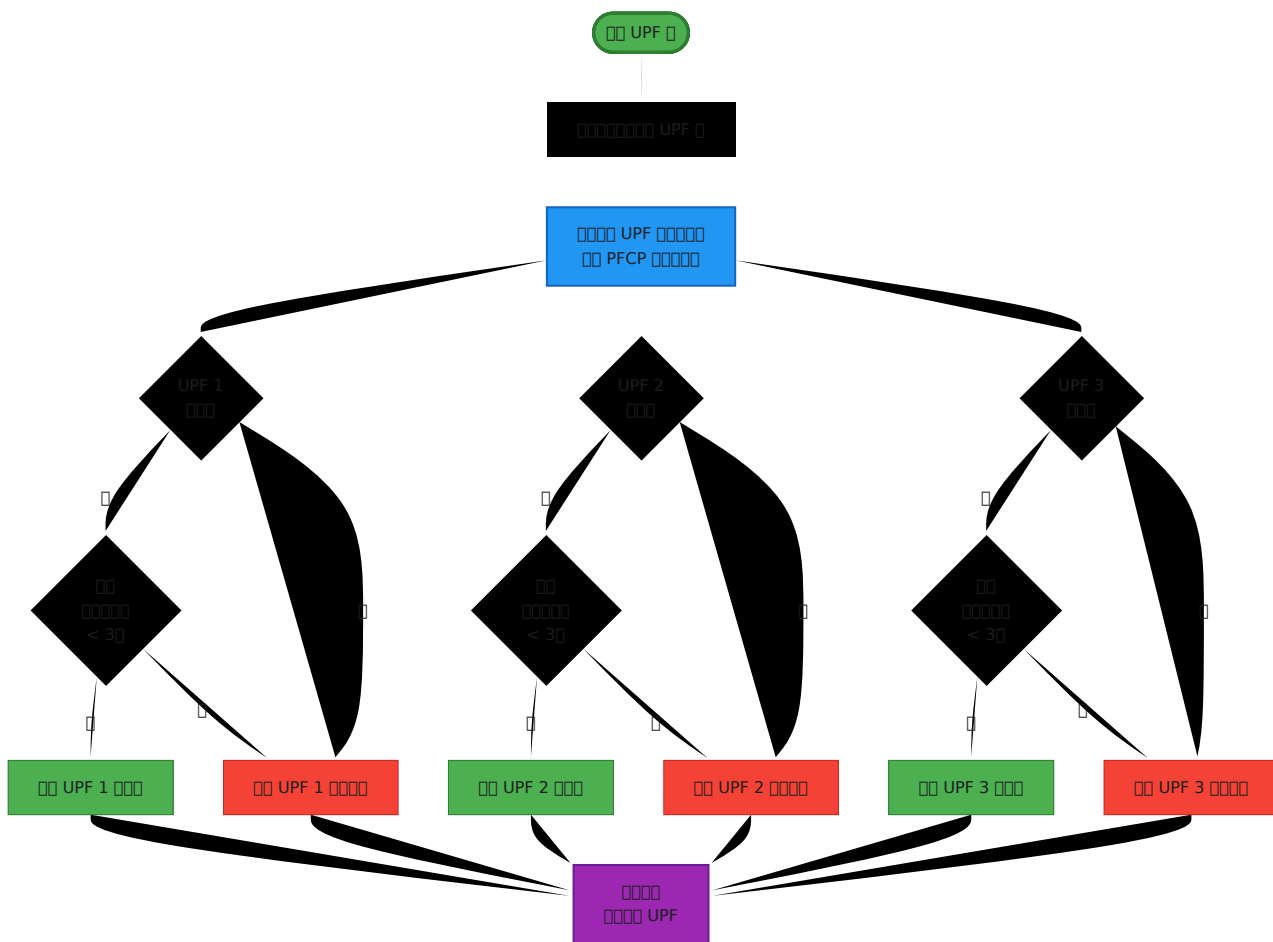

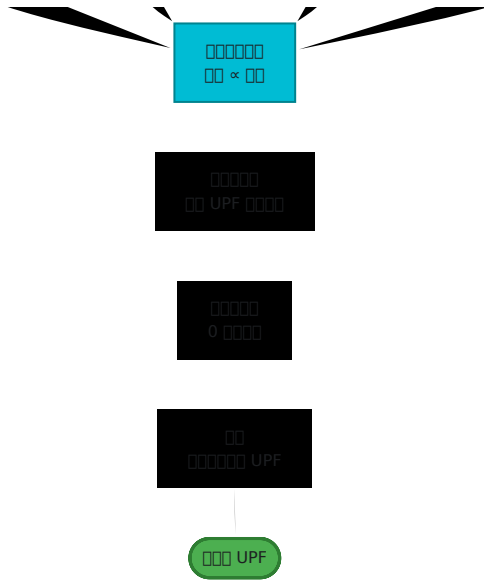

0000000000

0: [
 UPF-A: 00 50, 00 ✓
 UPF-B: 00 30, 00 ✓
 UPF-C: 00 20, 00 ✓
]

000: 50 + 30 + 20 = 100

0000:
 UPF-A: 0-49 (50%)
 UPF-B: 50-79 (30%)
 UPF-C: 80-99 (20%)

000: 63 → 00 UPF-B
 000: 15 → 00 UPF-A
 000: 91 → 00 UPF-C

00/0000000000

```
UPF: [  
  UPF-A: 100, 1 ✓ (1)  
  UPF-B: 0, 1 ✓ (1)  
]
```

```
UPF 1: UPF-A 100  
→ UPF: [UPF-A: 100]  
→ UPF-A
```

```
UPF 2: UPF-A 1  
→ UPF  
→ UPF: [UPF-B: 1]  
→ UPF-B  
→ UPF: "UPF UPF"
```

```
UPF 3: UPF-A 100, UPF-B 0  
→ UPF  
→ UPF: [UPF-A: 100, UPF-B: 0]  
→ UPF  
→ UPF: "UPF UPF"
```

UPF

```

# 25%
upf_pool: [
  %{remote_ip_address: "10.0.1.1", remote_port: 8805, weight: 1},
  %{remote_ip_address: "10.0.1.2", remote_port: 8805, weight: 1},
  %{remote_ip_address: "10.0.1.3", remote_port: 8805, weight: 1},
  %{remote_ip_address: "10.0.1.4", remote_port: 8805, weight: 1}
]

# 90% / 10%
upf_pool: [
  %{remote_ip_address: "10.0.1.21", remote_port: 8805, weight:
90},
  %{remote_ip_address: "10.0.1.22", remote_port: 8805, weight: 10}
]

# 100% 0%
upf_pool: [
  %{remote_ip_address: "10.0.1.21", remote_port: 8805, weight:
100}, #
  %{remote_ip_address: "10.0.1.22", remote_port: 8805, weight: 0}
#
]

#
upf_pool: [
  %{remote_ip_address: "10.0.1.1", remote_port: 8805, weight:
100}, #
  %{remote_ip_address: "10.0.1.2", remote_port: 8805, weight: 0},
# 1
  %{remote_ip_address: "10.0.1.3", remote_port: 8805, weight: 0}
# 2
]
# 100% 50/50%

# A/B 50% / 50%
upf_pool: [
  %{remote_ip_address: "10.0.1.100", remote_port: 8805, weight:
50}, #
  %{remote_ip_address: "10.0.1.200", remote_port: 8805, weight:
50} #
]

```

PCO □□□□□□

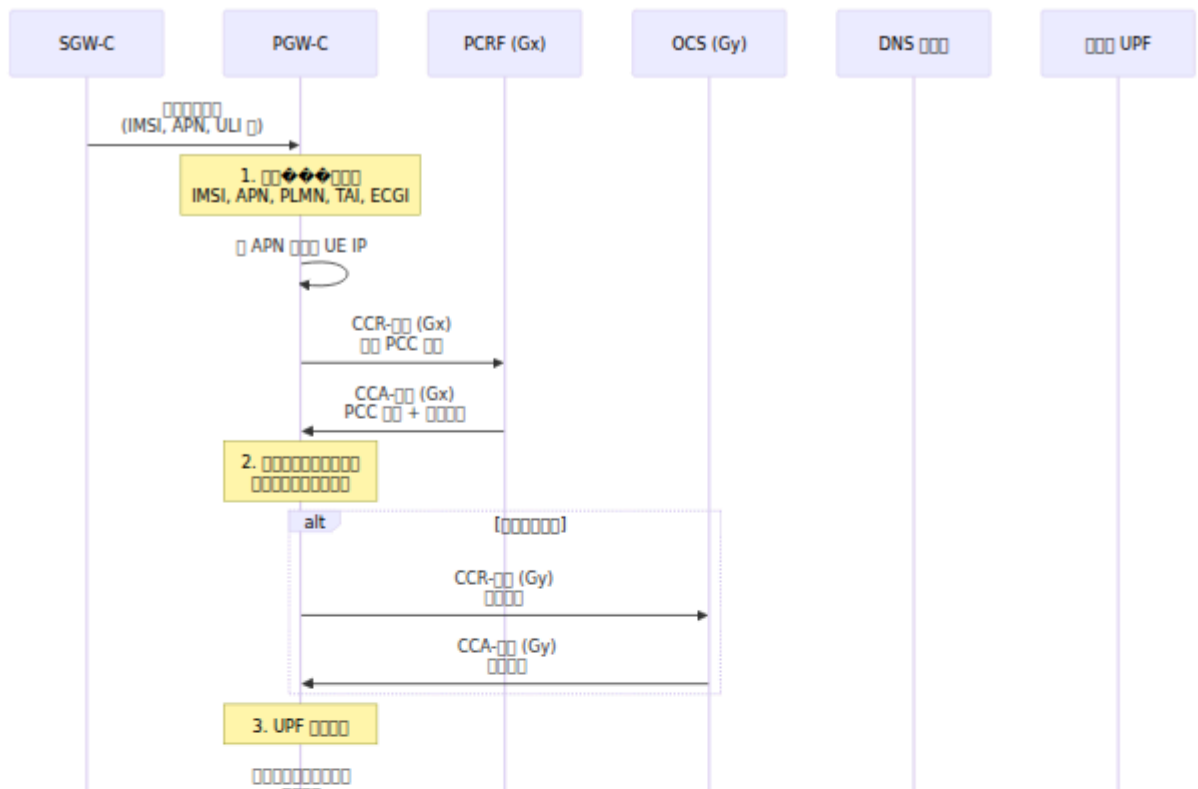

OmniCharge

OmniRAN

Downloads

🔍 [Search Icon]

OmniTouch Website [↗](#)

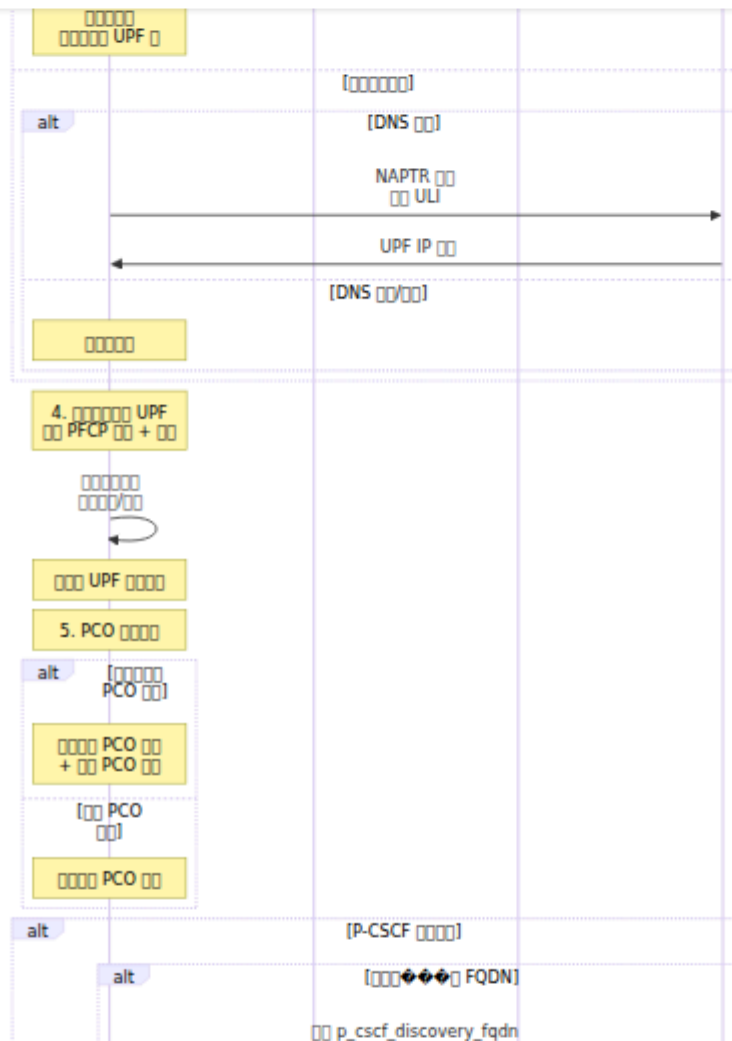

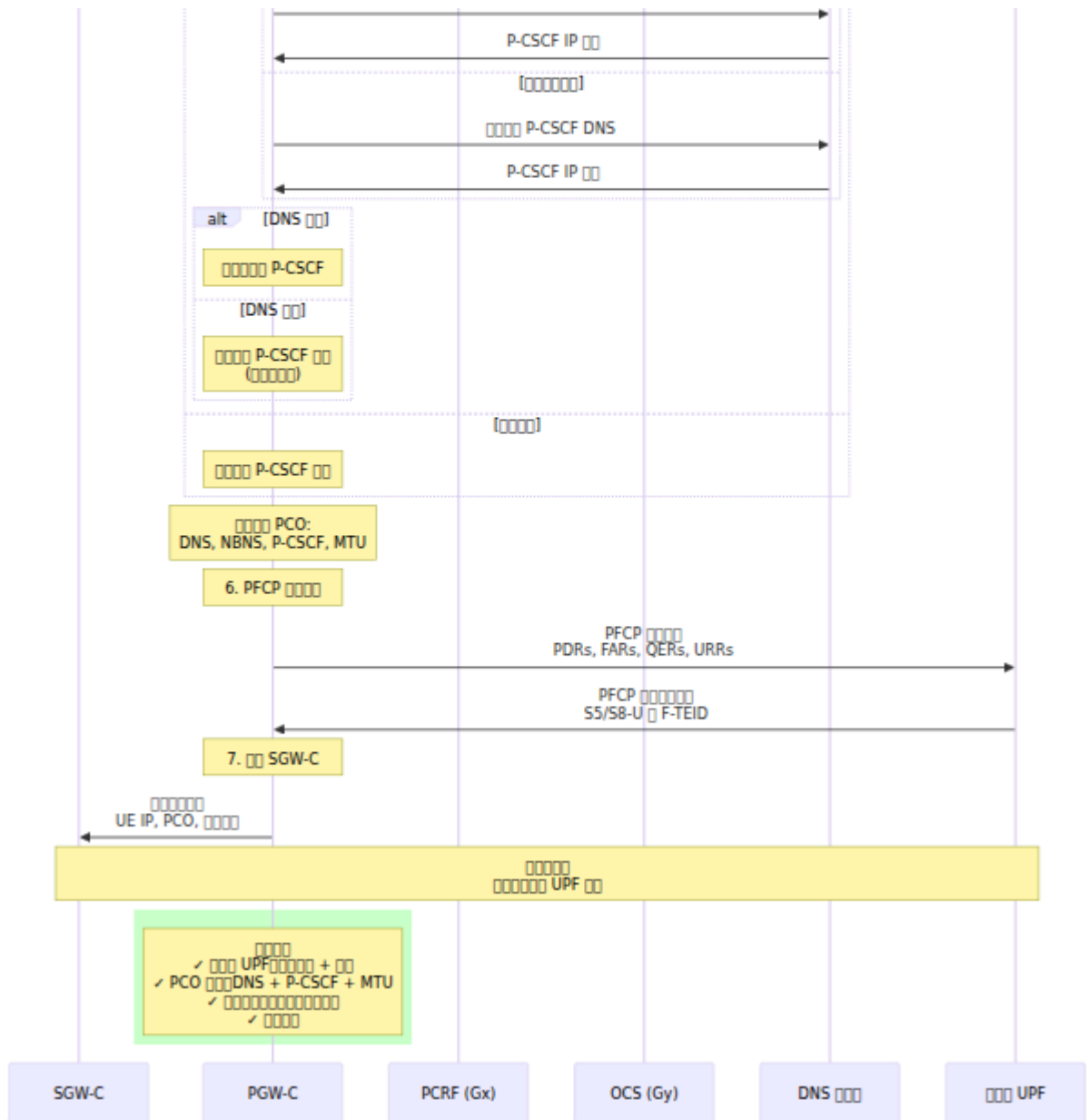

PCO

1. **PCO**
2. **P-CSCF DNS**
3. **PCO** /

IMS DNS

```
IMS 配置 "IMS 配置" 配置
├─ DNS 配置
├─ P-CSCF 配置 DNS 配置 p_cscf_discovery_fqdn 配置
│   └─ DNS 配置
└─ MTU 配置
```

```
配置 "配置" 配置
├─ DNS 配置 192.168.1.10, 192.168.1.11
├─ P-CSCF 配置
└─ MTU 配置 1500
```

```
配置
├─ DNS 配置
├─ P-CSCF 配置 DNS 配置
└─ MTU 配置
```

配置 PCO 配置

- `primary_dns_server_address` - DNS 配置 IP
- `secondary_dns_server_address` - DNS 配置 IP
- `primary_nbns_server_address` - WINS 配置 IP
- `secondary_nbns_server_address` - WINS 配置 IP
- `p_cscf_ipv4_address_list` - P-CSCF 配置 IP 配置 IMS - 配置 PCO 配置 P-CSCF 配置
- `ipv4_link_mtu_size` - MTU 配置

配置 P-CSCF 配置

PCO UPF P-CSCF

- `p_cscf_discovery_fqdn` - DNS P-CSCF FQDN
`"pcscf.mnc380.mcc313.3gppnetwork.org"`

- PGW-C FQDN DNS
- DNS P-CSCF IP
- P-CSCF PCO UE
- DNS PCO `p_cscf_ipv4_address_list` PCO
- P-CSCF /

- IMS APN** - IMS P-CSCF
- P-CSCF
- DNS UE P-CSCF
- DNS P-CSCF

P-CSCF **IMS**

```

rules: [
  %{
    name: "IMS []",
    priority: 20,
    match_field: :apn,
    match_regex: "^ims",
    upf_pool: [
      %{remote_ip_address: "10.100.2.21", remote_port: 8805,
weight: 80},
      %{remote_ip_address: "10.100.2.22", remote_port: 8805,
weight: 20}
    ],
    # P-CSCF [] DNS [] P-CSCF []
    # DNS [] FQDN [] P-CSCF IP
    p_cscf_discovery_fqdn: "pcscf.mnc380.mcc313.3gppnetwork.org",
    # IMS [] P-CSCF [] DNS []
    pco: %{
      p_cscf_ipv4_address_list: ["10.101.2.100", "10.101.2.101"]
      # DNS, NBNS, MTU [] pco []
    }
  }
]

```

[][][] **DNS** []

```

rules: [
  %{
    name: "PCO",
    priority: 15,
    match_field: :apn,
    match_regex: "^(enterprise|corporate)\.apn",
    upf_pool: [
      %{remote_ip_address: "10.100.3.21", remote_port: 8805,
weight: 100}
    ],
    # PCO DNS MTU
    pco: %{
      primary_dns_server_address: "192.168.1.10",
      secondary_dns_server_address: "192.168.1.11",
      ipv4_link_mtu_size: 1500
      # P-CSCF, NBNS PCO
    }
  }
]

```

PCO

```

rules: [
  %{
    name: "IoT APN - IoT",
    priority: 10,
    match_field: :apn,
    match_regex: "^iot\\.m2m",
    upf_pool: [
      %{remote_ip_address: "10.100.5.21", remote_port: 8805,
weight: 100}
    ],
    # IoT PCO
    pco: %{
      primary_dns_server_address: "8.8.8.8",
      secondary_dns_server_address: "8.8.4.4",
      primary_nbns_server_address: "10.0.0.100",
      secondary_nbns_server_address: "10.0.0.101",
      p_cscf_ipv4_address_list: [], # IoT P-CSCF
      ipv4_link_mtu_size: 1280 # MTU
    }
  }
]

```

•

- **IMS/VoLTE** P-CSCF
- **APN** DNS
- **IoT/M2M** DNS MTU
- DNS
-

• **DNS** **UPF**

ULI UPF DNS NAPTR DNS `upf_selection`

UPF PFCP UPF PFCP

```
upf_selection: %{
  # DNS
  dns_enabled: true,

  #
  dns_query_priority: [:ecgi, :tai, :rai, :sai, :cgi],

  # 3GPP NAPTR DNS
  dns_suffix: "epc.3gppnetwork.org",

  # DNS
  dns_timeout_ms: 5000,

  # ...
}
```

DNS

1. DNS
2. UE DNS NAPTR
 - ECGI `eci-<hex>.ecgi.epc.mnc<MNC>.mcc<MCC>.epc.3gppnetwork.org`
 - TAI `tac-lb<hex>.tac-hb<hex>.tac.epc.mnc<MNC>.mcc<MCC>.epc.3gppnetwork.org`
 - RAI/SAI/CGI 3GPP TS 23.003
- 3.
4. DNS
- 5.

DNS DNS

```
; NAPTR PLMN 313-380 TAC 100
tac-lb64.tac-hb00.tac.epc.mnc380.mcc313.epc.3gppnetwork.org IN
NAPTR 10 50 "a" "x-3gpp-upf:x-sxb" "" upf-edge-1.example.com.

; UPF A
upf-edge-1.example.com IN A 10.100.1.21
```

- 0000000000
- 0000000000

0000

00/00000000 weight: 0 000

1. 00000000 UPF
2. 0000 00000 > 000 00000 == 00
3. 0000000000 UPF00000000 UPF
4. 00000000 UPF 0000000000 UPF000000 10
5. 00000000 UPF0000000000

000000000000 > 000

1. 00000000 UPF
2. 0000 UPF 0000000000
3. 00000000 UPF0000000000

000000

```
[debug] 0000 UPF 002/3 00 UPF01 000
[info] 0000 UPF 00000000 UPF01 00 UPF0000 0 00 10
[warning] 00000000 UPF000 3 00000000000000
```

00 **UPF** 00

000000

```

# 確認 UPF 状態
iex> PGW_C.PFCP_Node.is_peer_healthy?({10, 100, 1, 21})
true

# 詳細状態を確認
iex> PGW_C.PFCP_Node.get_peer_health({10, 100, 1, 21})
%{
  associated: true,
  missed_heartbeats: 0,
  healthy: true,
  registered: true
}

```

Web UI

- 確認 URL `/upf_selection`
- 確認 UPF 状態
- 確認 UP-UP 状態
- 確認 `> 0` 状態 == `0` 状態 DNS 状態
- 確認 UPF 状態

確認

1. `upf_selection` 確認 **UPF** 状態 UPF 状態

```

upf_selection: %{
  rules: [
    %{
      name: "internet",
      priority: 10,
      match_field: :apn,
      match_regex: "^internet",
      upf_pool: [
        %{remote_ip_address: "10.100.1.21", remote_port: 8805,
weight: 100}
      ]
    }
  ],
  fallback_pool: [
    %{remote_ip_address: "10.100.2.21", remote_port: 8805,
weight: 100}
  ]
}
# UPF
# - 5
# -
# -

```

2. **UPF** `weight: 0` `weight: 0`

```

upf_pool: [
  %{remote_ip_address: "10.1.1.1", remote_port: 8805, weight:
100}, #
  %{remote_ip_address: "10.1.1.2", remote_port: 8805, weight:
0} #
]

```

3. **Web UI** `UPF`

4. `3`

UPF

PGW-C DNS UPF `upf_selection`

- □□□□□□□□□ DNS □ UPF □□□□□□□□□□□□
- □□□□□□□□□□□□□□ PGW-C □□□□□ UPF □□□□□
- □□□□□□□□□□□□□□□□□□□□□□□□□□□□
- □□□□□□□□□ UPF □□□□□□□
- □□□□□□□□ UPF □□□□□□□□□□□□□□□□



□□□□

□□□□□□□ UPF □□□□ PFCP □□□□□

```
[error] □□ UPF {10, 200, 5, 99} □ PFCP □□□□□□□□□□
[error] □□□□ UPF {10, 200, 5, 99} □□□□□□□□
□□□□□□□□□□□□□□ UPF □□□ upf_selection □□□□
```

□□□□□□□□□□ PGW-C □□□□□□□□□□□□□□□□

□□□□□□□□□□

□□	□□
□□□□ UPF	□ upf_selection □□□□□□□□□□□□□□□□
DNS □□□□□ UPF	□□□□□□□□□□□□□□□□
□□/□□ UPF	□□□□□□□□□□□□□□
□□□□ UPF	□ upf_selection □□□□□□□□□□   □□□□
□□/□□□□□ UPF	□□□□□□□□□□ UPF □□□□□□□□□□

□□□□ **UPF**

□□ UPF □□□□□□□□□□□□□□□□

```
[info] □□□ PFCP □□□□□□□□□□-UPF-10-200-5-99 ({10, 200, 5, 99}:8805)
[info] □□ UPF □□□□□□□□□□-UPF-10-200-5-99 □□□□□□PID #PID<0.1234.0>
```

□□□□□□□□□□□□□□□□□□□□□□□□□□□□□□□□

```
# □□□□□□□□□□  
PGW_C.PFCP_Node.registered_peer_count()  
  
# □□□□ UPF □□□□  
PGW_C.PFCP_Node.get_peer({10, 200, 5, 99})  
# □□□{:ok, #PID<0.1234.0>} □□□□□□□□□□ :error
```

□□ **UPF** □□□□□□

□□□□ UPF □□□□□□ PFCP □□□□□□□□□□□□□□

```
# □□□□□□□□□□ UPF  
PGW_C.PFCP_Node.register_dynamic_peer({10, 200, 5,
```

PGW-C CDR (CDR) 說明

PGW-C 說明

OmniPGW 及 Omnitouch 說明

目錄

1. 說明
 2. CDR 說明
 3. CDR 說明
 4. CDR 說明
 5. 說明
 6. 說明
 7. CDR 說明
 8. 說明
 9. 說明
 10. 說明
-

說明

PGW-C CDR 說明 PGW-C CDR 說明

SGW-C CDR 說明 EPC 說明

說明

- CSV 說明 - 說明
- 說明 - 說明
- 說明 - 說明

- 3GPP - 3GPP TS 32.251 PS TS 32.298 CDR
- 3GPP - 3GPP TS 32.251 PS TS 32.298 CDR

CDR

Field	Description
CDR	CDR
CDR	CDR
CDR	CDR
CDR	CDR
CDR	CDR
CDR	CDR

CDR

CDR

```
<epoch_timestamp>
```

CDR

```
1726598022
```

CDR Unix

CDR

CDR

- PGW-C: `/var/log/pgw_c/cdrs/`

`cdr_directory` `config/runtime.exs`

CDR

```
# CDR  
# HH:MM:SS (unix_timestamp)  
# HH:MM:SS (unix_timestamp)  
# <gateway_name>  
#  
epoch,imsi,event,charging_id,msisdn,ue_imei,timezone_raw,plmn,tac,eci
```

- CDR Unix
 - Unix
 - PGW-C `pgw_name`
 - CSV
-

CDR 表

表名

列名	データ型	長さ	説明
0	epoch	整数	UNIX 時刻
1	imsi	文字列	IMSI
2	event	文字列	CDR イベント名 "default_bearer_start"
3	charging_id	整数	充電 ID
4	msisdn	文字列	MSISDN ISDN 番号
5	ue_imei	文字列	UE IMEI
6	timezone_raw	文字列	UE 時刻領域
7	plmn	文字列	PLMN
8	tac	文字列	TAC
9	eci	文字列	E-UTRAN セル ID
10	sgw_ip	文字列	SGW-C S5/S8 インターフェイス IP
11	ue_ip	文字列	UE IP アドレス IPv4/IPv6
12	pgw_ip	文字列	PGW-C S5/S8 インターフェイス IP
13	apn	文字列	アクセスポイント名
14	qci	整数	QoS プロファイル ID

OID	Object Name	Object Class	Object Value
15	octets_in	INTEGER	0000000000
16	octets_out	INTEGER	0000000000

CDR Objects

Objects

CDR Objects

Object Name	Object Class	Object Value	Object Value
default_bearer_start	INTEGER	0000	00000000
default_bearer_update	INTEGER	0000000000	00000000000000
default_bearer_end	INTEGER	0000	000000/00

Objects

- default - 00000000 PDN 000000
- dedicated - 00000000 PDN 00000000

Objects

```

default_bearer_start      - 00000000
default_bearer_update    - 0000000000
default_bearer_end       - 00000000
dedicated_bearer_start   - 00000000
dedicated_bearer_update - 0000000000
dedicated_bearer_end     - 00000000

```

□□□□

□□ **CDR** □□

```
# □□ CDR □□  
# □□□□□□18:53:42 (1726598022)  
# □□□□□□19:53:42 (1726601622)  
# □□□□sgw-c-prod-01  
# epoch,imsi,event,charging_id,msisdn,ue_imei,timezone_raw,plmn,tac,e  
1726598022,310260123456789,default_bearer_start,12345,15551234567,123  
1726598322,310260123456789,default_bearer_update,12345,15551234567,12  
1726598622,310260123456789,default_bearer_update,12345,15551234567,12  
1726598922,310260123456789,default_bearer_end,12345,15551234567,12345
```

□□□□

CDR □□□□□□□□□□□□□□□□

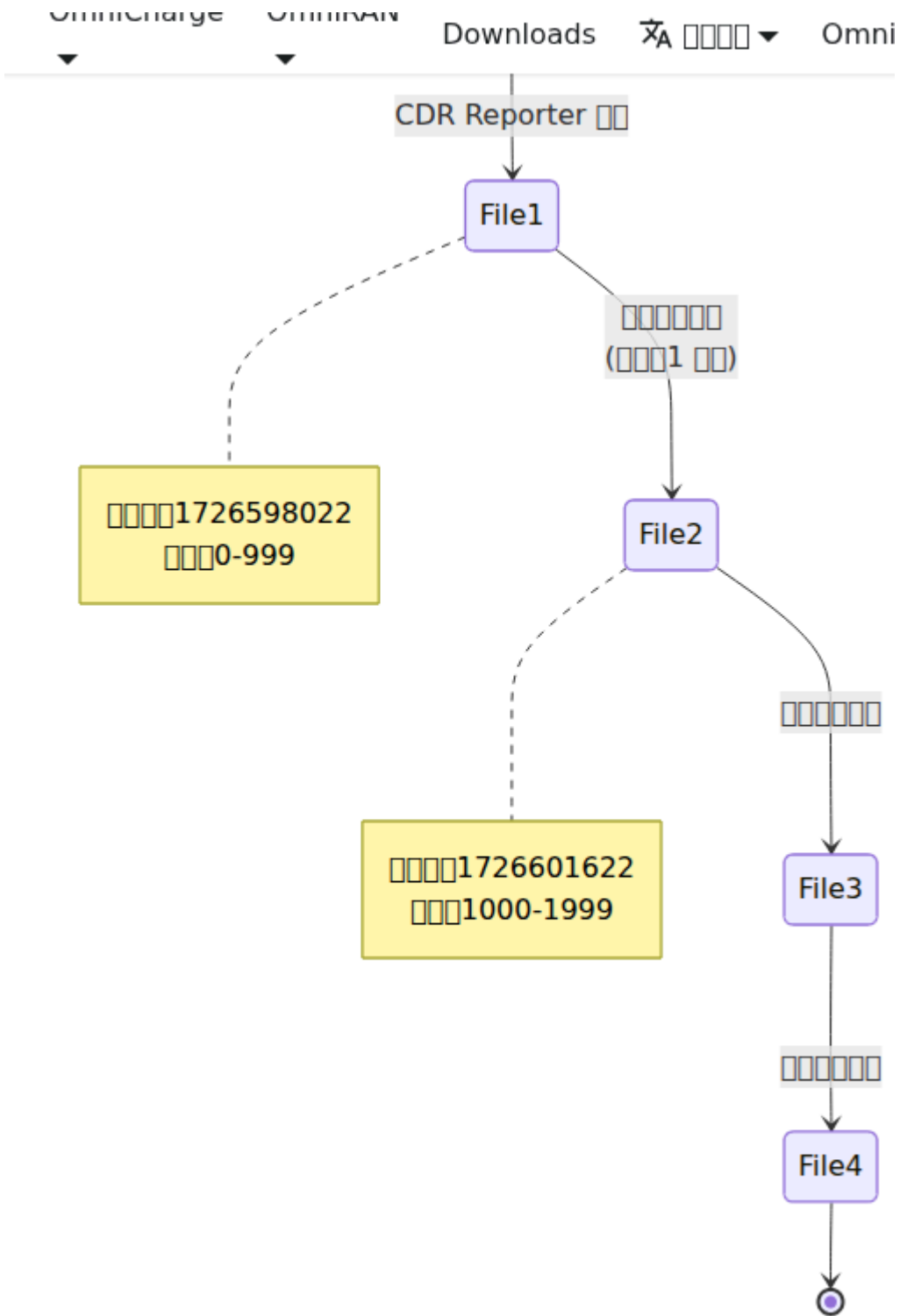

000000

1. 0000 CDR 00
2. 0000000000000000
3. 00000000
4. 000 CDR 000000

□□

□□□□

PGW-C CDR □□□ `config/runtime.exs` □□□□

□□	□ □	□□	□□□	□□□
<code>pgw_name</code>	□ □ □	PGW □□□□ □□□□ □ CDR □□□	"omni- pgw01"	◆◆◆□□□□□□□ ID
<code>cdr_file_duration</code>	□ □	□□□□ □□□□ □□	3600000	3600000□1 □□□
<code>cdr_directory</code>	□ □ □	CDR □□□□ □□	"/tmp/pgw_c"	<code>/var/log/pgw_c/cdrs</code>
<code>usage_report_interval</code>	□ □	URR □□□□ □□□□ - PGW- U □□ □□□□ □□□	60000	60000□1 □□□

□□□□

□□□□ (**config/runtime.exs**):

```

config :pgw_c,
  # CDR
  pgw_name: "omni-pgw01",
  cdr_file_duration: 3_600_000,           # 1
  cdr_directory: "/var/log/pgw_c/cdrs",

  # URR PGW-U
  usage_report_interval: 60_000          # 60

```

PGW-C:

```

config :pgw_c,
  pgw_name: "pgw-c-prod-01",
  cdr_file_duration: 3_600_000,           # 1
  cdr_directory: "/var/log/pgw_c/cdrs",
  usage_report_interval: 60_000          # 1

```

PGW-C:

```

config :pgw_c,
  pgw_name: "pgw-c-dev",
  cdr_file_duration: 300_000,             # 5
  cdr_directory: "/tmp/pgw_c_cdrs",
  usage_report_interval: 30_000          # 30

```

PGW-C:

```

config :pgw_c,
  pgw_name: "pgw-c-prod-heavy",
  cdr_file_duration: 1_800_000,           # 30
  cdr_directory: "/mnt/fast-storage/cdrs",
  usage_report_interval: 300_000          # 5

```

URR

PGW-C **PFCP URRs** PGW-U URR PGW-U CDR

URR

1. `usage_report_interval` PFCP
2. PGW-C URR
3. PGW-U
4. `bearer_update` CDR
5. `bearer_end` CDR

`usage_report_interval: 60_000`

- PGW-U 60
- 60 CDR
-

URR

```
# lib/core/session/types.ex
defmodule PGW_C.Session.Types.URR do
  typedstruct do
    field :urr_id, non_neg_integer()
    field :measurement_method, :duration | nil
    field :reporting_triggers, :time_threshold | nil
    field :time_threshold, non_neg_integer() | nil #
  end
end
```

PFCP URR PFCP lib/core/session/impl/procedures.ex:468
URR

CDR

CDR

PGW-C CDR

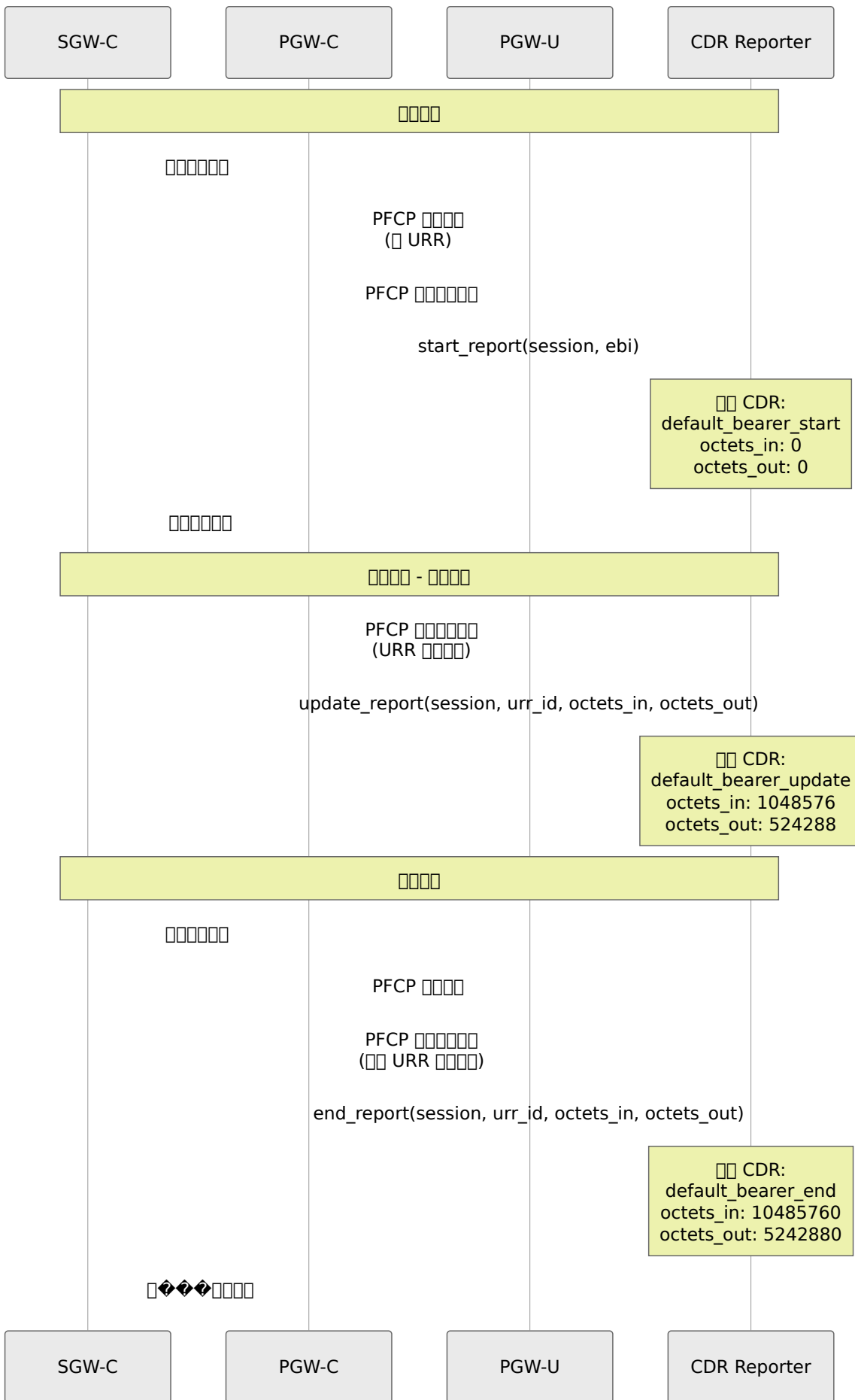

CDR 0000

1. 0000

- 000 0000000000
- 000 000000000000
- **octets_in** 0
- **octets_out** 0

2. 0000

- 000 0 PGW-U 00 PFCP 00000000URR 00000
- 000 0000000000
- **octets_in** 0000000000000000
- **octets_out** 0000000000000000
- 000 URR 0000000000 `usage_report_interval` 000

3. 0000

- 000 0 PGW-U 00 PFCP 000000000000000000
- 000 0000000000000000
- **octets_in** 00000000
- **octets_out** 00000000

00000000

1. epoch00000

000 Unix 0000000000

000 CDR 00000000

000

1726598022 → 2025-09-17 18:53:42 UTC

2. imsi

15

MCCMNC + MSIN

310260123456789

└─┘ └─┘ └──────────┘

MCC MNC MSIN

(310) (260) (123456789)

UE

3. event CDR

<bearer_type>_bearer_<event>

- default_bearer_start
- default_bearer_update
- default_bearer_end
- dedicated_bearer_start
- dedicated_bearer_update
- dedicated_bearer_end

- EBI EPS ID LBI ID default
- EBI LBI dedicated

EBI LBI

4. charging_id

32

12345

PGW-C

- SGW PGW
- Gy/Gz
-

5. msisdn

E.164

ISDN

+

15551234567



CC

(1) (5551234567)

UE MME HSS

6. ue_imei

IMEI 15

TAC 8 + SNR 6 + Spare 1

IMEI

IMEI

123456789012345



TAC

SNR S

UE MME

7. timezone_raw UE

timezone

UE

CSV

timezone

UE

, ()

8. plmn

MCC: 505, MNC: 57

↓

"50557"

↓

"055570"

↓

0x055570 = 349552

349552 → MCC: 505, MNC: 57

MME UE

9. tac

16

UE

0 - 65535

1234

UE MME

-
-
- TAI

10. eci E-UTRAN

28

E-UTRAN UE

eNodeB ID 20 + ID 8

0 - 268,435,455

5678

MME UE

-
-
-

11. sgw_ip SGW IP

IPv4 IPv6

SGW-C S5/S8 IP F-TEID

IPv4 IPv6

10.0.0.15 (IPv4)
2001:db8::15 (IPv6)

S5/S8

12. ue_ip UE IP

IPv4|IPv6

UE IP PDN

<ipv4>|<ipv6>

172.16.1.100| (IPv4)
|2001:db8::1 (IPv6)
172.16.1.100|2001:db8::1 ()

PGW-C PDN PAA

- IPv4 IPv4
- IPv6 IPv6
- PDN

13. pgw_ip PGW IP

IPv4 IPv6

PGW-C S5/S8 IP F-TEID

IPv4 IPv6

```
10.0.0.20      (IPv4)
2001:db8::20   (IPv6)
```

PGW-C

14. apn

100

PDN

DNS

```
internet
ims
mms
enterprise.corporate
```

MME

- -
 - IP
-

15. qci QoS

8

QoS

1 - 9 128-254

QCI

QCI					
1	GBR	2	100 ms	10^{-2}	
2	GBR	4	150 ms	10^{-3}	
3	GBR	3	50 ms	10^{-3}	
4	GBR	5	300 ms	10^{-6}	
5	Non-GBR	1	100 ms	10^{-6}	IMS
6	Non-GBR	6	300 ms	10^{-6}	
7	Non-GBR	7	100 ms	10^{-3}	
8	Non-GBR	8	300 ms	10^{-6}	
9	Non-GBR	9	300 ms	10^{-6}	

9 →

PGW-C QoS

16. octets_in

64

UE

1048576 → 1 MB

PGW-U PFCP URR

- update
- end
- start 0
- URR `usage_report_interval`

17. octets_out

64

UE →

524288 → 512 KB

PGW-U PFCP URR

- `update` 000000
 - `end` 00000000
 - `start` 000000 0
 - `URR` 0000000000 `usage_report_interval` 000
-

00

00 1 0000000000000000

0000

1. 0000
2. 5 000000000000 10 MB 000 5 MB
3. 0000

CDR 000

```
# 00 CDR 000
# 0000000010:00:00 (1726570800)
# 0000000011:00:00 (1726574400)
# 000000pgw-c-01
# epoch,imsi,event,charging_id,msisdn,ue_imei,timezone_raw,plmn,tac,e
1726570800,310260111111111,default_bearer_start,10001,1555111111,11
1726571100,310260111111111,default_bearer_update,10001,1555111111,11
1726571400,310260111111111,default_bearer_end,10001,1555111111,1111
```

00 2 0000000000000000

0000

1. 00000000IPv4 + IPv6
2. 000000
3. 0000

CDR 000

```
1726570800,310260222222222, default_bearer_start,10002,15552222222,222
1726571100,310260222222222, default_bearer_update,10002,15552222222,22
1726571400,310260222222222, default_bearer_update,10002,15552222222,22
1726571700,310260222222222, default_bearer_update,10002,15552222222,22
1726572000,310260222222222, default_bearer_end,10002,15552222222,22222
```

00 300000000000000

0000

1. 00000000QCI 9
2. 000000000000QCI 6
3. 0000000000
4. 0000000
5. 0000000

CDR 000

```
1726570800,310260333333333, default_bearer_start,10003,15553333333,333
1726571100,310260333333333, dedicated_bearer_start,10004,15553333333,3
1726571400,310260333333333, default_bearer_update,10003,15553333333,33
1726571400,310260333333333, dedicated_bearer_update,10004,15553333333,
1726571700,310260333333333, dedicated_bearer_end,10004,15553333333,333
1726572000,310260333333333, default_bearer_end,10003,15553333333,33333
```

000

- 0000001000300000000000 10 MB000 4 MB
- 0000001000400000000000 200 MB000 2 MB
- 000 QCI 009 0 60000000 QoS 00

□□

CDR □□□□

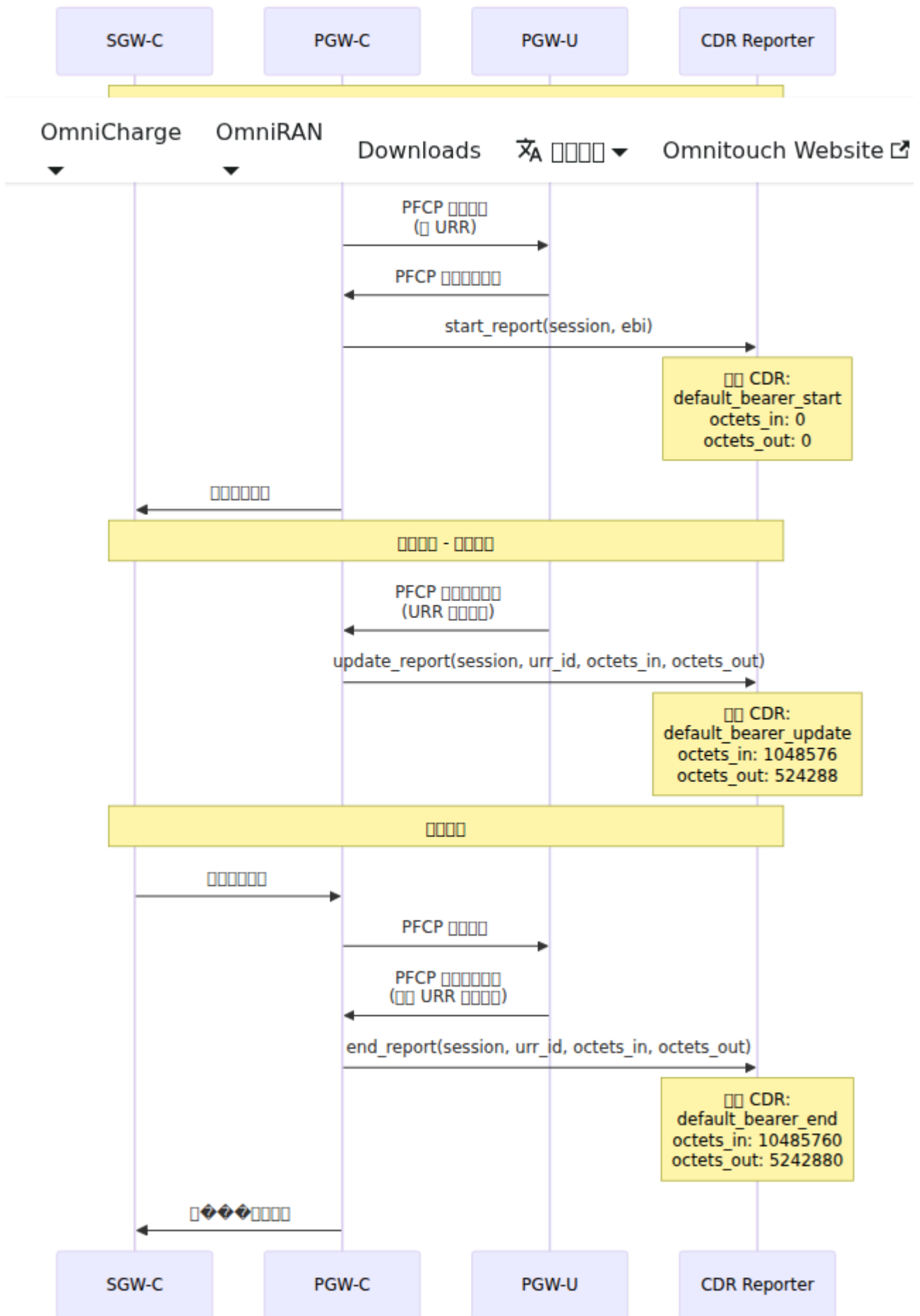

CDR 处理

1. 实时监控

```
# 实时监控 CDR 文件 PGW-C
inotifywait -m /var/log/pgw_c/cdrs/ -e close_write | while read
path action file; do
    # 实时监控 CDR
    process_cdr "$path$file"
done
```

2. 日志

```
# 实时监控 CDR 日志
tail -F /var/log/pgw_c/cdrs/* | process_cdr_stream
```

CDR 类型

- **CDR** - 实时监控 CDR 文件
- **PFCP** CDR - 实时监控 URRs 在 PGW-U 上的 CDR
- **CDR** - CDR 实时监控
- **CDR** - CDR 实时监控 URR
- **Gx** CDR - CDR 实时监控 QCI
- **Gy** CDR - 实时监控

3GPP 标准

- TS 32.251 - 实时监控 PS
- TS 29.274 - 3GPP 实时监控 EPS GTP-C
- TS 29.244 - CP 实时监控 PFCP - **URR**
- TS 32.298 - CDR

CDR □□ - PGW-C □□□□□□□□

□ Omnitouch □□□□□□

□□□□ 1.0 □□□□ 2025-12-28

Diameter Gx

(PCRF) 10

10

1. 10
2. Gx 10
3. Diameter 10
4. 10
5. 10
6. 10
7. 10
8. 10
9. 10

10

Gx 10 PGW-C 10 PCRF 10 PCF 10 5G 10

- 10 - 10 QoS 10
- 10 - 10
- 10 - 10
- 10 - 10

Network Gx

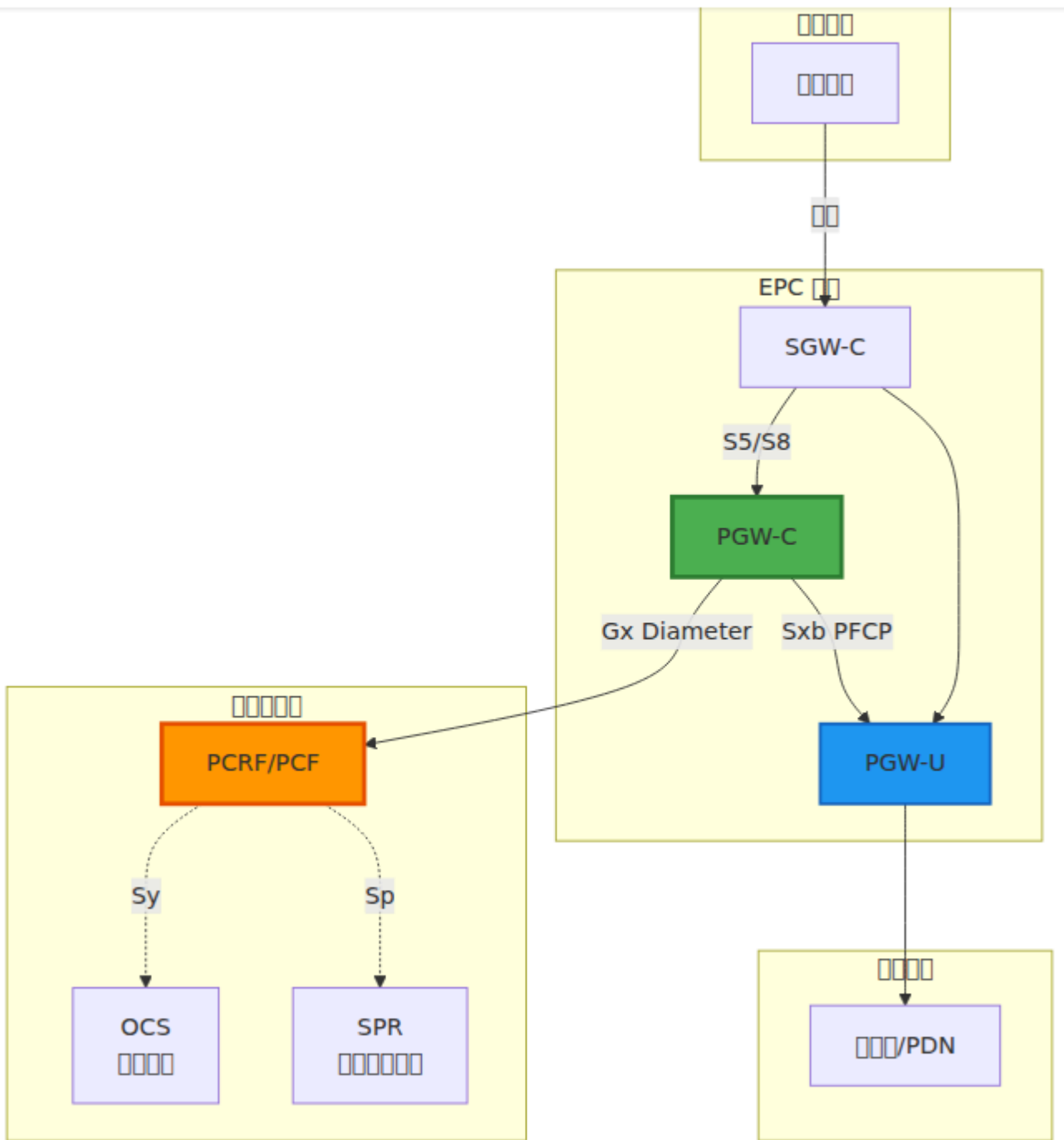

□□□□

□□	□□
□□□□	PCRF □□ PCC □□□□□□□□□□
QoS □□	□□□□□□□□ QoS □□
□□□□	□□□/□□□□□□□□□□
□□□□	□□□□□□/□□□□
□□□□	□□□□□□□□□□

Gx □□□□

3GPP □□

- □□□ 3GPP TS 29.212
- **Diameter** □□ **ID** 16777238 (Gx)
- □□□ Diameter □□□□ (RFC 6733)

□□□□

□□ UE PDN □□□□□□□□□□ **Gx** □□□□ **Session-ID** □□□□□□□□

- □ UE □□□□□ (CCR-Initial)
- □□□□□□□□□□ (CCR-Update) - □□
- □ UE □□□□□ (CCR-Termination)

Session ID

Session-ID: <Origin-Host>;<high32>;<low32>[;<optional>]

Example: omni-pgw_c.epc.mnc999.mcc999.3gppnetwork.org;1234567890;98765

Fields

- **Origin-Host**: PGW-C IP Address
- **high32**: High 32 bits of the Session ID
- **low32**: Low 32 bits of the Session ID

Diameter

Fields

Diameter fields are defined in RFC 6733

```

Diameter Header (20 bytes)
├─ Version (1 byte) = 1
├─ Message Length (3 bytes)
├─ Flags (1 byte)
│   ├─ R: Request (1) / Answer (0)
│   ├─ P: Proxiable
│   └─ E: Error
└─ T: Potentially retransmitted
├─ Command Code (3 bytes)
├─ Application ID (4 bytes) = 16777238 (Gx)
├─ Hop-by-Hop ID (4 bytes)
└─ End-to-End ID (4 bytes)

```

```

AVPs (00-00)
├─ AVP Header
│   ├─ AVP Code
│   ├─ Flags (V, M, P)
│   └─ AVP Length
└─ Vendor ID (optional)
    └─ AVP Data

```

00 Diameter 00

AVP000-0000

- Diameter 00000000
- 0000000000
- 00000000 AVP0

000

- 00/000
- CCR000000000/ CCA000000000

00000

- 2001 - DIAMETER_SUCCESS
- 3xxx - 0000
- 4xxx - 0000

- 5xxx - □□□□

□□□□□□

PGW-C □□ **Diameter** □□□□□□□□ RFC 4006 □□□□ Gx□

□□□□

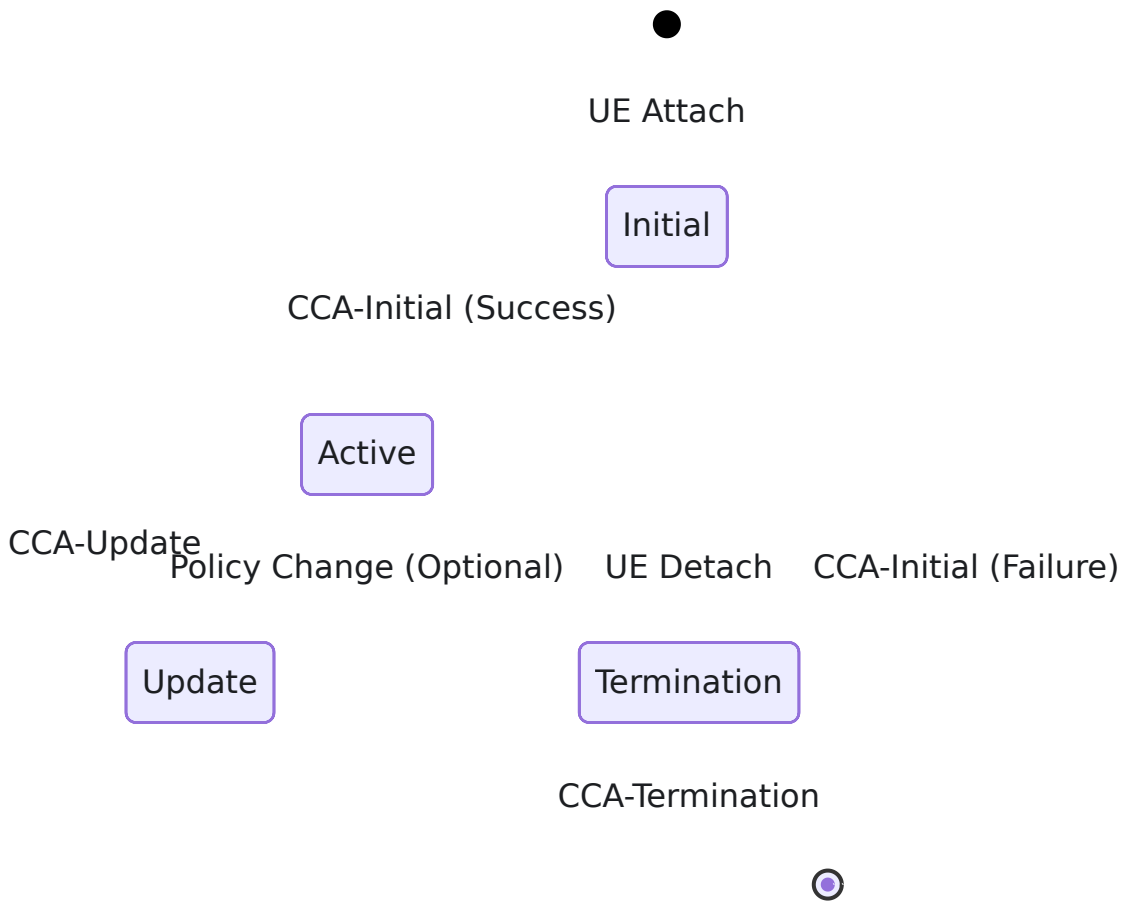

CCR-Initial□□□□□□□□ - □□□□

□□□□ UE □□□□ PDN □□

□□□□

- □□□□□□□□□□□□
- □ PCRF □□ UE □□□□□□

- QoS

PGW-C AVP

AVP	AVP		
Session-Id	263	UTF8String	Gx
Auth-Application-Id	258	Unsigned32	16777238 (Gx)
Origin-Host	264	DiamIdent	PGW-C Diameter
Origin-Realm	296	DiamIdent	PGW-C Diameter
Destination-Realm	283	DiamIdent	PCRF
CC-Request-Type	416	Enumerated	1 = INITIAL_REQUEST
CC-Request-Number	415	Unsigned32	0
Subscription-Id	443	Grouped	UE IMSI/MSISDN
Called-Station-Id	30	UTF8String	APN
Framed-IP-Address	8	OctetString	UE IPv4
IP-CAN-Type	1027	Enumerated	5 = 3GPP-EPS
RAT-Type	1032	Enumerated	1004 = EUTRAN
QoS-Information	1016	Grouped	QoS (AMBR)
Network-Request-Support	1024	Enumerated	
Supported-Features	628	Grouped	Gx

CCR-I

```
CCR (Command Code: 272, Request)
├─ Session-Id: "pgw_c.example.com;123;456"
├─ Auth-Application-Id: 16777238
├─ Origin-Host: "omni-pgw_c.epc.mnc999.mcc999.3gppnetwork.org"
├─ Origin-Realm: "epc.mnc999.mcc999.3gppnetwork.org"
├─ Destination-Realm: "epc.mnc999.mcc999.3gppnetwork.org"
├─ CC-Request-Type: INITIAL_REQUEST (1)
├─ CC-Request-Number: 0
├─ Subscription-Id (Grouped)
│   └─ Subscription-Id-Type: END_USER_IMSI (1)
│       └─ Subscription-Id-Data: "310260123456789"
├─ Called-Station-Id: "internet"
├─ Framed-IP-Address: 100.64.1.42
├─ IP-CAN-Type: 3GPP-EPS (5)
├─ RAT-Type: EUTRAN (1004)
├─ QoS-Information (Grouped)
│   └─ APN-Aggregate-Max-Bitrate-UL: 100000000 (100 Mbps)
│       └─ APN-Aggregate-Max-Bitrate-DL: 50000000 (50 Mbps)
├─ Network-Request-Support: 1
└─ Supported-Features: [...]
```

CCA-Initial -

PCRF CCR-I

-
- PCC
- QoS

PGW-C AVP

AVP 名称	AVP 代码	描述
Result-Code	268	成功 (2001) 成功
Experimental-Result	297	实验性结果
QoS-Information	1016	QoS 信息
Charging-Rule-Install	1001	安装 PCC 规则
Charging-Rule-Definition	1003	定义 PCC 规则
Default-EPS-Bearer-QoS	1049	默认 EPS 承载 QoS

成功

```

CCA (Command Code: 272, Answer)
├─ Session-Id: "pgw_c.example.com;123;456"
├─ Result-Code: DIAMETER_SUCCESS (2001)
├─ Origin-Host: "pcrf.example.com"
├─ Origin-Realm: "example.com"
├─ Auth-Application-Id: 16777238
├─ CC-Request-Type: INITIAL_REQUEST (1)
├─ CC-Request-Number: 0
├─ QoS-Information (Grouped)
│   ├─ APN-Aggregate-Max-Bitrate-UL: 50000000 (50 Mbps - reduced)
│   └─ APN-Aggregate-Max-Bitrate-DL: 100000000 (100 Mbps -
increased)
├─ Charging-Rule-Install (Grouped)
│   ├─ Charging-Rule-Name: "default_internet_rule"
│   └─ Charging-Rule-Name: "video_streaming_rule"
└─ Charging-Rule-Definition (Grouped)
    ├─ Charging-Rule-Name: "default_internet_rule"
    ├─ QoS-Information: {...}
    └─ Precedence: 1000

```

CCR-Termination 成功 - 成功

成功 UE 成功 PDN 成功

□□□

- □□ PCRF □□□□
- □□□□/□□□□

□ CCR-I □□□□□□

- `CC-Request-Type: TERMINATION_REQUEST (3)`
- □□□□□□□□
- □□□ AVP □□

□□ CCR-T□

```
CCR (Command Code: 272, Request)
├─ Session-Id: "pgw_c.example.com;123;456"
├─ Auth-Application-Id: 16777238
├─ Origin-Host: "omni-pgw_c.epc.mnc999.mcc999.3gppnetwork.org"
├─ Origin-Realm: "epc.mnc999.mcc999.3gppnetwork.org"
├─ Destination-Realm: "epc.mnc999.mcc999.3gppnetwork.org"
├─ CC-Request-Type: TERMINATION_REQUEST (3)
├─ CC-Request-Number: 1
└─ Termination-Cause: DIAMETER_LOGOUT (1)
```

CCA-Termination

□□□□ PCRF □ CCR-T □□□

□□□

- □□□□□□
- □□□□□□□□

□□ CCA-T□

CCA (Command Code: 272, Answer)
├─ Session-Id: "pgw_c.example.com;123;456"
├─ Result-Code: DIAMETER_SUCCESS (2001)
├─ Origin-Host: "pcrf.example.com"
├─ Origin-Realm: "example.com"
├─ Auth-Application-Id: 16777238
├─ CC-Request-Type: TERMINATION_REQUEST (3)
└─ CC-Request-Number: 1

□□□□□□□□

PCC □□□□

PCC□□□□□□□□□□ □□□□□□□□□□□□

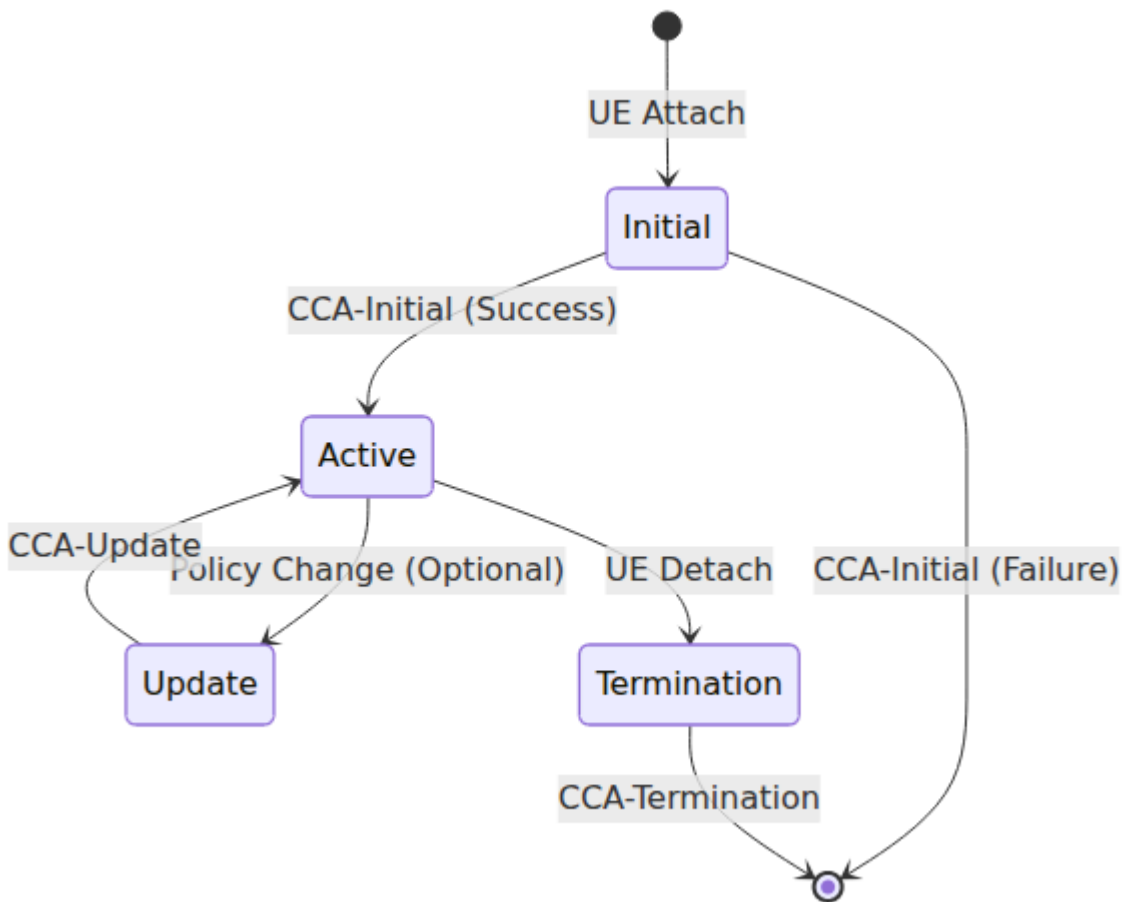

□□□□

1. □□□□

- □□□□□□□□
- □□□ "video_streaming_rule"

2. □□□□

- □□□□ = □□□□□□
- □□□0-65535
- □□□□□□□□□□

3. □□□□TFT - □□□□□□□□

- □□□□□□□□□□□□□□
- □□□
 - IP 5 □□□□□□□□/□□ IP□□/□□□□
 - "permit out ip from any to 8.8.8.8 80"

4. QoS □□□

- **QCI**□**QoS** □□□□□□ 1-9□□□□□□□□128-254□□□□□□□□
 - QCI 1□□□□□□□
 - QCI 5□IMS □□
 - QCI 9□□□□□□□□
- **ARP**□□□□□□□□□□□□□□ □□□□
- **MBR/GBR**□ □□/□□□□□□

5. □□□□□

- □□□□□ □□□□□□□□□□ OCS □□ - □ **Diameter Gy** □□□□
- □□□□□□ □□□□□□□□□□□□□□
- □□/□□□□□□ OCS□□□□ **Diameter Gy** □□□□□□□□□□ CDR□□□□□ - □ □□ **CDR** □□□□

6. □□□□□

- □□□□ □□□□□

- [] [] [] []

[][][][][]

PCRF [] [] [] [] [] [] [] [] [] []

1. [] [] [] [] [] [] [] [] [] []

Charging-Rule-Install (Grouped)

└─ Charging-Rule-Name: "gold_subscriber_internet"

└─ Charging-Rule-Name: "video_qos_boost"

2. [] [] [] [] [] [] [] [] [] []

Charging-Rule-Definition (Grouped)

└─ Charging-Rule-Name: "dynamic_rule_123"

└─ Precedence: 100

└─ Flow-Information (Grouped)

| └─ Flow-Description: "permit out ip from any to 192.0.2.0/24"

| └─ Flow-Direction: DOWNLINK

└─ QoS-Information (Grouped)

| └─ QoS-Class-Identifier: 5

| └─ Max-Requested-Bandwidth-UL: 10000000

| └─ Max-Requested-Bandwidth-DL: 50000000

└─ Rating-Group: 1000

QoS [] AVP

APN-AMBR [] [] [] [] [] [] [] [] [] []

[][] [] APN [] [] [] GBR [] [] []

QoS-Information (Grouped)

└─ APN-Aggregate-Max-Bitrate-UL: 100000000 # 100 Mbps

└─ APN-Aggregate-Max-Bitrate-DL: 200000000 # 200 Mbps

PGW-C [] [] []

- AMBR
 - PGW-U QER
-

Gx

`config/runtime.exe`

```

config :pgw_c,
  diameter: %{
    # Diameter IP
    listen_ip: "0.0.0.0",

    # PGW-C Diameter (Origin-Host)
    host: "omni-pgw_c.epc.mnc999.mcc999.3gppnetwork.org",

    # PGW-C Diameter (Origin-Realm)
    realm: "epc.mnc999.mcc999.3gppnetwork.org",

    # PCRF
    peer_list: [
      %{
        # PCRF Diameter
        host: "pcrf.epc.mnc999.mcc999.3gppnetwork.org",

        # PCRF PGW-C
        realm: "epc.mnc999.mcc999.3gppnetwork.org",

        # PCRF IP
        ip: "10.0.0.30",

        # PGW-C PCRF
        # true = PGW-C PCRF
        # false = PCRF
        initiate_connection: true
      }
    ]
  }
}

```

PCRF

```

config :pgw_c,
  diameter: %{
    listen_ip: "0.0.0.0",
    host: "omni-pgw_c.epc.mnc999.mcc999.3gppnetwork.org",
    realm: "epc.mnc999.mcc999.3gppnetwork.org",
    peer_list: [
      %{
        host: "pcrf-primary.example.com",
        realm: "epc.mnc999.mcc999.3gppnetwork.org",
        ip: "10.0.1.30",
        initiate_connection: true
      },
      %{
        host: "pcrf-backup.example.com",
        realm: "epc.mnc999.mcc999.3gppnetwork.org",
        ip: "10.0.2.30",
        initiate_connection: true
      }
    ]
  }
}

```

□□□□□

- Diameter □□□□□□□□□□
- □□□□□□□□□□
- □□□□□□□□□□□□□□

□□□□□□

Diameter □□□□□ FQDN□□□□□□□□□□

```

# □□ - FQDN □□
host: "pgw_c.epc.mnc999.mcc999.3gppnetwork.org"

# □□□ - □□□□□□ Diameter □□
host: "pgw_c"
host: "10.0.0.20" # □□□ IP □□

```

□□□□□

- □□□□□□□□
 - □□□ 3GPP PLMN □□□□□ `epc.mncXXX.mccYYY.3gppnetwork.org`
-

□□□

□□□□□□□

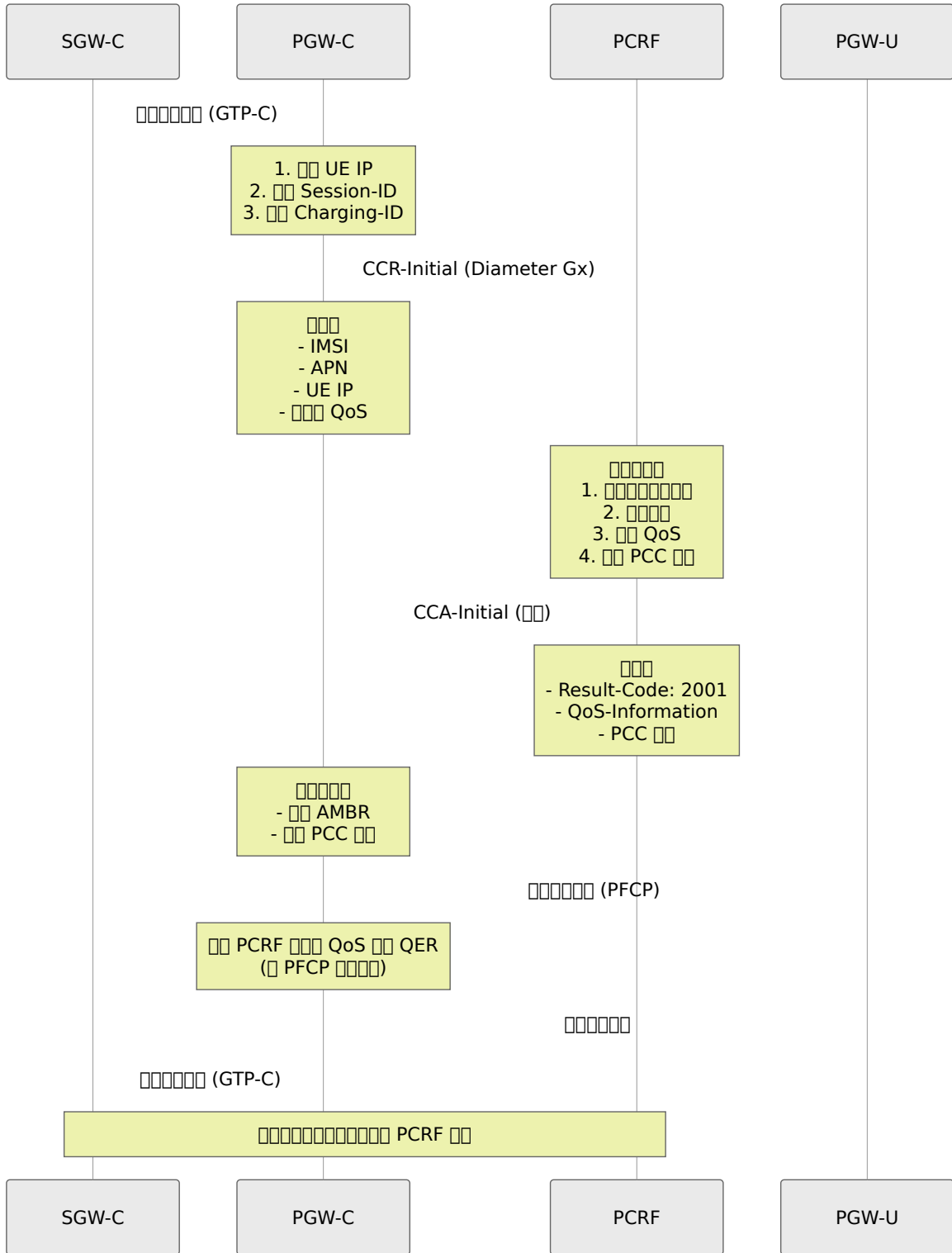

□□ PCRF □ QoS □□□□ QER□QoS □□□□□□□ PFCP □□ PGW-U□□□ QER □□□□□□
 □ PFCP □□□

□□□□□□□□□□

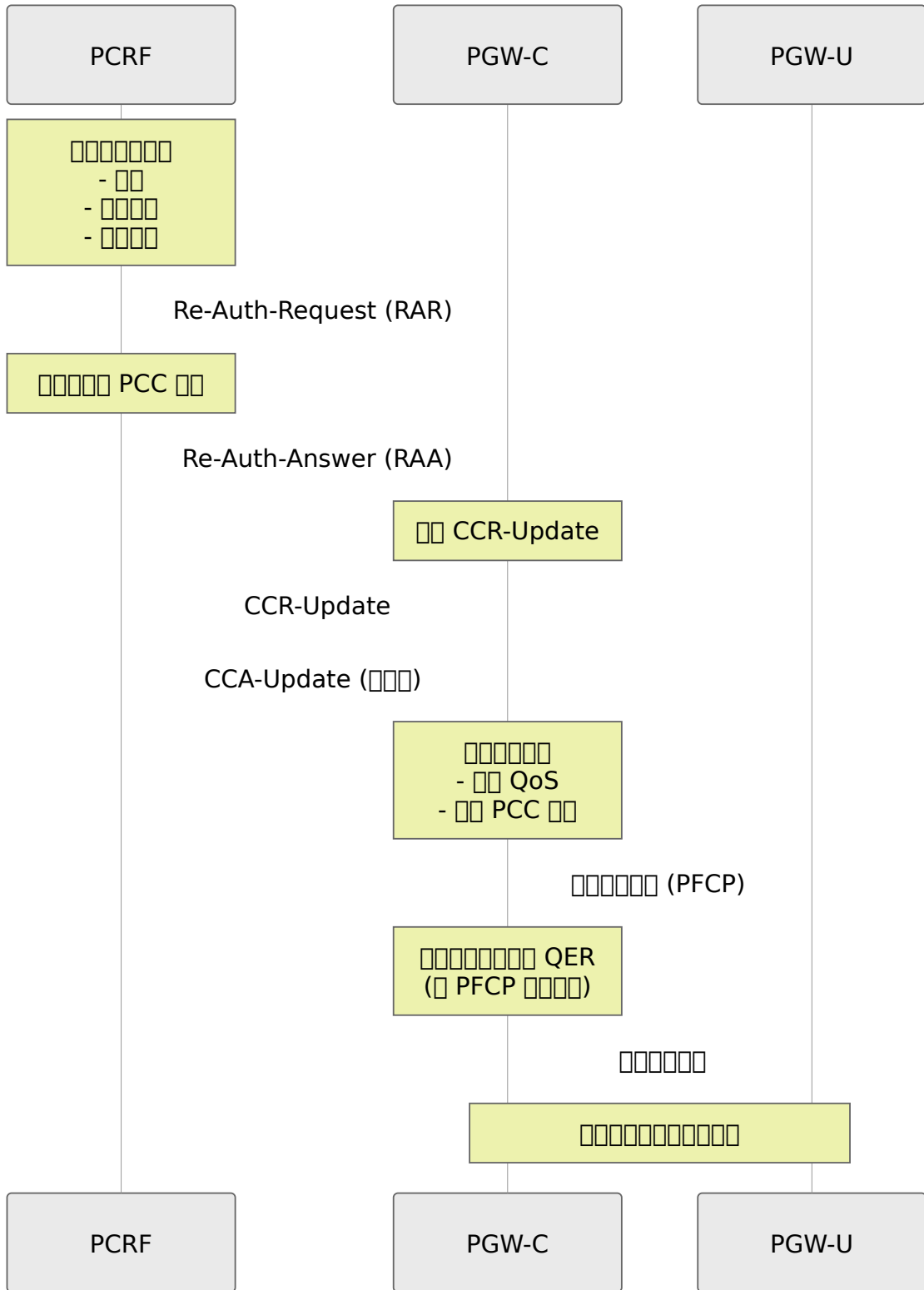

□□□□

OmniCharge

OmniRAN

Downloads

⌵ □□□□

OmniTouch Website [↗](#)

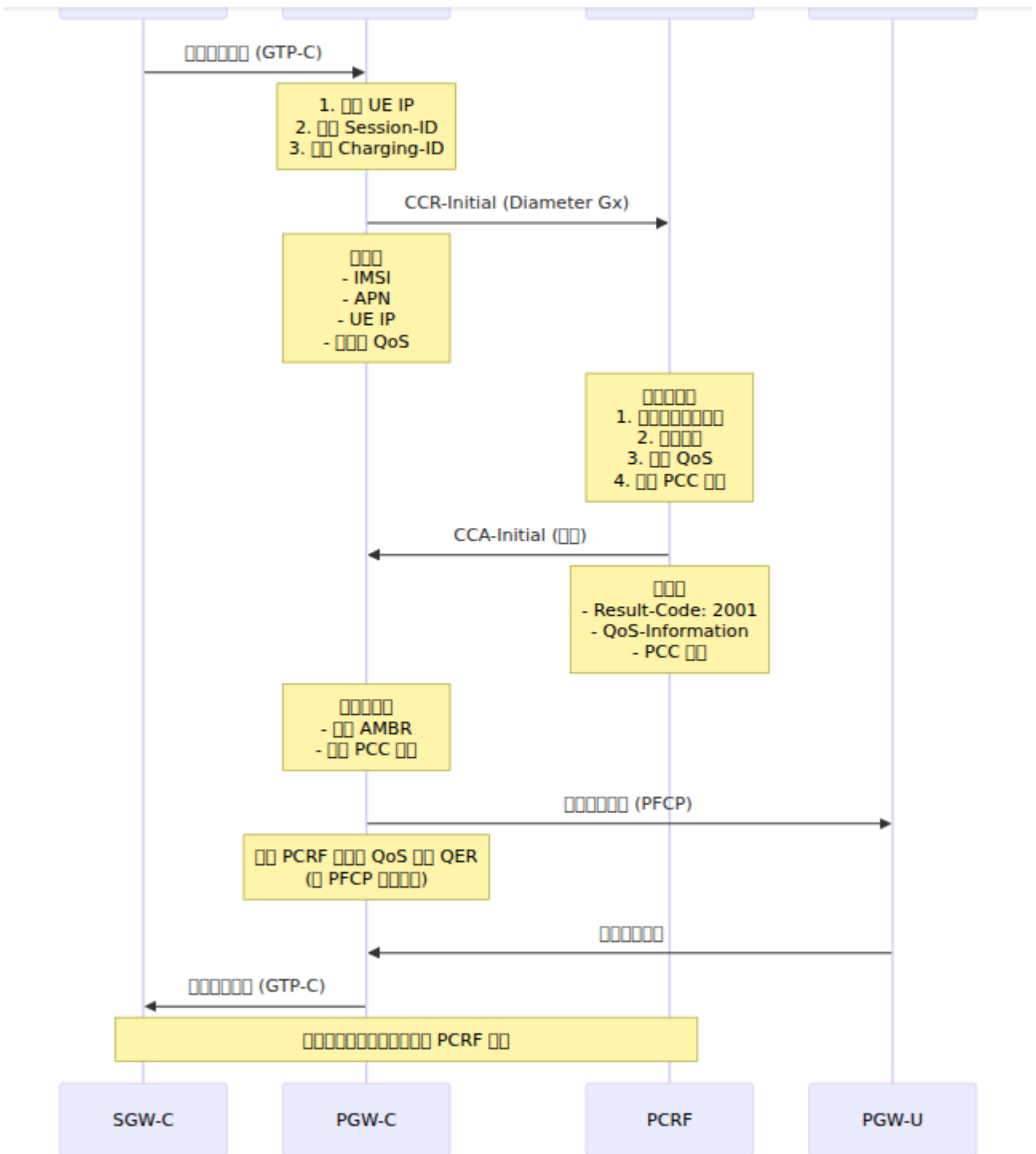

□□□□

□□□□

PGW-C □ CCA □□□□□□ Diameter □□□□□

□□□□□

□□	□□	□□
2001	DIAMETER_SUCCESS	□□□□□□

□□□□ (5xxx)□

□□	□□	PGW-C □□
5002	DIAMETER_UNKNOWN_SESSION_ID	□□□□□□□□
5030	DIAMETER_USER_UNKNOWN	□□□□□□□□
5140	DIAMETER_ERROR_INITIAL_PARAMETERS	□□□□□□□□
5003	DIAMETER_AUTHORIZATION_REJECTED	□□□□□□□□

□□□□ (4xxx)□

□□	□□	PGW-C □□
4001	DIAMETER_AUTHENTICATION_REJECTED	□□□□□□
4010	DIAMETER_TOO_BUSY	□□□□
4012	DIAMETER_UNABLE_TO_COMPLY	□□□□□□□□

실패 원인

실패 메시지

Experimental-Result (Grouped)

└─ Vendor-Id: 10415 (3GPP)

└─ Experimental-Result-Code: <vendor-specific code>

3GPP 실패 코드

코드	메시지	설명
5065	IP_CAN_SESSION_NOT_AVAILABLE	PCRF 실패
5143	INVALID_SERVICE_INFORMATION	실패

원인

CCR-I 실패

3GPP 실패 코드 CCR-Initial

1. PGW-C 실패 (5G 실패)
2. 실패 원인 CCA
 - "Session-ID CCR-Initial 실패..."
 - SGW-C 실패
 - 실패
3. SGW-C 실패

SGW-C 실패

CCR-Initial 실패 PGW-C SGW-C 실패

:remote_peer_not_responding

원인

1. PCRF 실패

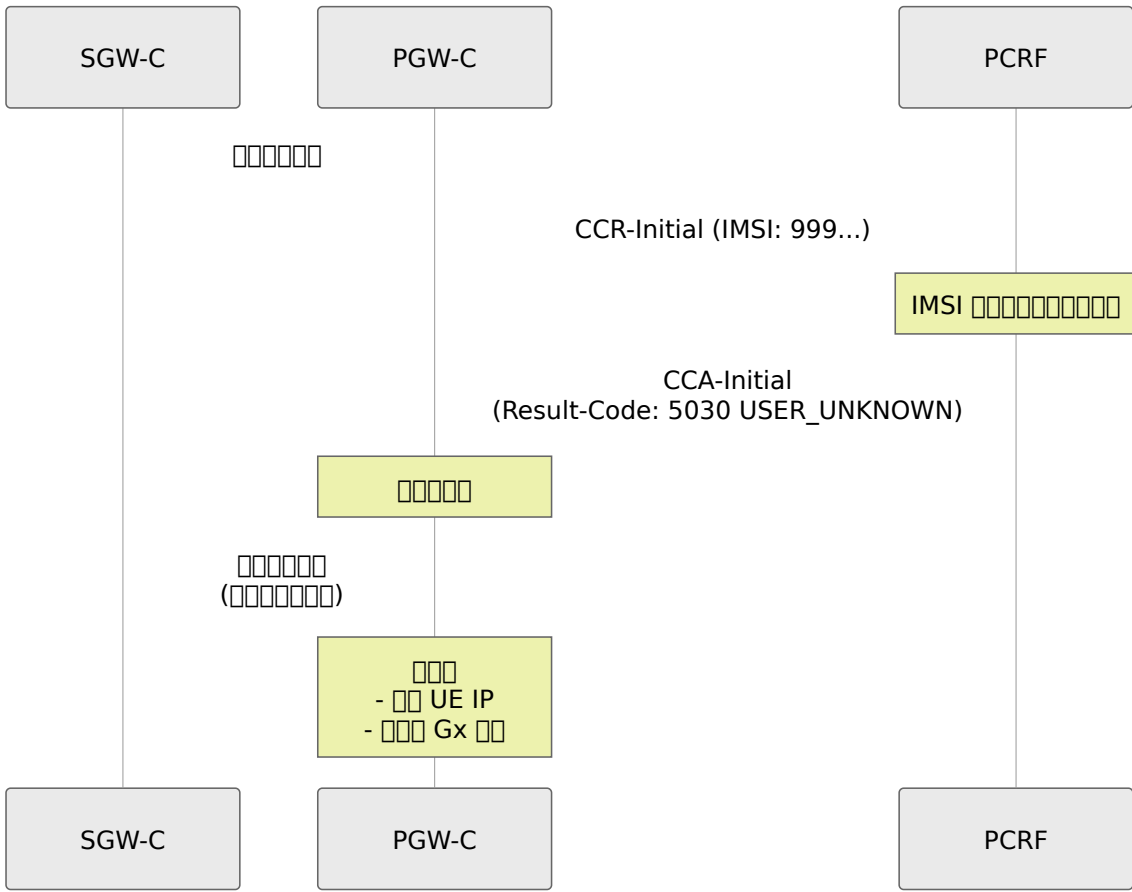

□□ 2□PCRF □□□□□□

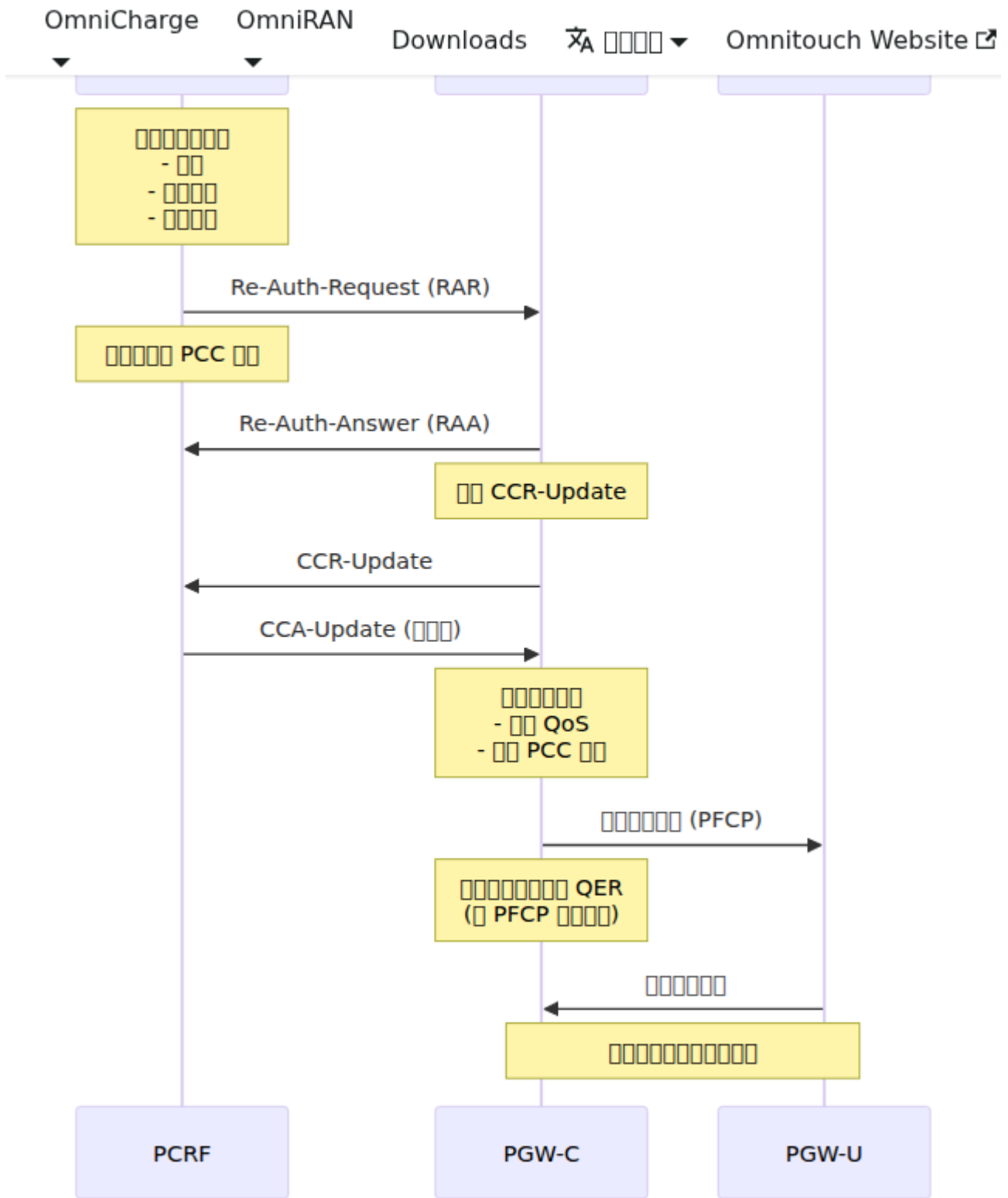

□□□□

□□□□

1. Diameter □□□□□□

□□□

- □□□“Diameter □□□□□□”
- □□□ CCR-Initial

□□□□□

- PCRF □□□□
- □□□ PCRF IP □□□
- □□□□□ Diameter □□□3868□
- Diameter □□□□□/□□□□□□

□□□□□

```
# □□□□□□  
ping <pcrf_ip>  
  
# □□ Diameter □□□TCP 3868□  
telnet <pcrf_ip> 3868  
  
# □□ Diameter □□□□  
# □□□□□□□□ FQDN□□□□ IP
```

□□□□□

```

config :pgw_c,
  diameter: %{
    # FQDN IP
    host: "pgw_c.epc.mnc999.mcc999.3gppnetwork.org",
    realm: "epc.mnc999.mcc999.3gppnetwork.org",
    peer_list: [
      %{
        host: "pcrf.epc.mnc999.mcc999.3gppnetwork.org",
        ip: "10.0.0.30"
      }
    ]
  }
}

```

2. CCR-Initial

-
- “CCR-Initial”

- PCRF
-
- PCRF Session-ID

1. PCRF
2. PCRF
3. ping <pcrf_ip>
- 4.

3. PCRF

- CCA-Initial Result-Code != 2001
-

□□□□□□

□□□□	□□□□	□□□□
5030	IMSI □□□□□□□□	□ HSS/SPR □□□□□
5003	□□□□□	□□□□□□
4010	PCRF □□□□	□□□□□ PCRF □□

□□□□□

```
# PGW-C □□□□□  
[error] Diameter Gx □□□□□□□ 5030 (DIAMETER_USER_UNKNOWN)  
[error] IMSI 3102609999999999 □ PCRF □□
```

4. QoS □□□

□□□

- □□□□□□ QoS □□
- □□□□□□□□□□

□□□□□

1. □□ **CCA-Initial**□

- □□ QoS-Information AVP □□□□
- □□ APN-Aggregate-Max-Bitrate-UL/DL □

2. □□ **PFCP** □□□□□

- □□ QER □□□□□□□ MBR □□□
- □□ PGW-U □□□□□ QER □□

3. □□ **PCRF** □□□

- □□ PCRF □□

- `QoS`

5. Diameter `PCRF`

`PCRF`

- Diameter `PCRF`
- `"PCRF"`

`PCRF`

- `PCRF`

`PCRF`

`PCRF`

```
# PCRF
config :pgw_c,
  diameter: %{
    realm: "epc.mnc999.mcc999.3gppnetwork.org", # PGW-C PCRF
    peer_list: [
      %{
        realm: "epc.mnc999.mcc999.3gppnetwork.org" # PCRF PCRF
      }
    ]
  }
}
```

`CCR-Initial`

```
Origin-Realm: "epc.mnc999.mcc999.3gppnetwork.org"
Destination-Realm: "epc.mnc999.mcc999.3gppnetwork.org"
```

`Gx`

`Gx`

```

# Gx 消息
rate(gx_inbound_messages_total{message_type="gx_CCA"}[5m])
rate(gx_outbound_messages_total{message_type="gx_CCR"}[5m])

# Gx 错误
rate(gx_inbound_errors_total[5m])

# Gx 成功率
sum(rate(gx_outbound_responses_total{result_code_class="2xxx"}
[5m])) /
sum(rate(gx_outbound_responses_total[5m])) * 100

# 按 PCRF 实例 Gx 消息
rate(gx_outbound_responses_total{result_code_class!="2xxx"}[5m])
by (diameter_host)

# Gx 会话
session_id_registry_count

# Gx 处理时长
histogram_quantile(0.95,
rate(gx_inbound_handling_duration_bucket[5m]))

```

监控项名称

gx_outbound_responses_total   按 PCRF 实例 Diameter 消息成功率

- **message_type** 消息类型 gx_RAA gx_CCA
- **result_code_class** 结果码类 2xxx 3xxx 4xxx 5xxx
- **diameter_host** PCRF 实例

报警规则

- **2001** DIAMETER_SUCCESS - 成功
- **3001** DIAMETER_COMMAND_UNSUPPORTED - 不支持
- **5012** DIAMETER_UNABLE_TO_COMPLY - 无法遵守
- **5030** DIAMETER_USER_UNKNOWN - 用户未知

报警策略

```

# Gx Errors
- alert: GxErrorRateHigh
  expr: rate(gx_inbound_errors_total[5m]) > 0.1
  for: 5m
  annotations:
    summary: "Gx Errors"

# Gx Response Failure Rate
- alert: GxResponseFailureRate
  expr: |

sum(rate(gx_outbound_responses_total{result_code_class!="2xxx"}
[5m])) /
  sum(rate(gx_outbound_responses_total[5m])) > 0.1
  for: 5m
  annotations:
    summary: "Gx Response Failure Rate"
    description: "10% Gx Response Failure Rate"

# PCRF Failures
- alert: GxPCRFFailures
  expr:
rate(gx_outbound_responses_total{result_code_class=~"4xxx|5xxx"}
[5m]) by (diameter_host) > 0.05
  for: 3m
  annotations:
    summary: "PCRF {{ $labels.diameter_host }} Failures"
    description: "PCRF Failures"

# Session Rejection
- alert: GxSessionRejection
  expr: rate(gx_inbound_errors_total{result_code="5030"}[5m]) >
0.01
  for: 5m
  annotations:
    summary: "PCRF USER_UNKNOWN"

```

PCRF

PCRF Diameter Errors

```
# config/runtime.exs
config :logger, level: :debug
```

```
# 配置
iex> Logger.configure(level: :debug)
```

配置

- [debug] 配置 CCR-Initial配置Session-ID: ...
- [debug] 配置 CCA-Initial配置Result-Code 2001
- [error] Diameter 配置...

Web UI - Diameter 配置

OmniPGW 配置 Web UI配置 Diameter 配置

Diameter 配置

配置 <http://<omnipgw-ip>:<web-port>/diameter>

PCRF Diameter Gx PCRF

1. PCRF

- PCRF - PCRF
- PCRF - PCRF
- 1 PCRF

2. PCRF

- Origin-Host - Diameter (Origin-Host)
- IP - PCRF IP
- 3868 - Diameter 3868
- /
- TCP SCTP
- PGW PCRF
- Diameter
- PCRF
- ID - Diameter Gx = 16777238

3. PCRF

- PCRF
- CER/CEA
- PCRF
- PCRF

PCRF

1. 00000000 Diameter 00
2. 0000 PCRF 00000“0000”
3. 0000000000000000
4. 0000 ID 00 Gx0167772380

00000000000000**Gx** 0000

1. 0000000000“PCRF 00”00
2. 00 Diameter 00
3. 0000000000
 - 00000
 - 00000000
 - 00 PCRF 00000000
 - 00 TCP 3868 00000000
 - 000000000000
 - 0000000000000000
 - PCRF 00000000

00 **Diameter** 0000

1. 0000 PCRF 0000
2. 00 Diameter 00
3. 00000000000000
4. 0000000000“000000”
5. 00000000000
 - 0000000000
 - 00 ID 00 Gx
 - 00000000 PCRF 0000

0000000000

- 0000 PCRF 00
1. Diameter 00000“0000”
 2. 0000 PCRF 0“0000”
 3. 000000000000
 4. 000000000000“0000”

00 **Diameter** 000000

- 配置“名称”
- ID 为 Gx16777238
- 配置 PCRF 地址

配置

```
Web UI 配置
  配置“名称”
  配置
  initiate_connection: true
```

- ```
配置
- OmniPGW 配置
- 配置 PCRF 地址
- 配置名称
```

配置

- 配置 - 1 配置
- 配置 - 配置/配置
- 配置 **Diameter** 配置 - 配置 Diameter CLI 配置
- 配置 - 配置
- 配置 - 配置 Diameter 配置
- 配置 - 配置 Diameter 配置

配置

配置 Web UI 配置 Prometheus 配置

- 配置 Gx 配置
- CCR/CCA 配置
- 配置

Web UI = “配置” 配置 = “配置”

---

## □□□□

### □□□□□

- □□□□ - Diameter □□□PCRF □□□□□
- **PFCP** □□ - □□ PCC □□□ QER □□ QoS □□
- □□□□ - □□□□□□□□□□□□
- **QoS** □□□□□ - □□□ QoS □□□□□□□

### □□□□

- **Diameter Gy** □□ - □□ PCC □□□□□□□□□□
- □□ **CDR** □□ - □□□□□□□□□□□□
- **PCO** □□ - IMS □□□□□ P-CSCF □□

### □□

- □□□□ - Gx □□□□□□□□□□□□□□□□
- **S5/S8** □□ - □□□□□□□□□□

---

### □□□□□□

# IMS Gy/Ro

OCS

---

## 

- - 3GPP
  - Gy/Ro
  - 
  - 
  - 
  - 
  - 
  - 
  - 
  - 
  - Gx
  -
- 

## 

Gy IMS Ro PGW-C\*\* OCS\*\*

- 
- 
- 
- 
-

□□□□□□□

| □□   | □□□□□Gy/Ro□ | □□□□□Gz/Rf□     |
|------|-------------|-----------------|
| □□   | □□□□□□□     | □□□□□           |
| □□   | □□□□□       | □□□□□           |
| □□□□ | □□□□□□□□□   | □□□□□□□□        |
| □□   | OCS□□□□□□□□ | CGF/CDF□□□□□□□□ |
| □□   | □□□□□       | □□□□□□□□□       |
| □□□  | □□□□□□□     | □□□□□□□         |
| □□□□ | □□□□□□□□□□□ | □□□□□□          |

□□□ □□CDR□□ □□□□□□□□□□□□□□□

□□□ □□□□ □□□□□PDN□□□□□□□□□□□□□□

□□□□□Gy

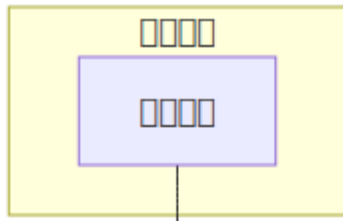

OmniCharge

OmniRAN

Downloads

☒ ☐☐☐☐ ▼

Omnito

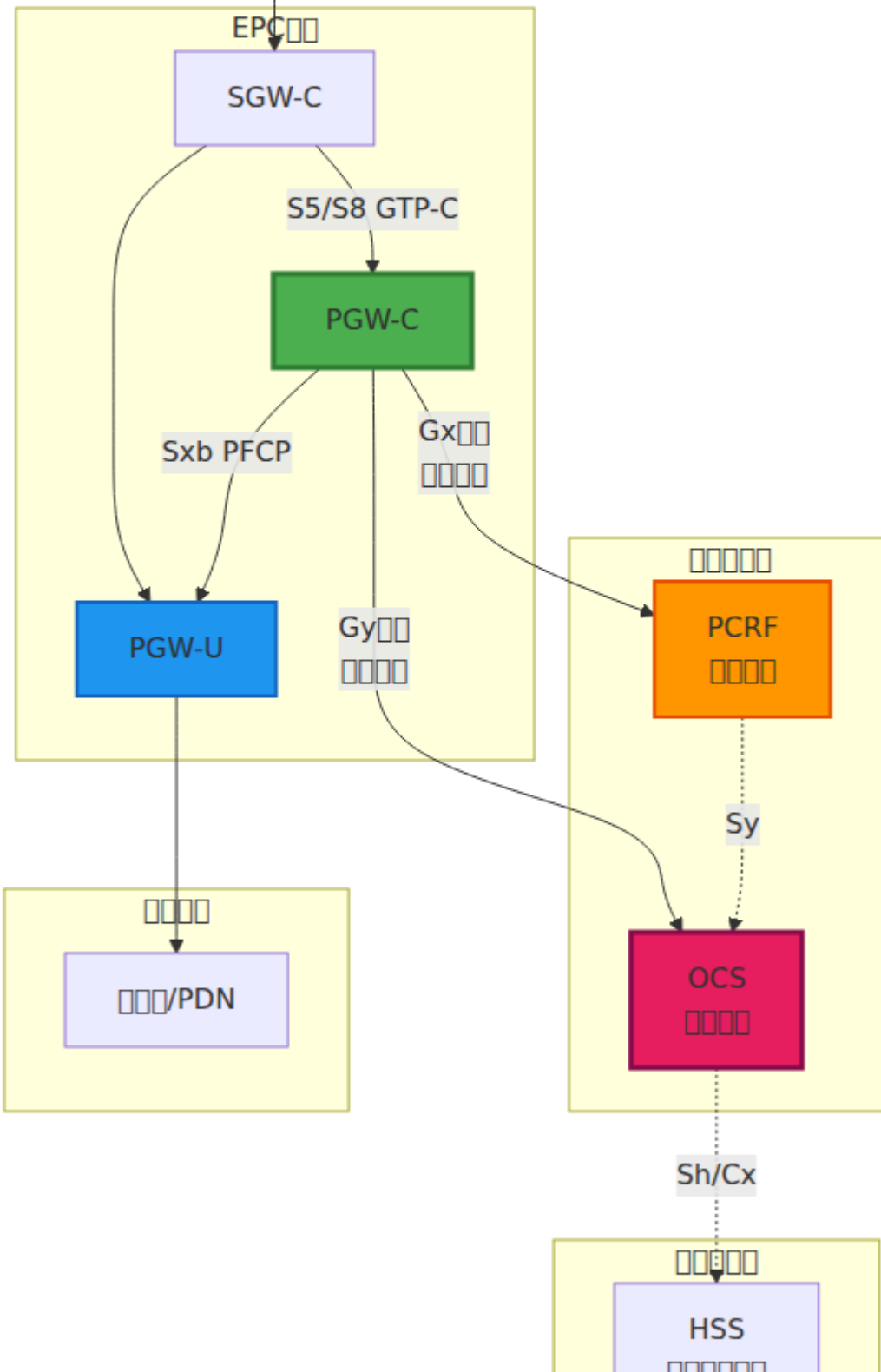

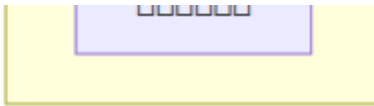

0000

| 00     | 00                 |
|--------|--------------------|
| 0000   | 0000000000OCS000   |
| 0000   | 000000000000000000 |
| 000000 | 000000             |
| 0000   | 00000000000000     |
| 0000   | 000000000000       |
| 0000   | 00000000000000     |

---

# 3GPP

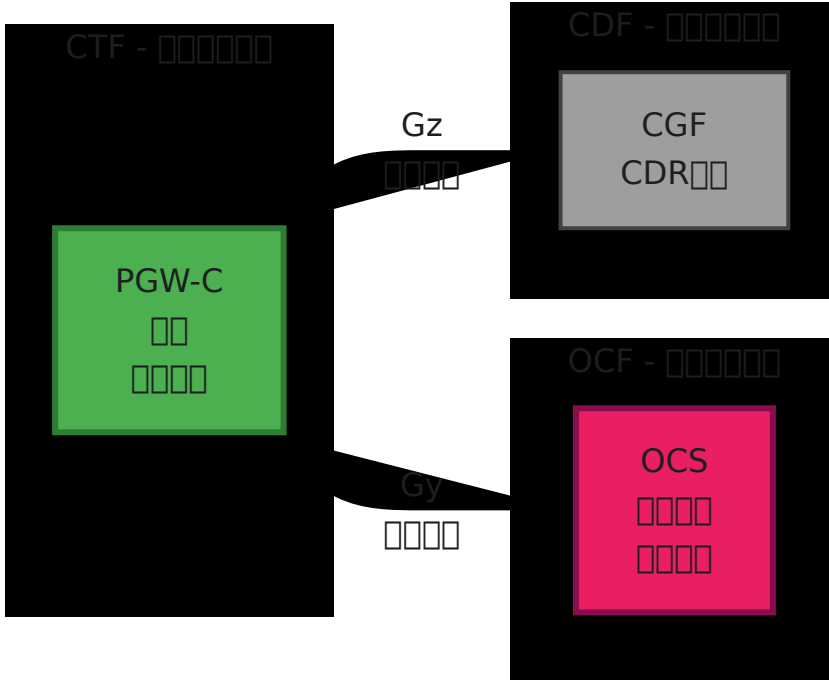

## CTF

PGW-C CTF

1. -
2. -
3. -
4. -
5. -

## OCF

OCS OCF

1. -
2. - MB
3. -

4. 4G - 4G LTE
5. 4G - 4G LTE

## Gy/Ro

### 3GPP

- 3GPP TS 32.299
- 3GPP TS 32.251 PS
- ID** 4 Gy/Ro -
- RFC 4006

### 

UE PDN **Session-ID** **Gy/Ro**

- CCR-Initial
- CCR-Update
- CCR-Termination

### ID

```
Session-ID: <Origin-Host>;<high32>;<low32>[;<optional>]
: omni-
pgw_c.epc.mnc999.mcc999.3gppnetwork.org;9876543210;12345;gy
```

### 

- Origin-Host:** PGW-C
- high32:** 32
- low32:** 32
- optional:** "gy" Gx

□□□□□□

□□□□

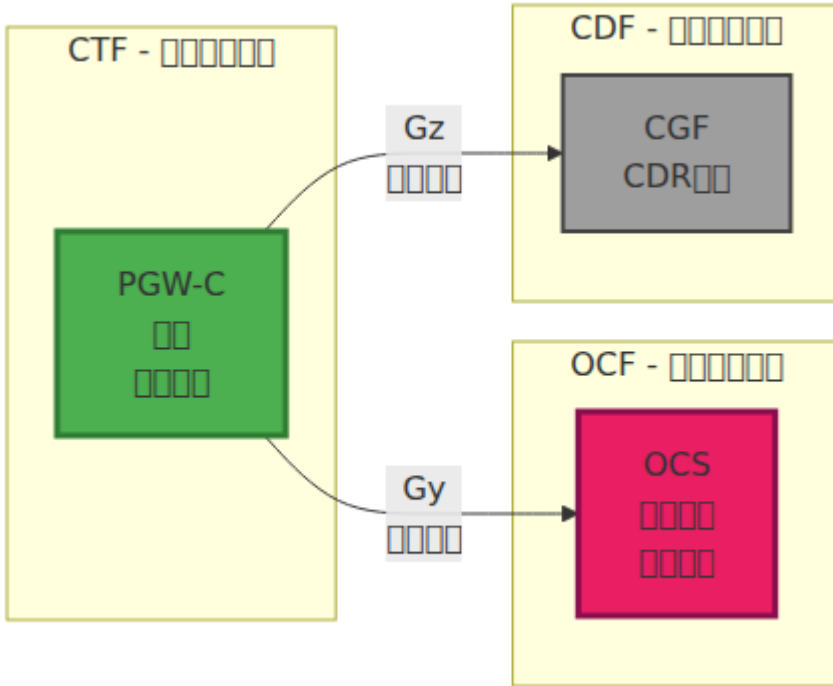

## CCR-Initial□□□□□□□ - □□□

□□□ UE□□PDN□□□□□□□□□□□□□□

□□□

- □□OCS□□□□□□□□
- □□□□□□□□□□
- □□Gy/Ro□□

**PGW-C**□□□□□□**AVP**□

| <b>AVP</b>                       | <b>AVP</b> |            |                     |
|----------------------------------|------------|------------|---------------------|
| Session-Id                       | 263        | UTF8String | Gy                  |
| Auth-Application-Id              | 258        | Unsigned32 | 4                   |
| Origin-Host                      | 264        | DiamIdent  | PGW-C               |
| Origin-Realm                     | 296        | DiamIdent  | PGW-C               |
| Destination-Realm                | 283        | DiamIdent  | OCS                 |
| CC-Request-Type                  | 416        | Enumerated | 1 = INITIAL_REQUEST |
| CC-Request-Number                | 415        | Unsigned32 | 0                   |
| Subscription-Id                  | 443        | Grouped    | UE<br>IMS/MSISDN    |
| Service-Context-Id               | 461        | UTF8String |                     |
| Multiple-Services-Credit-Control | 456        | Grouped    |                     |
| Requested-Service-Unit           | 437        | Grouped    |                     |
| Used-Service-Unit                | 446        | Grouped    | 0                   |
| Service-Identifier               | 439        | Unsigned32 |                     |
| Rating-Group                     | 432        | Unsigned32 |                     |

**CCR-I**

```
CCR (Sequence: 272, Seq)
├─ Session-Id: "pgw_c.example.com;123;456;gy"
├─ Auth-Application-Id: 4
├─ Origin-Host: "omni-pgw_c.epc.mnc999.mcc999.3gppnetwork.org"
├─ Origin-Realm: "epc.mnc999.mcc999.3gppnetwork.org"
├─ Destination-Realm: "epc.mnc999.mcc999.3gppnetwork.org"
├─ CC-Request-Type: INITIAL_REQUEST (1)
├─ CC-Request-Number: 0
├─ Subscription-Id (Grouped)
│ ├─ Subscription-Id-Type: END_USER_IMSI (1)
│ └─ Subscription-Id-Data: "310260123456789"
├─ Subscription-Id (Grouped)
│ ├─ Subscription-Id-Type: END_USER_E164 (0)
│ └─ Subscription-Id-Data: "15551234567"
├─ Service-Context-Id: "32251@3gpp.org"
├─ Multiple-Services-Credit-Control (Grouped)
│ ├─ Service-Identifier: 1
│ ├─ Rating-Group: 100
│ └─ Requested-Service-Unit (Grouped)
│ └─ CC-Total-Octets: 10000000 (10 MB)
└─ Used-Service-Unit (Grouped)
 └─ CC-Total-Octets: 0 (0)
```

## CCA-Initial - Seq

Seq OCS-CCR-I

Seq

- Seq
- Seq
- Seq

PGW-C-Seq-AVP

| AVP名                             | AVP番号 | 内容          |
|----------------------------------|-------|-------------|
| Result-Code                      | 268   | 2001 (成功)   |
| Multiple-Services-Credit-Control | 456   | クレジットコントロール |
| Granted-Service-Unit             | 431   | サービスユニット    |
| Validity-Time                    | 448   | 有効時間        |
| Result-Code                      | 268   | 成功          |
| Final-Unit-Indication            | 430   | 最終サービスユニット  |
| Volume-Quota-Threshold           | -     | 体積クォータ閾値    |

例

```

CCA (AVP番号: 272, 内容)
├─ Session-Id: "pgw_c.example.com;123;456;gy"
├─ Result-Code: DIAMETER_SUCCESS (2001)
├─ Origin-Host: "ocs.example.com"
├─ Origin-Realm: "example.com"
├─ Auth-Application-Id: 4
├─ CC-Request-Type: INITIAL_REQUEST (1)
├─ CC-Request-Number: 0
├─ Multiple-Services-Credit-Control (Grouped)
│ ├─ Result-Code: DIAMETER_SUCCESS (2001)
│ ├─ Service-Identifier: 1
│ ├─ Rating-Group: 100
│ └─ Granted-Service-Unit (Grouped)
│ └─ CC-Total-Octets: 10000000 (約10 MB)
├─ Validity-Time: 3600 (1時間)
└─ Volume-Quota-Threshold: 8000000 (約8 MBの80%)

```

## CCR-Update (更新) - 例

例

- 80%
- 
- 
- 

- 
- 
- 

### CCR-I

- CC-Request-Type: UPDATE\_REQUEST (2)
- CC-Request-Number
- Used-Service-Unit
- Requested-Service-Unit

### CCR-U

```

CCR (: 272,)
├─ Session-Id: "pgw_c.example.com;123;456;gy"
├─ Auth-Application-Id: 4
├─ Origin-Host: "omni-pgw_c.epc.mnc999.mcc999.3gppnetwork.org"
├─ Origin-Realm: "epc.mnc999.mcc999.3gppnetwork.org"
├─ Destination-Realm: "epc.mnc999.mcc999.3gppnetwork.org"
├─ CC-Request-Type: UPDATE_REQUEST (2)
├─ CC-Request-Number: 1
└─ Multiple-Services-Credit-Control (Grouped)
 ├─ Service-Identifier: 1
 ├─ Rating-Group: 100
 ├─ Used-Service-Unit (Grouped)
 │ └─ CC-Total-Octets: 8000000 (8 MB)
 └─ Requested-Service-Unit (Grouped)
 └─ CC-Total-Octets: 10000000 (10 MB)

```

# CCA-Update

OCS CCR-U

- 
- 
- 

## 1.

```
CCA (00)
└─ Multiple-Services-Credit-Control
 └─ Result-Code: DIAMETER_SUCCESS (2001)
 └─ Granted-Service-Unit
 └─ CC-Total-Octets: 10000000 (10 MB)
 └─ Validity-Time: 3600
```

## 2.

```
CCA (00)
└─ Multiple-Services-Credit-Control
 └─ Result-Code: DIAMETER_SUCCESS (2001)
 └─ Granted-Service-Unit
 └─ CC-Total-Octets: 1000000 (1 MB)
 └─ Final-Unit-Indication
 └─ Final-Unit-Action: TERMINATE (0)
```

## 3.

CCA (00)

└─ Result-Code: DIAMETER\_CREDIT\_LIMIT\_REACHED (4012)

└─ Multiple-Services-Credit-Control

└─ Result-Code: DIAMETER\_CREDIT\_LIMIT\_REACHED (4012)

└─ Final-Unit-Indication

└─ Final-Unit-Action: TERMINATE (0)

## CCR-Termination 00000000 - 0000

0000

- UE 00
- PDN 0000
- 0000000000

0000

- 00000000
- 00Gy/Ro 00
- 0000

000000

- CC-Request-Type: TERMINATION\_REQUEST (3)
- Used-Service-Unit 00000000
- Requested-Service-Unit 00000000
- Termination-Cause

00 CCR-T 0000

```
CCR (消息ID: 272, 消息)
├─ Session-Id: "pgw_c.example.com;123;456;gy"
├─ Auth-Application-Id: 4
├─ Origin-Host: "omni-pgw_c.epc.mnc999.mcc999.3gppnetwork.org"
├─ Origin-Realm: "epc.mnc999.mcc999.3gppnetwork.org"
├─ Destination-Realm: "epc.mnc999.mcc999.3gppnetwork.org"
├─ CC-Request-Type: TERMINATION_REQUEST (3)
├─ CC-Request-Number: 5
├─ Termination-Cause: DIAMETER_LOGOUT (1)
└─ Multiple-Services-Credit-Control (Grouped)
 ├─ Service-Identifier: 1
 ├─ Rating-Group: 100
 └─ Used-Service-Unit (Grouped)
 └─ CC-Total-Octets: 18500000 (消息18.5 MB)
```

## CCA-Termination消息 - 消息

消息 OCS消息CCR-T

消息

- 消息
- 消息
- 消息

消息CCA-T

```
CCA (消息ID: 272, 消息)
├─ Session-Id: "pgw_c.example.com;123;456;gy"
├─ Result-Code: DIAMETER_SUCCESS (2001)
├─ Origin-Host: "ocs.example.com"
├─ Origin-Realm: "example.com"
├─ Auth-Application-Id: 4
├─ CC-Request-Type: TERMINATION_REQUEST (3)
└─ CC-Request-Number: 5
```

□□□□□□

□□□□□□

OCS□□□□□□□□□□

| □□□□       | AVP                               | □□             | □□              |
|------------|-----------------------------------|----------------|-----------------|
| □□         | CC-Time                           | □              | □□□□□□□□□□<br>□ |
| □□         | CC-Total-Octets                   | □□□□□□+□<br>□□ | □□□□            |
| □□□□<br>□□ | CC-Input-Octets, CC-Output-Octets | □□□□□□         | □□□□□           |
| □□□□       | CC-Service-Specific-Units         | □□□□□          | □□□□□□API□□     |
| □□         | -                                 | □□□□           | □□□□□□□         |

□□□□□□

□□ PGW-C□□□□□□□□□□□□

□□□□ OCS□□**Volume-Quota-Threshold**□**Time-Quota-Threshold**□PGW-C□□  
PGW-U□PFCP□□□□□□□□□□□□PFCP□□□□

□□□□□

1. OCS 10 MB 80% 8 MB
2. PGW-C PGW-U PFCP
3. 8 MB
  - PGW-C CCR-Update
  -
4. OCS
5. CCR-Update
  - PGW-C

Granted-Service-Unit: 10000000 10 MB  
 Volume-Quota-Threshold: 8000000 8 MB

8 MB → CCR-Update  
 2 MB OCS

### PGW-C

PGW-C PGW-U PFCP

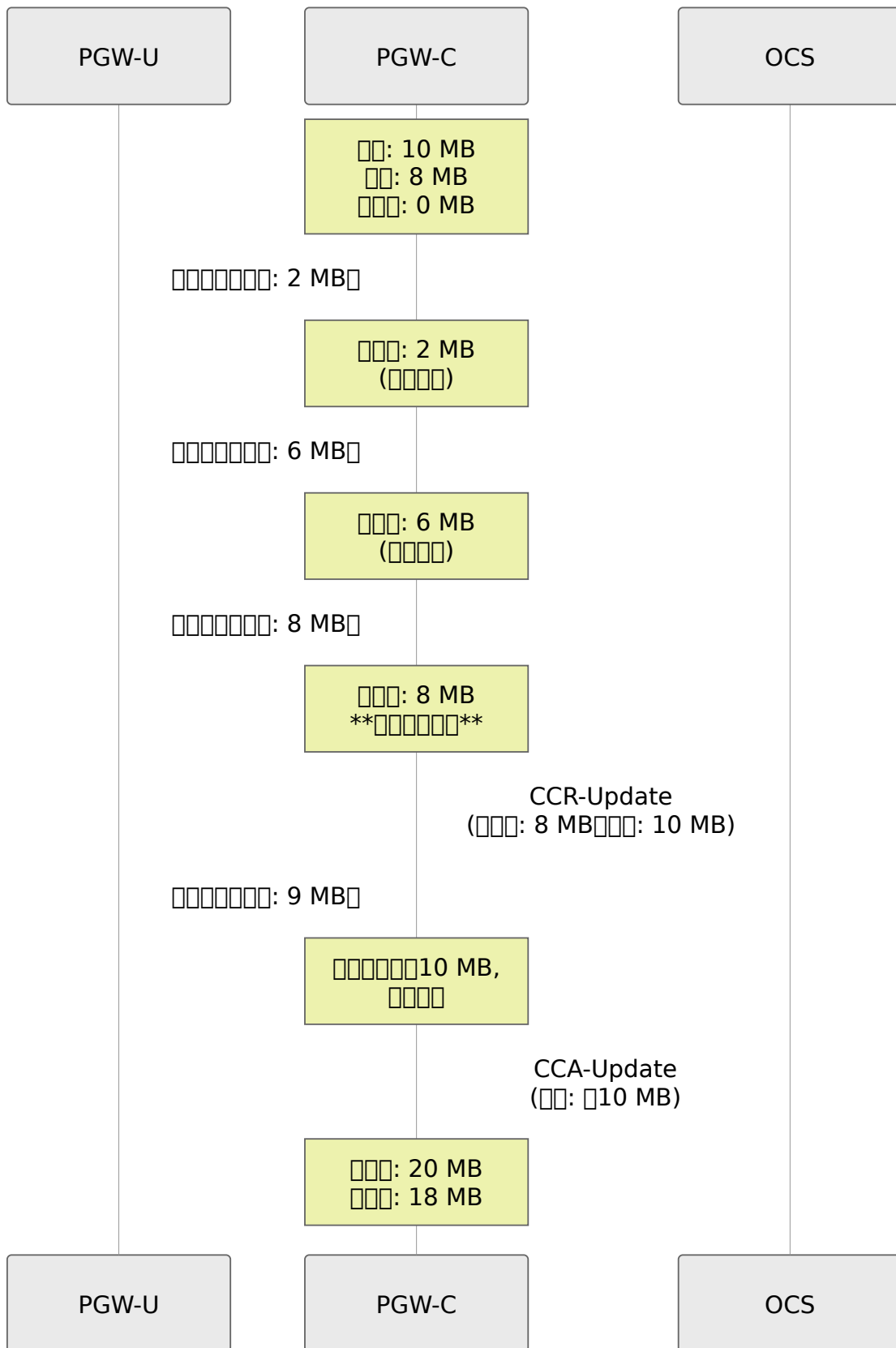

000000

000000000000

## OCS CCA Final-Unit-Indication AVP

| Final-Unit-Action |   | PGW-C |
|-------------------|---|-------|
| TERMINATE         | 0 |       |
| REDIRECT          | 1 |       |
| RESTRICT_ACCESS   | 2 |       |

CCA ( )

```
└─ Multiple-Services-Credit-Control
 └─ Result-Code: DIAMETER_SUCCESS (2001)
 └─ Granted-Service-Unit
 └─ CC-Total-Octets: 1000000 (1 MB)
 └─ Final-Unit-Indication
 └─ Final-Unit-Action: REDIRECT (1)
 └─ Redirect-Server (Grouped)
 └─ Redirect-Address-Type: URL (2)
 └─ Redirect-Server-Address:
 "http://topup.example.com"
```

## PGW-C

- TERMINATE:** CCR-T
- REDIRECT:** PFCP HTTP URL
- RESTRICT\_ACCESS:** PFCP IP

3GPP TS 23.203, TS 29.212, TS 32.251

□□□□PCR□□Gx□□□□**PCC**□□□□□□□□PCC□□□□□□□□Gx□□□

□□□□□□

□□□□□□

PGW-C□□CCR-I□PCRF

PCRF□□PCC□□

PCC□□□□  
□□□□  
□□□

□PCC□□□□  
□□□

□□□□□□□□

PGW-C□□CCR-I  
□OCS

□□□□  
□□□

OCS  
□□□

□□□□ □□□□

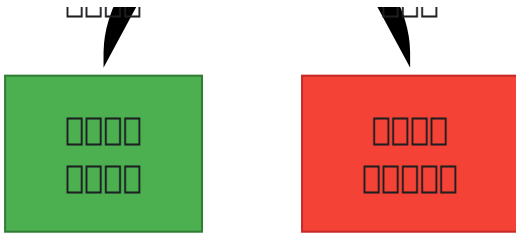

□□□□□□□**PCC**□□

**PCRF**□□□**Gx**□□**CCA-I**□□

```

CCA (Gx□□)
├─ Charging-Rule-Definition (Grouped)
│ ├── Charging-Rule-Name: "prepaid_data_rule"
│ ├── Rating-Group: 100
│ ├── Online: 1 (□□□□□□)
│ ├── Offline: 0 (□□□□□□)
│ ├── Metering-Method: VOLUME (1)
│ ├── Precedence: 100
│ ├── Flow-Information: [...]
│ └─ QoS-Information: [...]

```

**PCC**□□□□□□□□**AVP**□

| AVP                    | AVP  |            |      |
|------------------------|------|------------|------|
| <b>Rating-Group</b>    | 432  | Unsigned32 | OCSS |
| <b>Online</b>          | 1009 | 0=, 1=     | Gy   |
| <b>Offline</b>         | 1008 | 0=, 1=     | Gz   |
| <b>Metering-Method</b> | 1007 | 0=, 1=, 2= |      |
| <b>Reporting-Level</b> | 1011 | 0=, 1=     |      |

|   |   | <b>Rating-Group</b> |  |
|---|---|---------------------|--|
| 1 | 0 |                     |  |
| 0 | 1 |                     |  |
| 1 | 1 |                     |  |
| 0 | 0 | -                   |  |

PDN

```
□□□□□□□□
├─ Rating-Group: 100□□□□□□
└─ Online: 1
```

```
□□□□1□□□□□
├─ Rating-Group: 200□□□□□□
└─ Online: 1
```

```
□□□□2□IMS□□□
├─ Rating-Group: 300□□□□
└─ Online: 1
```

## PGW-C Gy□□□

- □□CCR-I□□□□□MSCC□□□□□□□□□□□□

```
CCR-Initial
├─ Session-Id: "..."
└─ Multiple-Services-Credit-Control
 ├── [Rating-Group: 100] → □□□□
 ├── [Rating-Group: 200] → □□□□
 └─ [Rating-Group: 300] → □□
```

## OCS□□□

```
CCA-Initial
└─ Multiple-Services-Credit-Control
 ├── [Rating-Group: 100] → □□: 10 MB
 ├── [Rating-Group: 200] → □□: 5 MB□□□□□□
 └─ [Rating-Group: 300] → □□: 60□
```

```
□□□□□□□□
```

## PGW-C□□□□□□□□□□

```
[][]
state.charging_quotas = %{
 100 => %{granted: 10_000_000, used: 0, threshold: 8_000_000},
 200 => %{granted: 5_000_000, used: 0, threshold: 4_000_000},
 300 => %{granted: 60_000, used: 0, threshold: 48_000} # []
}
```

[][][][][][][]

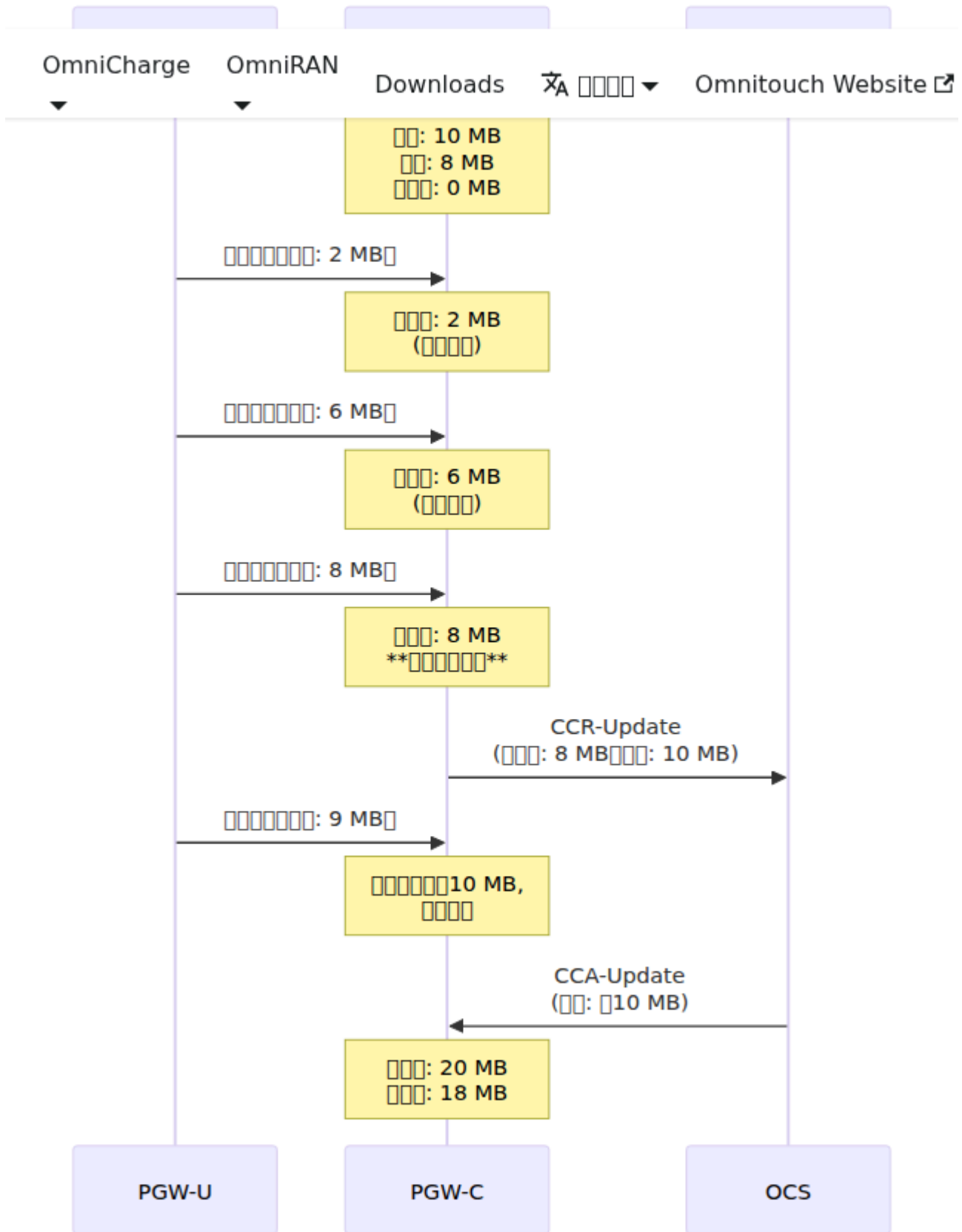

□□□□□□□□

## MSCC□□□□□□□□AVP

□□□ □□□□□/□□□□□□□□□□



```
Multiple-Services-Credit-Control (Grouped, AVP 456)
├─ Service-Identifier (Unsigned32, AVP 439)
├─ Rating-Group (Unsigned32, AVP 432)
├─ Requested-Service-Unit (Grouped, AVP 437)
│ ├─ CC-Time (Unsigned32, AVP 420)
│ ├─ CC-Total-Octets (Unsigned64, AVP 421)
│ ├─ CC-Input-Octets (Unsigned64, AVP 412)
│ └─ CC-Output-Octets (Unsigned64, AVP 414)
├─ Used-Service-Unit (Grouped, AVP 446)
│ └─ [□Requested-Service-Unit□□□□□]
├─ Granted-Service-Unit (Grouped, AVP 431)
│ └─ [□Requested-Service-Unit□□□□□]
├─ Validity-Time (Unsigned32, AVP 448)
├─ Result-Code (Unsigned32, AVP 268)
└─ Final-Unit-Indication (Grouped, AVP 430)
 └─ Final-Unit-Action (Enumerated, AVP 449)
```

# Table Headers

| Item   | Description          | Price             |
|--------|----------------------|-------------------|
| Item 1 | Description 1        | Price 1           |
| Item 2 | 1=Item 2=Item 3=Item | 100=Item 200=Item |
| Item 3 | Description 3        | Price 3           |
| Item 4 | Description 4        | Price 4           |
| Item 5 | Description 5        | Price 5           |
| Item 6 | Description 6 RG     | OCS Description   |

Text

```
Service-Identifier: 100000000
├─ Rating-Group: 100000000 - $0.01/MB
└─ Rating-Group: 200000000 - $0.05/MB

Service-Identifier: 200000000
└─ Rating-Group: 300000000 - $0.10/MB
```

Text

**Gy**

config/runtime.exs

```

config :pgw_c,
 gy: %{
 #
 enabled: true,

 # OCS
 timeout_ms: 5000,

 # PCRF
 default_requested_quota: 10_000_000, # 10 MB

 #
 # (0.8 = 80% CCR-Update)
 quota_threshold_percentage: 0.8,

 # OCS
 # : :block, :allow
 timeout_action: :block,

 # OCS
 # : :terminate, :redirect
 no_credit_action: :terminate,

 # URL no_credit_action: :redirect
 topup_redirect_url: "http://topup.example.com"
 },
 diameter: %{
 listen_ip: "0.0.0.0",
 host: "omni-pgw_c.epc.mnc999.mcc999.3gppnetwork.org",
 realm: "epc.mnc999.mcc999.3gppnetwork.org",

 # OCS
 peer_list: [
 # PCRF Gx
 %{
 host: "pcrf.epc.mnc999.mcc999.3gppnetwork.org",
 realm: "epc.mnc999.mcc999.3gppnetwork.org",
 ip: "10.0.0.30",
 initiate_connection: true
 },
 # OCS Gy
 %{
 host: "ocs.epc.mnc999.mcc999.3gppnetwork.org",

```

```

 realm: "epc.mnc999.mcc999.3gppnetwork.org",
 ip: "10.0.0.40",
 initiate_connection: true
 }
]
}

```

## □□□□□□

### enabled

- `true` □□□□□□□□□□ CCR □□□□ OCS
- `false` □□□□□□□□□□ Gy □□

### timeout\_ms

- □□ OCS □ CCA □□□□
- □□□ 3000-5000 ms

### default\_requested\_quota

- □□ PCRF □□□□□□□□□□
- □□□□ 1-100 MB

### quota\_threshold\_percentage

- □□□□□□□□□□ CCR-Update
- □□□ 0.75-0.85 □ 75%-85% □
- □□ = □□□□□□□□□□□□
- □□ = □□□□□□□□□□

### timeout\_action

- `:block` - □□ OCS □□□□□□□□□□□□□□□□□□
- `:allow` - □□ OCS □□□□□□□□□□□□□□□□□□

### no\_credit\_action

- `:terminate` - □□□□□□□□□□

- `:redirect` - 00000000

00000000

000000000000

```
config :pgw_c,
 gy: %{\br/> enabled: true,
 timeout_action: :block,
 no_credit_action: :terminate,
 quota_threshold_percentage: 0.8
 }
```

00/000

```
config :pgw_c,
 gy: %{\br/> enabled: false # 0000
 }
```

0000000000000000

```
config :pgw_c,
 gy: %{\br/> enabled: true, # 0PCRF000000
 timeout_action: :allow, # 0CS000000000
 no_credit_action: :terminate
 }
```

---

□□□□

□□□□□□□□

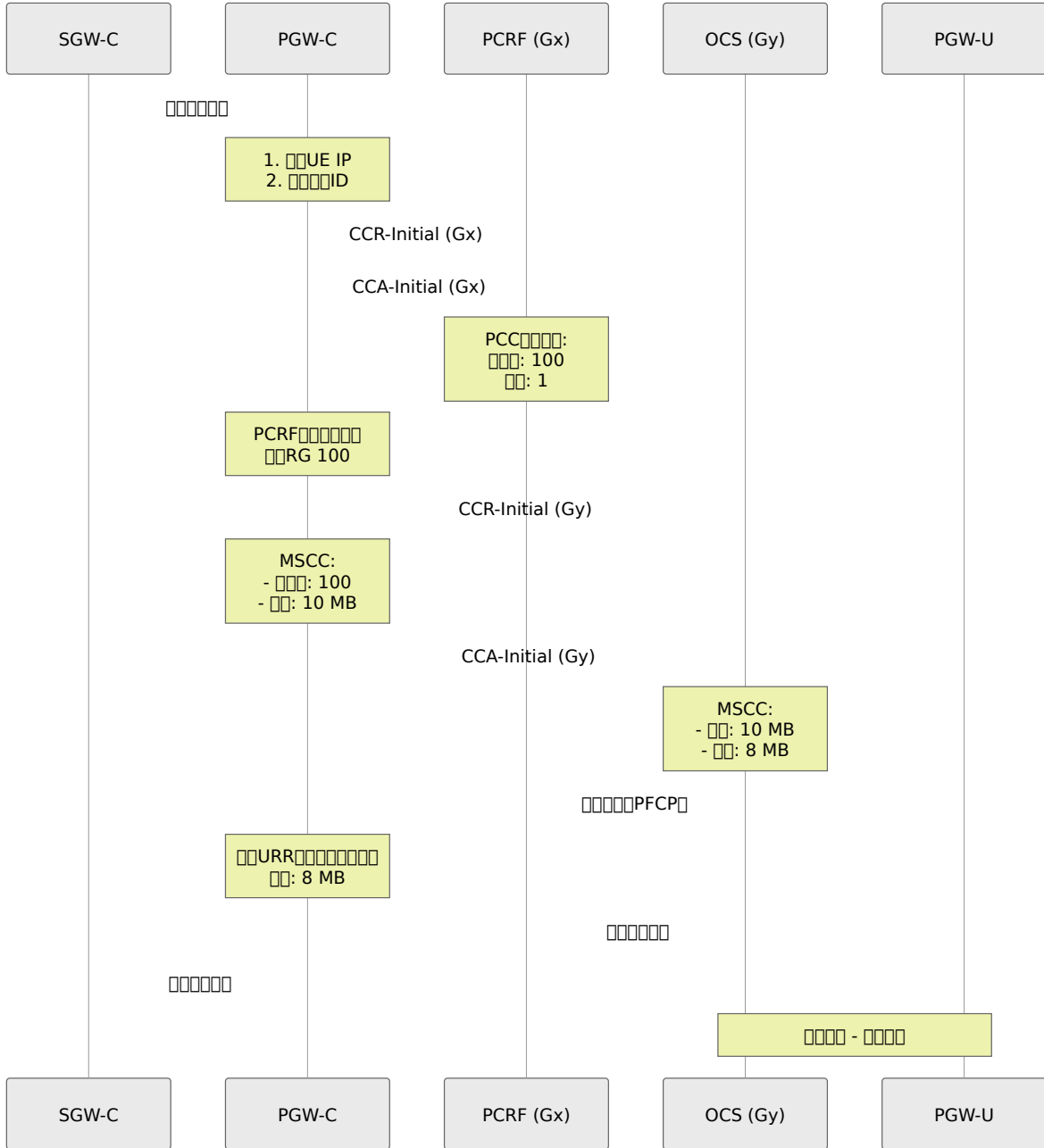

□□□□□□ **CCR-Update** □

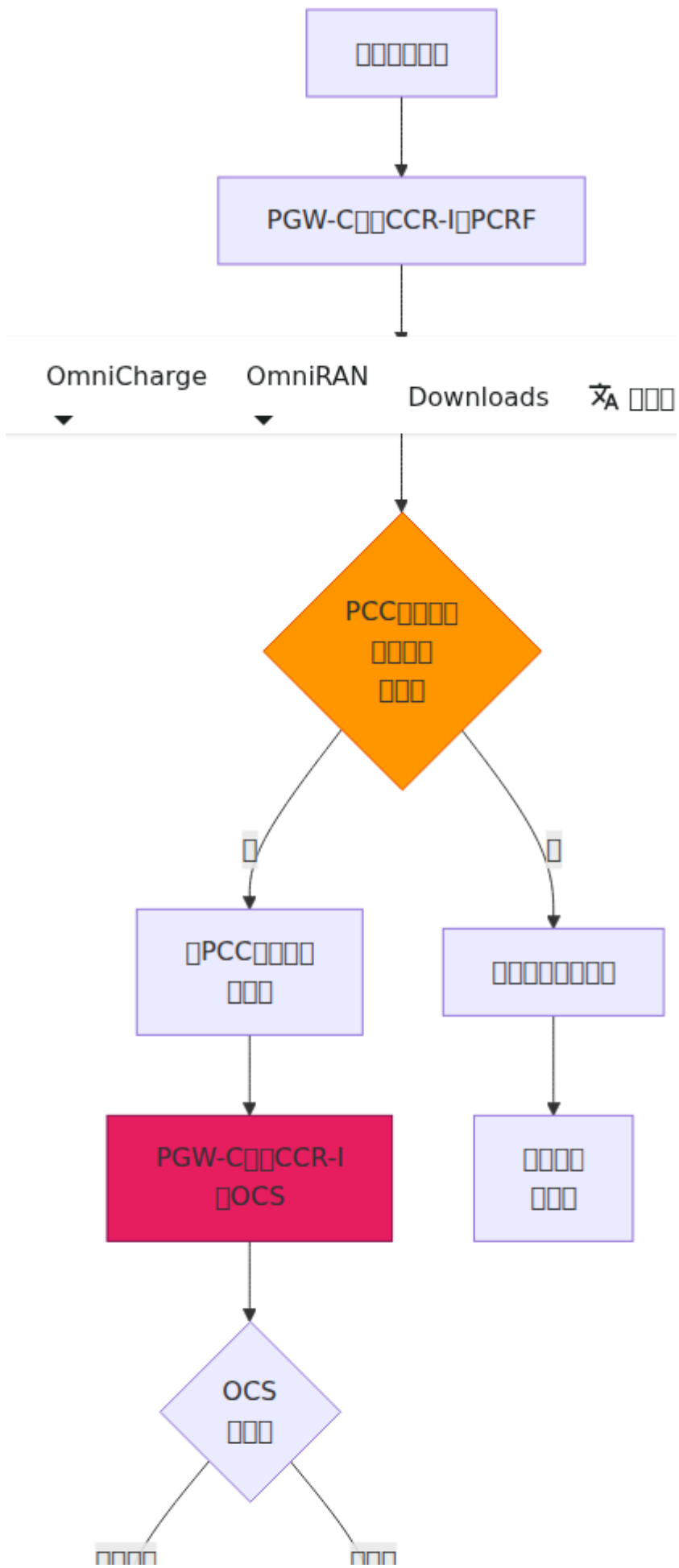

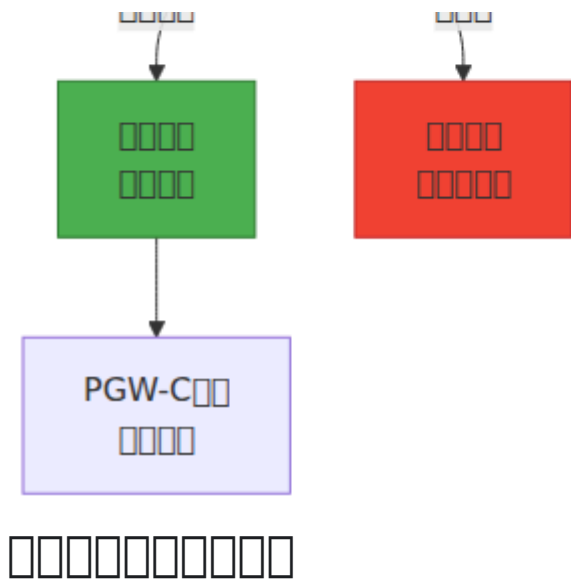

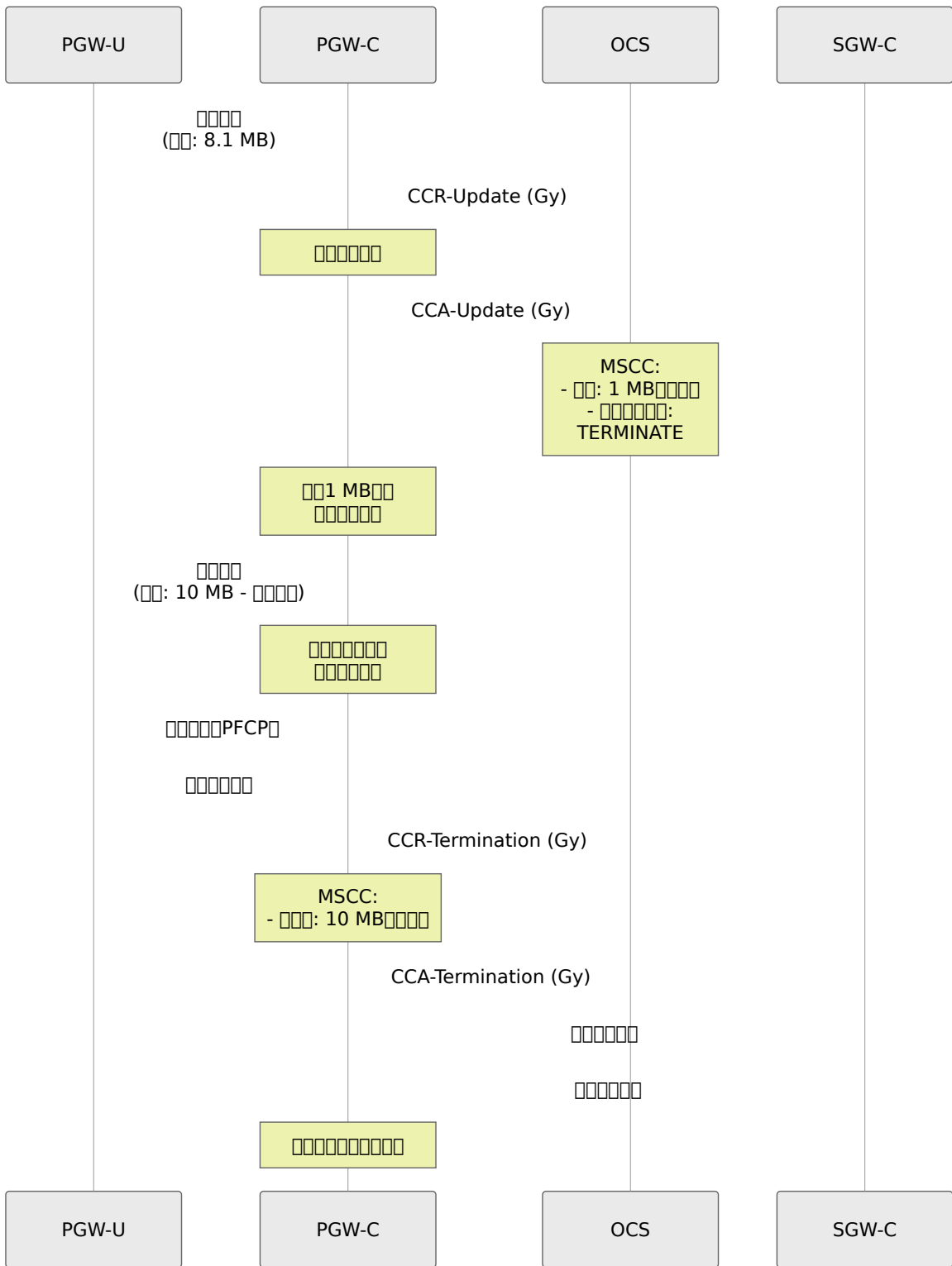

# OCS

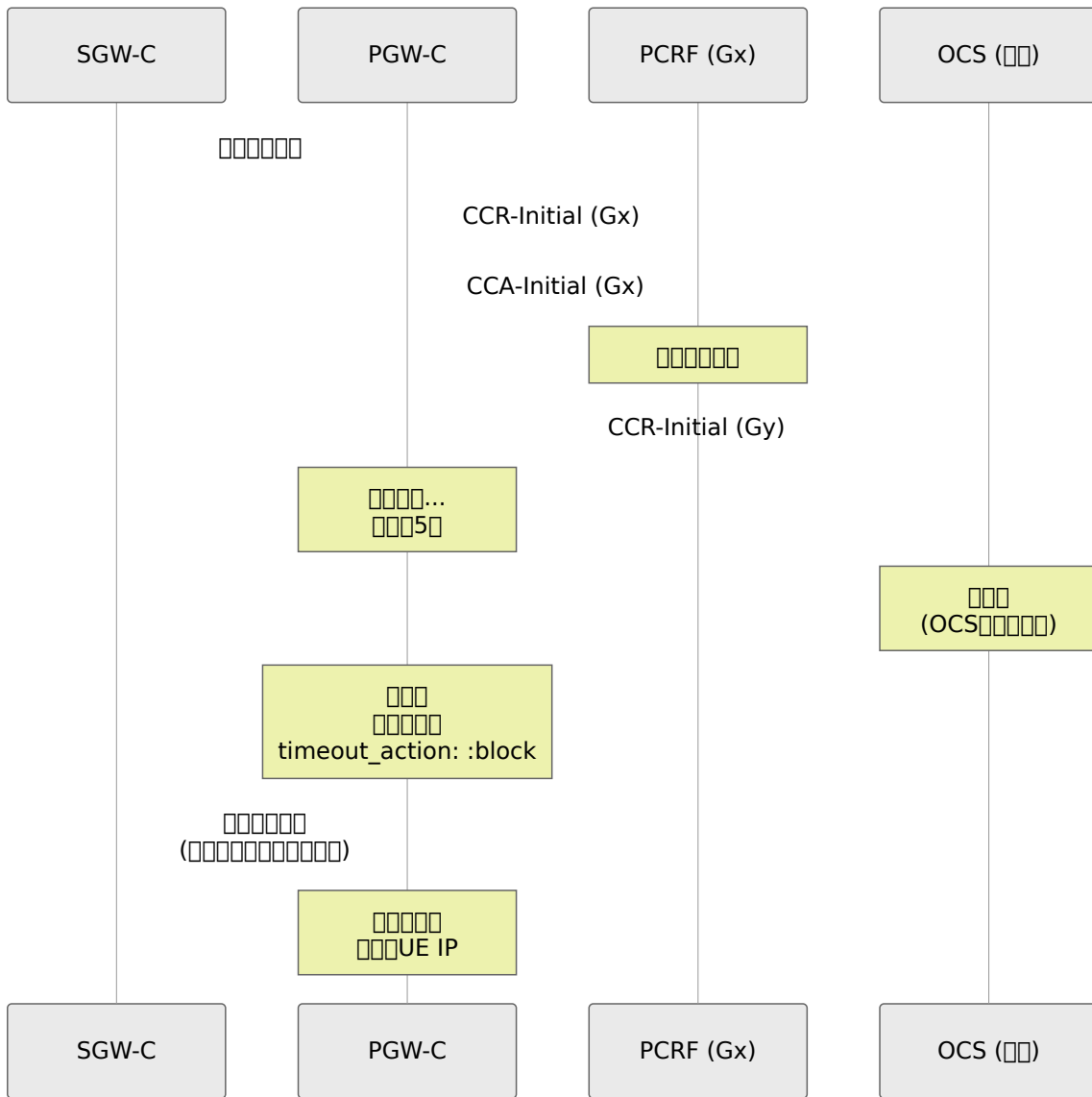

□□□□

□□□□

□□□□

| Code | Message          | Severity    |
|------|------------------|-------------|
| 2001 | DIAMETER_SUCCESS | Information |

4xxx

| Code | Message                       | PGW-C       |
|------|-------------------------------|-------------|
| 4010 | DIAMETER_TOO_BUSY             | Information |
| 4011 | DIAMETER_UNABLE_TO_COMPLY     | Information |
| 4012 | DIAMETER_CREDIT_LIMIT_REACHED | Information |

5xxx

| Code | Message                         | PGW-C       |
|------|---------------------------------|-------------|
| 5003 | DIAMETER_AUTHORIZATION_REJECTED | Information |
| 5031 | DIAMETER_USER_UNKNOWN           | Information |

Result-Code

Result-Code

1. -
2. **MSCC** -

CCA-Initial

└─ Result-Code: DIAMETER\_SUCCESS (2001) ← OK

└─ Multiple-Services-Credit-Control

└─ [Rating-Group: 100]

└─ Result-Code: DIAMETER\_SUCCESS (2001) ← RG 100 OK

└─ [Rating-Group: 200]

└─ Result-Code: DIAMETER\_CREDIT\_LIMIT\_REACHED (4012) ←

RG 200

## PGW-C

- 100
- 200

## Gx

Gx PCRF  Gy 

# Gx Gy

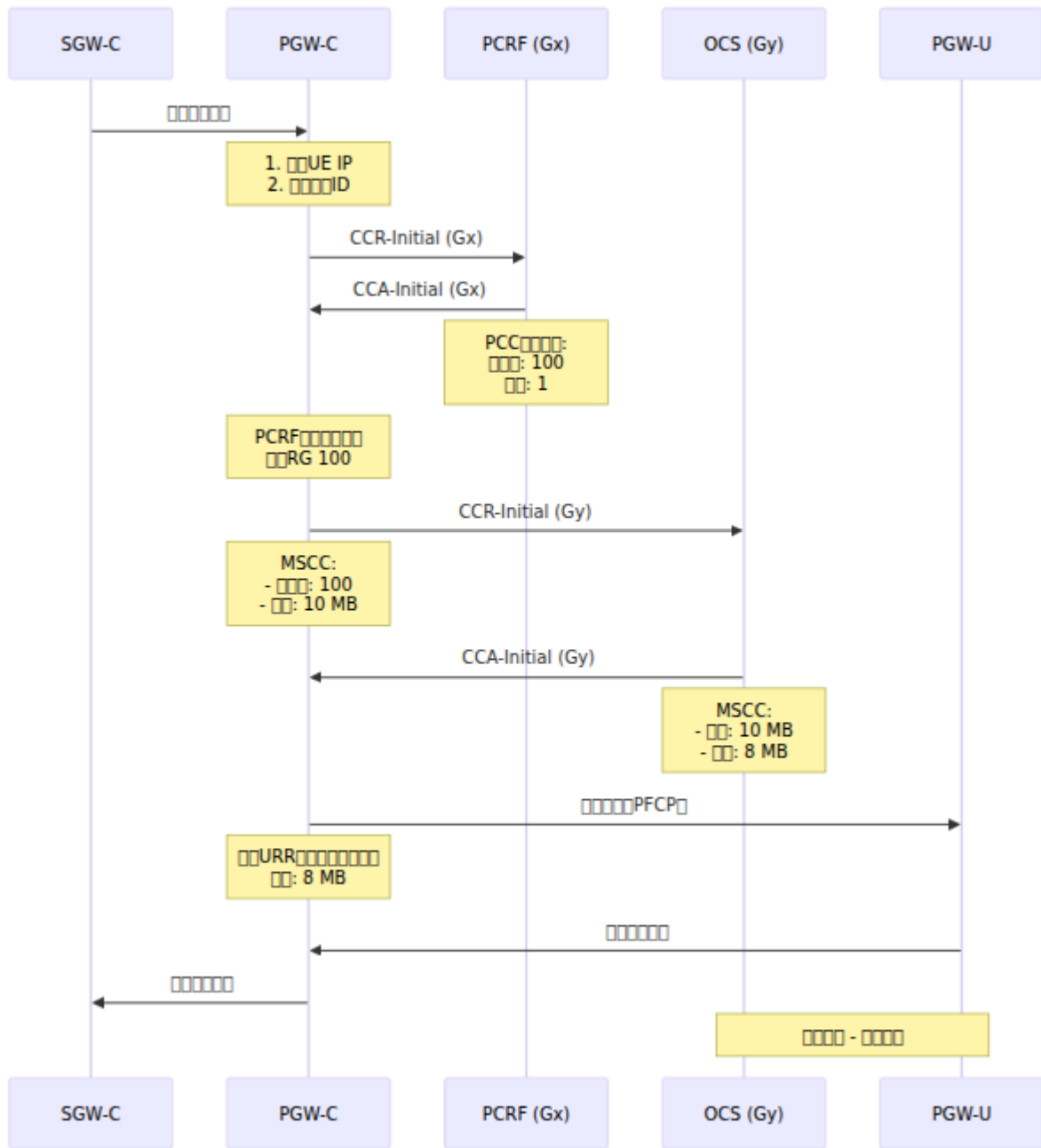

1. 1. 1. 1.

1. 1. 1. 1.

PGW-C□□□□□□□□

↓

□□CCR-I□PCRFGx□

↓

□□CCA-I□PCC□□

↓

□□PCC□□□

- □□□□□□□□

- □□=1□

↓

□□□□

□□CCR-I□OCS□Gy□□□□□

↓

□□CCA-I□□□

↓

□□□□□□□□

□□□□□□□□

□□□□

□□□□□□□□

## 2. □□□□□□PCRFGxRAR□

PCRFGx□□□RAR□□□□□□□□

↓

□□PCC□□□□□=1□□□□=200

↓

PGW-C□□CCR-U□OCS□Gy□

- □□□□200□□MSCC

↓

OCS□□□□□□□□

↓

□□□□□□□□□□

□□□□

□□□□

## 1. CCR-Initial□OCS□□

□□□

- □□□□□□“OCS□□”
- □□□“CCR-Initial□Gy□□□”

□□□□□

- OCS□□□
- □□□□OCS IP□□□
- □□□□□□□□□□3868□
- OCS□□

□□□□□

```
□□□□□□
ping <ocs_ip>

□□□□□□□□TCP 3868□
telnet <ocs_ip> 3868

□□□□
□□□peer_list□□□□□OCS□□□□
```

## 2. □□□OCS□□

□□□

- CCA-I□Result-Code != 2001
- □□□□□□□□

□□□□□□□

| Code | Category   | Item         |
|------|------------|--------------|
| 4012 | Category 1 | Item 1       |
| 5003 | Category 2 | Item 2       |
| 5031 | Category 3 | Item 3 (OCS) |

Section 1

- Item 1 (OCS)
- Item 2 (OCS)
- Item 3 (CCR-I/IMSI/MSISDN)

### 3. Section 3

Section 4

- Item 1
- Item 2 (CCR-Update)

Section 5

- Item 1 (PGW-U/URR)
- Item 2
- Item 3 (PFCP)

Section 6

- Item 1 (PFCP/URR)

```

URR
├─ URR-ID: 1
├─ Measurement-Method: VOLUME
├─ Volume-Threshold: 8000000 8 MB
└─ Reporting-Triggers: VOLUME_THRESHOLD

```

- Item 2 (PGW-U)

3. `quota_threshold_percentage`

#### 4. `quota`

`quota`

- OCS `quota` “`quota`”
- `quota`

`quota`

- CCR-I `quota` OCS `quota`
- PCRf `quota`

`quota`

1. `PCRf` `PCC` `quota`
  2. `OCS` `quota`
  3. `PCC` `OCS` `quota`
-

□□

□□□□

```
Gy□□□□
rate(gy_inbound_messages_total{message_type="cca"}[5m])
rate(gy_outbound_messages_total{message_type="ccr"}[5m])

Gy□□□□
rate(gy_inbound_errors_total[5m])

□□□□□□
rate(gy_quota_exhausted_total[5m])

OCS□□□
rate(gy_timeout_total[5m])

Gy□□□□□□□□
histogram_quantile(0.95,
rate(gy_inbound_handling_duration_bucket[5m]))
```

□□

```
GyErrorRateHigh
- alert: GyErrorRateHigh
 expr: rate(gy_inbound_errors_total[5m]) > 0.1
 for: 5m
 annotations:
 summary: "GyErrorRateHigh"

OcsTimeout
- alert: OcsTimeout
 expr: rate(gy_timeout_total[5m]) > 0.05
 for: 2m
 annotations:
 summary: "OcsTimeout"

GyQuotaExhaustionSpike
- alert: CreditExhaustionSpike
 expr: rate(gy_quota_exhausted_total[5m]) > 10
 for: 5m
 annotations:
 summary: "CreditExhaustionSpike"
```

---

## Web UI - GyErrorRateHigh

OmniPGW GyErrorRateHigh/RoamingChargingControl/ChargingControl/OCS

□□ [http://<omnipgw-ip>:<web-port>/gy\\_simulator](http://<omnipgw-ip>:<web-port>/gy_simulator)



- IMSI - MSISDN
- IMSI - IMSI

## IMS

1. IMSI/MSISDN
2. IMSI/MSISDN 1000000000 1 MB
3. IMSI/MSISDN
4. IMSI/MSISDN "CCR-I"
5. IMSI/MSISDN

## IMS

- IMSI/MSISDN OCS
- IMSI/MSISDN
- IMSI/MSISDN
- IMSI/MSISDN

## IMS

## IMS

- **Gx** - PCRF IMSI/MSISDN PCC
- **CDR** - IMSI/MSISDN
- **IMS** - IMSI/MSISDN

## IMS

- **IMS** - PDN IMSI/MSISDN
- **PFCP** - IMSI/MSISDN URR PGW-U IMSI/MSISDN
- **S5/S8** - GTP-C IMSI/MSISDN

□□

- □□□□ - Gy□□□□□□□□□□OCS□□□□
  - **UE IP**□□ - □□□□□□IP□□□□
- 

□□□□□□

# OmniPGW 部署架构图

Prometheus 部署图

OmniTouch 部署图

---

## 部署

1. 部署
  2. 部署
  3. 部署
  4. Prometheus 部署
  5. Grafana 部署
  6. 部署
  7. 部署
  8. 部署
- 

## 部署

OmniPGW 部署图

### 1. Web UI 部署图

- 部署
- PFCP 部署
- Diameter 部署
- 部署

### 2. Prometheus 部署图

- 部署
- 部署

- `prometheus`
- `node_exporter`

OmniPGW Prometheus Web UI

- `node_exporter` - Web UI
- `PFCP` - Web UI
- `Diameter Gx` - Web UI

## Prometheus

OmniPGW Prometheus

- `node_exporter` - Prometheus
- `PFCP` - Prometheus
- `Diameter Gx` - Prometheus
- `node_exporter` - Prometheus
- `PFCP` - Prometheus

Diagram

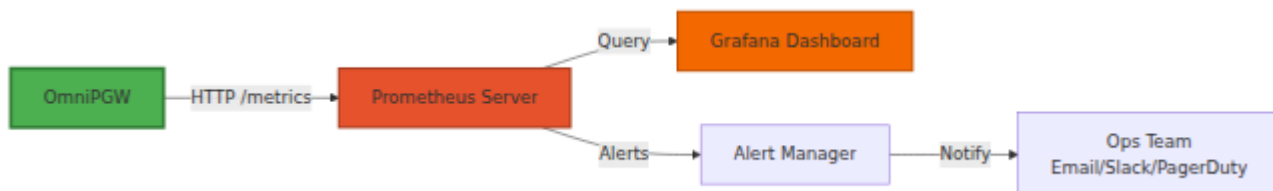

Diagram

Code

`config/runtime.exs`

```
config :pgw_c,
 metrics: %{
 enabled: true,
 ip_address: "0.0.0.0", # 0.0.0.0
 port: 9090, # HTTP 9090
 registry_poll_period_ms: 5_000 # 5000
 }
```

0000

**HTTP** 000

```
http://<omnipgw_ip>:<port>/metrics
```

000

```
curl http://10.0.0.20:9090/metrics
```

0000

000 **Prometheus** 0000 000

```
HELP teid_registry_count The number of TEID registered to
sessions
TYPE teid_registry_count gauge
teid_registry_count 150

HELP address_registry_count The number of addresses registered
to sessions
TYPE address_registry_count gauge
address_registry_count 150

HELP s5s8_inbound_messages_total The total number of messages
received from S5/S8 peers
TYPE s5s8_inbound_messages_total counter
s5s8_inbound_messages_total{message_type="create_session_request"}
1523
s5s8_inbound_messages_total{message_type="delete_session_request"}
1487
```

---

□□□□

OmniPGW □□□□□□□□

□□□□

□□□□□□

| 메트릭                                 | 유형    | 설명                        |
|-------------------------------------|-------|---------------------------|
| teid_registry_count                 | Gauge | S5/S8 TEID 개수             |
| seid_registry_count                 | Gauge | PFCP SEID 개수              |
| session_id_registry_count           | Gauge | Gx Diameter Session-ID 개수 |
| session_registry_count              | Gauge | IMSI, EBI 개수              |
| address_registry_count              | Gauge | UE IP 개수                  |
| charging_id_registry_count          | Gauge | ID 개수, CDR 개수, CDR 개수     |
| sxb_sequence_number_registry_count  | Gauge | PFCP 개수                   |
| s5s8_sequence_number_registry_count | Gauge | S5/S8 개수                  |
| sxb_peer_registry_count             | Gauge | PFCP 개수                   |

예시

```
기본값
teid_registry_count

5분 평균
rate(teid_registry_count[5m])

1시간 최대값
max_over_time(teid_registry_count[1h])
```

참고

**S5/S8 (GTP-C)** 개수

| 计数器                          | 类型      | 消息类型         | 描述          |
|------------------------------|---------|--------------|-------------|
| s5s8_inbound_messages_total  | Counter | message_type | 5G S5/S8 消息 |
| s5s8_outbound_messages_total | Counter | message_type | 5G S5/S8 消息 |
| s5s8_inbound_errors_total    | Counter | message_type | 5G S5/S8 错误 |

消息类型

- create\_session\_request
- create\_session\_response
- delete\_session\_request
- delete\_session\_response
- create\_bearer\_request
- delete\_bearer\_request

### Sxb (PCF) 计数器

| 计数器                         | 类型      | 消息类型         | 描述     |
|-----------------------------|---------|--------------|--------|
| sxb_inbound_messages_total  | Counter | message_type | PCF 消息 |
| sxb_outbound_messages_total | Counter | message_type | PCF 消息 |
| sxb_inbound_errors_total    | Counter | message_type | PCF 错误 |
| sxb_outbound_errors_total   | Counter | message_type | PCF 错误 |

消息类型

- association\_setup\_request
- association\_setup\_response
- heartbeat\_request

- heartbeat\_response
- session\_establishment\_request
- session\_establishment\_response
- session\_modification\_request
- session\_deletion\_request

## Gx (Diameter) □□□

| <span style="font-family: monospace;">□□□□</span> | <span style="font-family: monospace;">□□</span> | <span style="font-family: monospace;">□□</span>                                             | <span style="font-family: monospace;">□□</span>                                                                                                                                                                                 |
|---------------------------------------------------|-------------------------------------------------|---------------------------------------------------------------------------------------------|---------------------------------------------------------------------------------------------------------------------------------------------------------------------------------------------------------------------------------|
| <code>gx_inbound_messages_total</code>            | Counter                                         | <code>message_type</code>                                                                   | <span style="font-family: monospace;">□□□</span><br>Diameter<br><span style="font-family: monospace;">□□</span>                                                                                                                 |
| <code>gx_outbound_messages_total</code>           | Counter                                         | <code>message_type</code>                                                                   | <span style="font-family: monospace;">□□□</span><br>Diameter<br><span style="font-family: monospace;">□□</span>                                                                                                                 |
| <code>gx_inbound_errors_total</code>              | Counter                                         | <code>message_type</code>                                                                   | Diameter<br><span style="font-family: monospace;">□□□□□□</span>                                                                                                                                                                 |
| <code>gx_outbound_errors_total</code>             | Counter                                         | <code>message_type</code>                                                                   | Diameter<br><span style="font-family: monospace;">□□□□□□</span>                                                                                                                                                                 |
| <code>gx_outbound_responses_total</code>          | Counter                                         | <code>message_type,</code><br><code>result_code_class,</code><br><code>diameter_host</code> | <span style="font-family: monospace;">□□□□□□□□</span><br><span style="font-family: monospace;">□□□□□□□□</span><br><span style="font-family: monospace;">□</span><br>Diameter<br><span style="font-family: monospace;">□□</span> |

## □□□□□

- `gx_CCA` (Credit-Control-Answer)
- `gx_CCR` (Credit-Control-Request)
- `gx_RAA` (Re-Auth-Answer)
- `gx_RAR` (Re-Auth-Request)

golang `gx_outbound_responses_total`

- `2xxx` - 2001 DIAMETER\_SUCCESS
- `3xxx` - 3001 DIAMETER\_COMMAND\_UNSUPPORTED
- `4xxx` - 4001 DIAMETER\_AUTHENTICATION\_REJECTED
- `5xxx` - 5012 DIAMETER\_UNABLE\_TO\_COMPLY

golang

```
Gx 百分比
sum(rate(gx_outbound_responses_total{result_code_class="2xxx"}[5m]))
sum(rate(gx_outbound_responses_total[5m])) * 100

PCRF 百分比
rate(gx_outbound_responses_total{result_code_class!="2xxx"}[5m]) by (

Re-Auth-Answer 百分比
gx_outbound_responses_total{message_type="gx_RAA",result_code_class='

PCRF 异常百分比
rate(gx_outbound_responses_total{result_code_class=~"4xxx|5xxx",diame
[5m]) > 0.1
```

golang

| 名称                         | 类型      | 属性                            | 备注  |
|----------------------------|---------|-------------------------------|-----|
| <code>rescues_total</code> | Counter | <code>module, function</code> | ... |

golang

golang

| 項目名                            | 種類        | 単位                   |                       |
|--------------------------------|-----------|----------------------|-----------------------|
| s5s8_inbound_handling_duration | Histogram | request_message_type | S<br>[<br>[<br>[      |
| sxb_inbound_handling_duration  | Histogram | request_message_type | F<br>[<br>[<br>[      |
| gx_inbound_handling_duration   | Histogram | request_message_type | [<br>[<br>[<br>[<br>[ |

項目名

| 項目名                                | 種類        | 単位                   |  |
|------------------------------------|-----------|----------------------|--|
| s5s8_outbound_transaction_duration | Histogram | request_message_type |  |
| sxb_outbound_transaction_duration  | Histogram | request_message_type |  |
| gx_outbound_transaction_duration   | Histogram | request_message_type |  |

項目名

- 0.0001, 0.0005, 0.001, 0.005, 0.01, 0.05, 0.1, 0.5, 1.0, 5.0
- 100µs, 500µs, 1ms, 5ms, 10ms, 50ms, 100ms, 500ms, 1s, 5s

000

```
95th 000 S5/S8 00
histogram_quantile(0.95,
 rate(s5s8_inbound_handling_duration_bucket[5m])
)

00 PFCP 00
rate(sxb_inbound_handling_duration_sum[5m]) /
rate(sxb_inbound_handling_duration_count[5m])
```

## UPF 0000

### UPF 00000

| 0000                       | 00    | 00      | 00                             |
|----------------------------|-------|---------|--------------------------------|
| upf_peers_total            | Gauge | -       | 000 UPF 0000                   |
| upf_peers_healthy          | Gauge | -       | 000 UPF 00000000 + 0<br>0000   |
| upf_peers_unhealthy        | Gauge | -       | 0000 UPF 0000                  |
| upf_peers_associated       | Gauge | -       | 0000 PFCP 000 UPF 00<br>00     |
| upf_peers_unassociated     | Gauge | -       | 00 PFCP 000 UPF 0000           |
| upf_peer_healthy           | Gauge | peer_ip | 00 UPF 00000001=0000<br>0=0000 |
| upf_peer_missed_heartbeats | Gauge | peer_ip | 00 UPF 0000000000              |

□□□

```
□□ UPF □□□
upf_peers_healthy / upf_peers_total

□□□□□□ UPF □□□□
upf_peers_unhealthy > 0

□□□□ UPF □□
upf_peer_healthy{peer_ip="10.98.0.20"}

□□□□□□□□ UPF
upf_peer_missed_heartbeats > 2
```

□□□□□

```

[] UPF []
- alert: UPF_Peer_Down
 expr: upf_peer_healthy == 0
 for: 1m
 labels:
 severity: critical
 annotations:
 summary: "UPF {{ $labels.peer_ip }} []"
 description: "UPF [] PFCP []"

[] UPF []
- alert: UPF_Pool_Degraded
 expr: (upf_peers_healthy / upf_peers_total) < 0.5
 for: 2m
 labels:
 severity: critical
 annotations:
 summary: "UPF []"
 description: "[] {{ $value | humanizePercentage }} [] UPF []"

[]
- alert: UPF_Heartbeat_Issues
 expr: upf_peer_missed_heartbeats > 2
 for: 30s
 labels:
 severity: warning
 annotations:
 summary: "UPF {{ $labels.peer_ip }} []"
 description: "{{ $value }} []"

```

## P-CSCF []

### P-CSCF []

| メトリック                                | タイプ   | ラベル               | 説明                        |
|--------------------------------------|-------|-------------------|---------------------------|
| <code>pcscf_fqdns_total</code>       | Gauge | -                 | 登録された P-CSCF FQDN の数      |
| <code>pcscf_fqdns_resolved</code>    | Gauge | -                 | DNS 解決された P-CSCF FQDN の数  |
| <code>pcscf_fqdns_failed</code>      | Gauge | -                 | DNS 解決失敗した P-CSCF FQDN の数 |
| <code>pcscf_servers_total</code>     | Gauge | -                 | 登録された P-CSCF サーバの数        |
| <code>pcscf_servers_healthy</code>   | Gauge | <code>fqdn</code> | FQDN ごとに健康な P-CSCF サーバの数  |
| <code>pcscf_servers_unhealthy</code> | Gauge | <code>fqdn</code> | FQDN ごとに不健康な P-CSCF サーバの数 |

健康な P-CSCF サーバの数を監視する IMS サービス

メトリック

ラベル

| メトリック                       | タイプ   | ラベル                        |
|-----------------------------|-------|----------------------------|
| <code>license_status</code> | Gauge | <code>1 = 有効 0 = 無効</code> |

例

```
有効なライセンス
license_status == 1

無効なライセンス
license_status == 0
```

メトリック

```
- alert: PGW_C_License_Invalid
 expr: license_status == 0
 for: 1m
 labels:
 severity: critical
 annotations:
 summary: "PGW-C [redacted]"
 description: "[redacted] - [redacted]"
```

[redacted]

[redacted] GTP-C [redacted] "[redacted]" (73)[redacted]

Wireshark [redacted] "[redacted]"

[redacted]

- [redacted] omnipgwc
- [redacted] URL [redacted] config/runtime.exs [redacted] :license\_client [redacted]
- [redacted] license\_status == 0 [redacted] GTP-C [redacted] 73 [redacted]
- [redacted] UI [redacted]
- Diameter [redacted] GTP-C [redacted] PFCP [redacted]
- [redacted] - [redacted]

□□□□

## Erlang VM □□□

| □□□□                                 | □□    | □□          |
|--------------------------------------|-------|-------------|
| <code>vm_memory_total</code>         | Gauge | □ VM □□□□□□ |
| <code>vm_memory_processes</code>     | Gauge | □□□□□□□□    |
| <code>vm_memory_system</code>        | Gauge | □□□□□□□□    |
| <code>vm_system_process_count</code> | Gauge | □ Erlang □□ |
| <code>vm_system_port_count</code>    | Gauge | □□□□□□      |

# Prometheus □□

□□□□

□ OmniPGW □□□ Prometheus `prometheus.yml` □

```
prometheus.yml
global:
 scrape_interval: 15s
 evaluation_interval: 15s

scrape_configs:
 - job_name: 'omnipgw'
 static_configs:
 - targets: ['10.0.0.20:9090']
 labels:
 instance: 'omnipgw-01'
 environment: 'production'
 site: 'datacenter-1'
```

## OmniPGW

```
scrape_configs:
 - job_name: 'omnipegw'
 static_configs:
 - targets:
 - '10.0.0.20:9090'
 - '10.0.0.21:9090'
 - '10.0.0.22:9090'
 labels:
 environment: 'production'
```

## Kubernetes

```
scrape_configs:
 - job_name: 'omnipegw'
 kubernetes_sd_configs:
 - role: pod
 relabel_configs:
 - source_labels: [__meta_kubernetes_pod_label_app]
 action: keep
 regex: omnipegw
 - source_labels: [__meta_kubernetes_pod_ip]
 target_label: __address__
 replacement: '${1}:9090'
```

```
Prometheus
curl http://prometheus:9090/api/v1/targets

curl 'http://prometheus:9090/api/v1/query?
query=teid_registry_count'
```

---

# Grafana 安装

安装步骤

## 1. 安装 Prometheus 服务

```
curl -L https://github.com/prometheus/prometheus/releases/download/v2.27.1/prometheus-2.27.1.linux-amd64.tar.gz -o prometheus.tar.gz
tar xvfz prometheus.tar.gz
cd prometheus-2.27.1.linux-amd64
cp prometheus prometheus.yml
```

## 2. 配置 Prometheus

配置 Prometheus 的配置文件 prometheus.yml

配置内容

### 配置 1

```
配置名称
teid_registry_count

配置类型 Gauge
配置范围
范围 < 5000
范围 5000-8000
范围 > 8000
```

### 配置 2

```
配置名称
rate(s5s8_inbound_messages_total{message_type="create_session_request"}[5m])

配置类型
配置范围
```

### 3 IP

```
/24 254 IP
(address_registry_count / 254) * 100

Gauge
0-100
#
< 70%
70-85%
> 85%
```

### 4 95th

```
#
histogram_quantile(0.95,

rate(s5s8_inbound_handling_duration_bucket{request_message_type="crea
[5m])
)

#
#
```

### 5

```
#
rate(s5s8_inbound_errors_total[5m])

#
/
> 0.1
```

### 6 Gx

```

2xx Gx 2xx
sum(rate(gx_outbound_responses_total{result_code_class="2xxx"}
[5m])) /
sum(rate(gx_outbound_responses_total[5m])) * 100

2xx Gauge
0-100
#
> 95%
90-95%
< 90%

```

2xx - 2xx

```

2xx
sum(rate(gx_outbound_responses_total[5m])) by (result_code_class)

#
{{ result_code_class }}

```

2xx - 2xx **PCRF** 2xx

```

2xx PCRF 2xx
sum(rate(gx_outbound_responses_total[5m])) by (diameter_host,
result_code_class)

#
{{ diameter_host }} - {{ result_code_class }}

```

2xx **7xxUPF** 2xx

```
健康なピアの割合
(upf_peers_healthy / upf_peers_total) * 100

健康度Gauge
健康度0-100%
健康度
健康度100%
健康度50-99%
健康度< 50%
```

健康度 - 健康度 **UPF** 健康度

```
健康度 UPF 健康度
upf_peer_healthy

健康度Stat
健康度
1 = "UP"健康度
0 = "DOWN"健康度
```

□□□□□□□□

```
{
 "dashboard": {
 "title": "OmniPGW - □□□□",
 "panels": [
 {
 "title": "□□□□",
 "targets": [
 {
 "expr": "teid_registry_count",
 "legendFormat": "□□□□"
 }
],
 "type": "graph"
 },
 {
 "title": "□□□□□□",
 "targets": [
 {
 "expr":
"rate(s5s8_inbound_messages_total{message_type=\"create_session_reque
[5m])",
 "legendFormat": "□□/□"
 }
],
 "type": "graph"
 },
 {
 "title": "IP □□□□",
 "targets": [
 {
 "expr": "(address_registry_count / 254) * 100",
 "legendFormat": "□□□□ %"
 }
],
 "type": "gauge"
 },
 {
 "title": "□□□□□□p95□",
 "targets": [
 {
 "expr": "histogram_quantile(0.95,
```

```
rate(s5s8_inbound_handling_duration_bucket[5m])),
 "legendFormat": "S5/S8 p95"
},
{
 "expr": "histogram_quantile(0.95,
rate(sxb_inbound_handling_duration_bucket[5m])),
 "legendFormat": "PFCP p95"
}
],
"type": "graph"
}
]
}
}
```

---

□□

□□□□

□□ `omnipgw_alerts.yml` □□

```

groups:
- name: omnipgw
 interval: 30s
 rules:
 # []
 - alert: OmniPGW_HighSessionCount
 expr: teid_registry_count > 8000
 for: 5m
 labels:
 severity: warning
 annotations:
 summary: "OmniPGW []"
 description: "{{ $value }} []8000"

 - alert: OmniPGW_SessionCountCritical
 expr: teid_registry_count > 9500
 for: 2m
 labels:
 severity: critical
 annotations:
 summary: "OmniPGW []"
 description: "{{ $value }} []"

 # IP []
 - alert: OmniPGW_IPPoolUtilizationHigh
 expr: (address_registry_count / 254) * 100 > 80
 for: 10m
 labels:
 severity: warning
 annotations:
 summary: "OmniPGW IP []"
 description: "IP [] {{ $value }}% []"

 - alert: OmniPGW_IPPoolExhausted
 expr: address_registry_count >= 254
 for: 1m
 labels:
 severity: critical
 annotations:
 summary: "OmniPGW IP []"
 description: "[] IP"

 # []

```

```

- alert: OmniPGW_HighErrorRate
 expr: rate(s5s8_inbound_errors_total[5m]) > 0.1
 for: 5m
 labels:
 severity: warning
 annotations:
 summary: "OmniPGW S5/S8"
 description: "{{ $value }} % S5/S8"

- alert: OmniPGW_GxErrorRate
 expr: rate(gx_inbound_errors_total[5m]) > 0.05
 for: 5m
 labels:
 severity: warning
 annotations:
 summary: "OmniPGW Gx"
 description: "{{ $value }} % Diameter"

Gx
- alert: OmniPGW_GxResponseFailureRate
 expr: |

sum(rate(gx_outbound_responses_total{result_code_class!="2xxx"}
[5m])) /
 sum(rate(gx_outbound_responses_total[5m])) > 0.1
 for: 5m
 labels:
 severity: warning
 annotations:
 summary: "OmniPGW Gx"
 description: "{{ $value | humanizePercentage }} % Gx
 2xxx"

- alert: OmniPGW_GxPCRFFailures
 expr:
rate(gx_outbound_responses_total{result_code_class=~"4xxx|5xxx"}
[5m]) by (diameter_host) > 0.05
 for: 3m
 labels:
 severity: warning
 annotations:
 summary: "PCRF {{ $labels.diameter_host }}"
 description: "{{ $value }} % PCRF {{
$labels.diameter_host }}"

```

```

UPF [][]
- alert: OmniPGW_UPF_PeerDown
 expr: upf_peer_healthy == 0
 for: 1m
 labels:
 severity: critical
 annotations:
 summary: "UPF [] {{ $labels.peer_ip }} []"
 description: "UPF [] PFCP []"

- alert: OmniPGW_UPF_PoolDegraded
 expr: (upf_peers_healthy / upf_peers_total) < 0.5
 for: 2m
 labels:
 severity: critical
 annotations:
 summary: "UPF []"
 description: "{{ $value | humanizePercentage }} % UPF []
 (< 50%)"

- alert: OmniPGW_UPF_HeartbeatFailures
 expr: upf_peer_missed_heartbeats > 2
 for: 30s
 labels:
 severity: warning
 annotations:
 summary: "UPF {{ $labels.peer_ip }} []"
 description: "{{ $value }} []"

- alert: OmniPGW_UPF_AllDown
 expr: upf_peers_healthy == 0 and upf_peers_total > 0
 for: 30s
 labels:
 severity: critical
 annotations:
 summary: "[] UPF []"
 description: "[] UPF []"

[]
- alert: OmniPGW_HighLatency
 expr: |
 histogram_quantile(0.95,
 rate(s5s8_inbound_handling_duration_bucket[5m])

```

```

) > 100000
 for: 5m
 labels:
 severity: warning
 annotations:
 summary: "OmniPGW 高CPU使用率"
 description: "p95 CPU 使用率 {{ $value }}µs (> 100ms)"

高メモリ使用率
- alert: OmniPGW_HighMemoryUsage
 expr: vm_memory_total > 2000000000
 for: 10m
 labels:
 severity: warning
 annotations:
 summary: "OmniPGW 高メモリ使用率"
 description: "VM メモリ使用量 {{ $value | humanize }}B"

- alert: OmniPGW_HighProcessCount
 expr: vm_system_process_count > 100000
 for: 10m
 labels:
 severity: warning
 annotations:
 summary: "OmniPGW 高プロセス数"
 description: "{{ $value }} Erlang プロセス数"

```

# AlertManager ☐☐

```
alertmanager.yml
global:
 resolve_timeout: 5m

route:
 receiver: 'ops-team'
 group_by: ['alertname', 'instance']
 group_wait: 10s
 group_interval: 10s
 repeat_interval: 12h

routes:
 - match:
 severity: critical
 receiver: 'pagerduty'

 - match:
 severity: warning
 receiver: 'slack'

receivers:
 - name: 'ops-team'
 email_configs:
 - to: 'ops@example.com'

 - name: 'slack'
 slack_configs:
 - api_url:
 'https://hooks.slack.com/services/YOUR/SLACK/WEBHOOK'
 channel: '#omnipgw-alerts'
 title: 'OmniPGW ☐☐☐{{ .GroupLabels.alertname }}'
 text: '{{ range .Alerts }}{{ .Annotations.description }}{{
end }}'

 - name: 'pagerduty'
 pagerduty_configs:
 - service_key: 'YOUR_PAGERDUTY_KEY'
```

---

□□□□

## □□□□□□ (KPI)

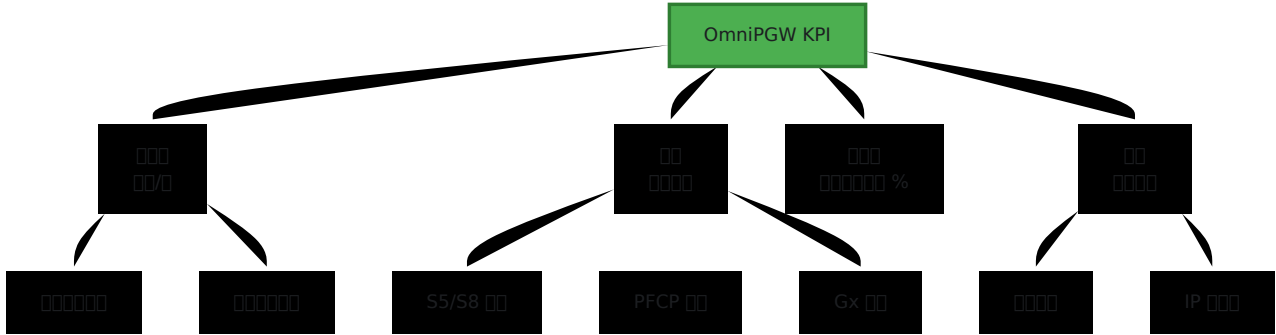

□□□□□□

□□□□□□□□

```
rate(s5s8_inbound_messages_total{message_type="create_session_request"
[5m])
```

□□□□□□□□

```
rate(s5s8_inbound_messages_total{message_type="delete_session_request"
[5m])
```

□□□□□□□□

```
rate(s5s8_inbound_messages_total{message_type="create_session_request"
[5m]) -
rate(s5s8_inbound_messages_total{message_type="delete_session_request"
[5m])
```

□□□□□□

□□□□□□□□□□□□□□

```
p50
histogram_quantile(0.50,
 rate(s5s8_inbound_handling_duration_bucket[5m])
)

p95
histogram_quantile(0.95,
 rate(s5s8_inbound_handling_duration_bucket[5m])
)

p99
histogram_quantile(0.99,
 rate(s5s8_inbound_handling_duration_bucket[5m])
)
```

□□□□□□□□□□

```
histogram_quantile(0.95,
 rate(s5s8_inbound_handling_duration_bucket[5m])
) by (request_message_type)
```

□□□□

□□□□□□**24**□□□□

```
teid_registry_count -
teid_registry_count offset 24h
```

□□□□□

```
□□□□□□ 10,000 □□
10000 - teid_registry_count
```

□□□□□□□□□□

```
1
(10000 - teid_registry_count) /
(rate(teid_registry_count[1h]) * 86400)
```

??

??

??

??

```
rate(s5s8_inbound_errors_total[5m]) by (message_type)
```

??

- ??
- ?? PCRF ??Gx ??
- ?? IP ??

??

??

```
histogram_quantile(0.95,
```

```
rate(s5s8_inbound_handling_duration_bucket{request_message_type="crea
[5m])
)
```

??

- ?? Gx ??PCRF ??
- ?? PFCP ??PGW-U ??

- 0000000000

### 000**PCRF** 0000

000

```
00 Gx 000000
sum(rate(gx_outbound_responses_total{result_code_class!="2xxx"}
[5m])) /
sum(rate(gx_outbound_responses_total[5m])) * 100

0 PCRF 0000
sum(rate(gx_outbound_responses_total[5m])) by (diameter_host,
result_code_class)

0000000000
rate(gx_outbound_responses_total{result_code_class="5xxx"}[5m]) by
(diameter_host)
```

000

- 00 PCRF 00000000
- 00 PCRF 00000000005xxx 000000000000
- 00 Diameter 0000
- 00 PCRF 0000000000
- 00 50120DIAMETER\_UNABLE\_TO\_COMPLY0000 Re-Auth-Request 00

0000000000

000

```
00000
rate(vm_memory_total[1h])

000000
rate(vm_memory_processes[1h])

000000
rate(vm_system_process_count[1h])
```

□□□

- □□□□□□
- □□□□□□
- □□□□□□□□□□

□□□□

□□□□□□□□□□

```
max_over_time(teid_registry_count[24h])
```

□□□□□□□□

```
teid_registry_count /
avg_over_time(teid_registry_count[7d])
```

□□□□□

```
abs(
 teid_registry_count -
 avg_over_time(teid_registry_count[1h])
) > 100
```

---

□□□□□

□□□□□

1. □□□□□ 15-30 □□□□□□□□□□□
2. □□□ 15 □□□□□□□□□□□
3. □□□ □□□□□□□□□□□□□□□□□□□

## □□□□

1. □□□□ - NOC □□□ KPI
2. □□□□ - □□□□□□□□
3. □□□□□□ - □□□□□□

## □□□□

1. □□□□□□ - □□□□□□□□□□□□
  2. □□ - □□ → □□□□□□□□□□
  3. □□□ - □□□□□□□□□□□□□□
- 

## □□□□

### □□□□□

- □□□□ - Prometheus □□□□Web UI □□
- □□□□□□ - □□□□□□□□

### □□□□

- **PFCP** □□ - PFCP □□□□□UPF □□□□
- **Diameter Gx** □□ - Gx □□□□□PCRF □□□□
- **Diameter Gy** □□ - Gy □□□□□□□□□□OCS □□
- **S5/S8** □□ - GTP-C □□□□□SGW-C □□

### □□□□

- **P-CSCF** □□ - P-CSCF □□□□□IMS □□
  - □□□□ - □□□□□□□□□□□□□□
  - **UE IP** □□ - IP □□□□□□
- 

## □□□□□

---

**OmniPGW** □□□□ - □ *OmniTouch* □□□□□□

# □□□□□□ (PCO)

□□□ **UE** □□□□□

*OmniPGW* □ *Omnitouch* □□□□□□

---

□□

**PCO** (□□□□□□) □□ PDN □□□□□□□□□□ UE (□□□□) □□□□□□□□□□□□ UE □□□□□□□□□□ DNS□  
IMS□□□□□□□□□□

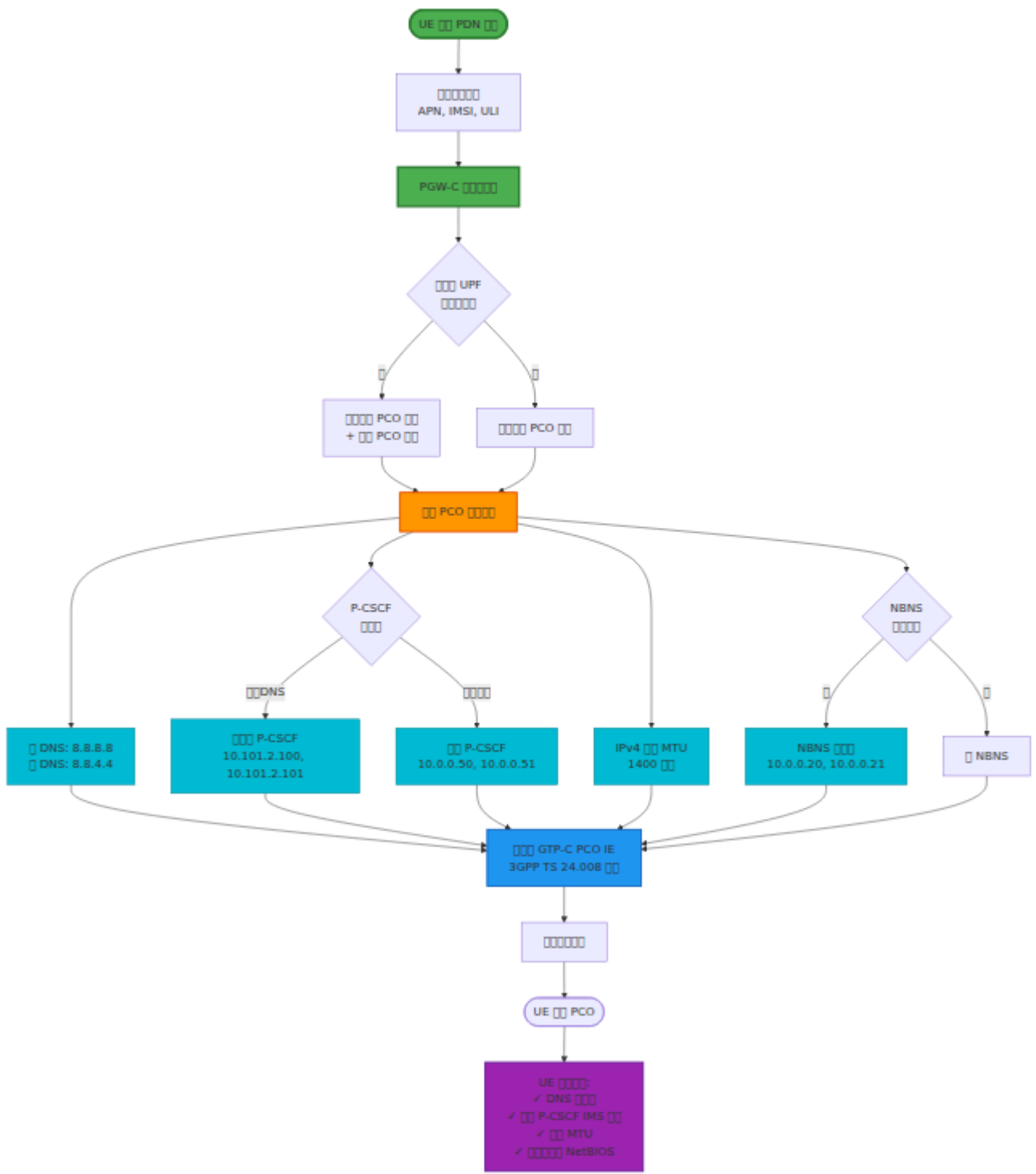

**PCO**

| IE 名称           | IE ID  | 描述            | 备注        |
|-----------------|--------|---------------|-----------|
| DNS 选项 IPv4 选项  | 0x000D | DNS 选项        |           |
| DNS 选项 IPv4 选项  | 0x000D | DNS 选项        |           |
| P-CSCF IPv4 选项  | 0x000C | IMS 选项 P-CSCF | IMS (IMS) |
| IPv4 选项 MTU     | 0x0010 | MTU 选项        |           |
| NBNS 选项 IPv4 选项 | 0x0011 | NetBIOS 选项    |           |

---

□□

□□□□

```
config/runtime.exs
config :pgw_c,
 pco: %{
 # DNS □□□ (□□)
 primary_dns_server_address: "8.8.8.8",
 secondary_dns_server_address: "8.8.4.4",

 # NBNS □□□ (□□□□□□□□ Windows □□)
 primary_nbns_server_address: nil,
 secondary_nbns_server_address: nil,

 # IMS/VoLTE □ P-CSCF □□ (□□)
 p_cscf_ipv4_address_list: [],

 # P-CSCF □□□□ (□□)
 p_cscf_discovery_enabled: false,
 p_cscf_discovery_dns_server: nil,
 p_cscf_discovery_timeout_ms: 5000,

 # IPv4 MTU □□ (□□)
 ipv4_link_mtu_size: 1400
 }
```

---

**PCO** □□

**DNS** □□□□□

□ **DNS** □□ **DNS**□

```
pco: %{
 primary_dns_server_address: "8.8.8.8",
 secondary_dns_server_address: "8.8.4.4"
}
```

## DNS

|                   | Primary DNS    | Secondary DNS   |
|-------------------|----------------|-----------------|
| <b>Google</b>     | 8.8.8.8        | 8.8.4.4         |
| <b>Cloudflare</b> | 1.1.1.1        | 1.0.0.1         |
| <b>Quad9</b>      | 9.9.9.9        | 149.112.112.112 |
| <b>OpenDNS</b>    | 208.67.222.222 | 208.67.220.220  |

## DNS

```
pco: %{
 primary_dns_server_address: "10.0.0.10",
 secondary_dns_server_address: "10.0.0.11"
}
```

## P-CSCF (IMS)

### IMS/VoLTE

```
pco: %{
 p_cscf_ipv4_address_list: [
 "10.0.0.50", # P-CSCF
 "10.0.0.51" # P-CSCF
]
}
```

## P-CSCF (IPv4)

- IMS ــــــــــــــــ
- VoLTE/VoWiFi/RCS ــــــــ
- UE ــــــــــــــــ SIP

## P-CSCF ــــــــ

### ــــــــ DNS ــــــــ P-CSCF ــــــــ

OmniPGW ــــــــ DNS ــــــــ P-CSCF ــــــــ 3GPP TS 23.003 ــــــــ TS 24.229 ــــــــ  
 ــــــــPGW-C ــــــــ DNS ــــــــ P-CSCF ــــــــ

```
pco: %{
 # ــــــــ P-CSCF ــــــــ
 p_cscf_discovery_enabled: true,

 # P-CSCF ــــــــ DNS ــــــــ (ــــــــ)
 p_cscf_discovery_dns_server: {10, 179, 2, 177},

 # DNS ــــــــ (ــــــــ)
 p_cscf_discovery_timeout_ms: 5000,

 # ــــــــ P-CSCF ــــــــ (ــــــــ DNS ــــــــ)
 p_cscf_ipv4_address_list: ["10.0.0.50"]
}
```

### ــــــــ

1. ــــــــ `p_cscf_discovery_enabled: true` ــــــــPGW-C ــــــــ DNS ــــــــ P-CSCF ــــــــ
2. DNS ــــــــ `p_cscf_discovery_dns_server`
3. ــــــــ DNS ــــــــ P-CSCF ــــــــ PCO ــــــــ UE
4. ــــــــ DNS ــــــــ `p_cscf_ipv4_address_list`
5. ــــــــ P-CSCF ــــــــ

# P-CSCF 配置

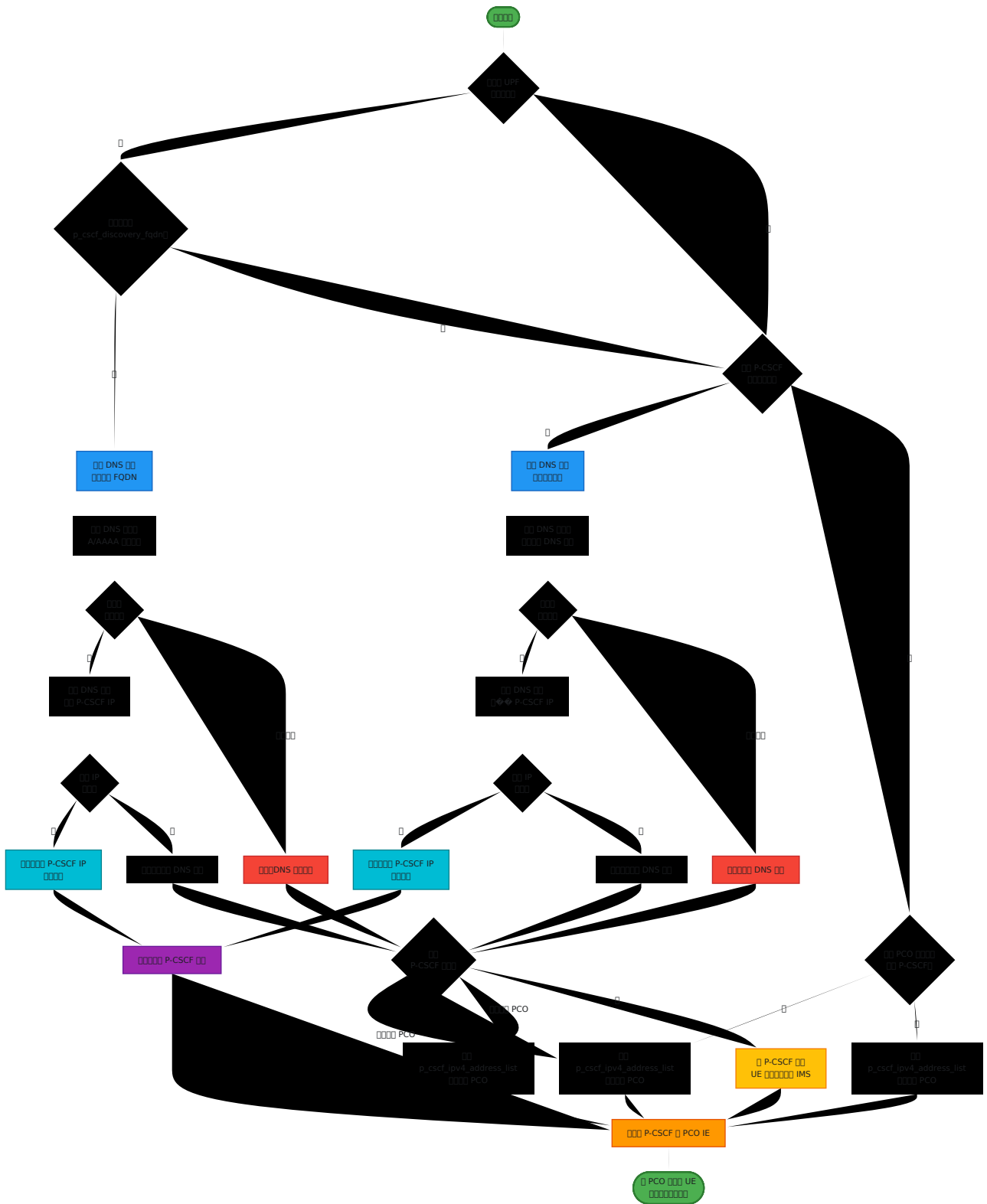

配置

- 配置 **FQDN** (配置) - `p_cscf_discovery_fqdn` 配置 UPF 配置
- 配置 **DNS** (配置) - `p_cscf_discovery_enabled: true` 配置 PCO 配置

- 3. **PCO** `p_cscf_ipv4_address_list` PCO
- 4. **PCO** ( ) - `p_cscf_ipv4_address_list` PCO

P-CSCF

- DNS
- 
- 
- 

P-CSCF

| <code>p_cscf_discovery_enabled</code>    |      | <code>false</code> | DNS P-CSCF                     |
|------------------------------------------|------|--------------------|--------------------------------|
| <code>p_cscf_discovery_dns_server</code> | (IP) | <code>nil</code>   | DNS IP 4 ( {10, 179, 2, 177} ) |
| <code>p_cscf_discovery_timeout_ms</code> |      | <code>5000</code>  | DNS                            |

- **IMS** - P-CSCF DNS
- - DNS P-CSCF
- - DNS P-CSCF
- - P-CSCF

DNS IMS

```

pco: %{
 primary_dns_server_address: "10.0.0.10",
 secondary_dns_server_address: "10.0.0.11",

 # P-CSCF
 p_cscf_discovery_enabled: true,
 p_cscf_discovery_dns_server: {10, 179, 2, 177}, # IMS DNS
 p_cscf_discovery_timeout_ms: 3000,

 # P-CSCF (DNS)
 p_cscf_ipv4_address_list: [
 "10.0.0.50", #
 "10.0.0.51" #
],

 ipv4_link_mtu_size: 1400
}

```

## P-CSCF

P-CSCF UPF APN DNS P-CSCF

```

upf_selection
rules: [
 %{
 name: "IMS",
 priority: 20,
 match_field: :apn,
 match_regex: "^ims",
 upf_pool: [...],

 # P-CSCF
 p_cscf_discovery_fqdn: "pcscf.mnc380.mcc313.3gppnetwork.org"
 }
]

```

P-CSCF UPF

P-CSCF P-CSCF

# NBNS 配置 (NetBIOS)

## Windows 配置

```
pco: %{\n primary_nbns_server_address: "10.0.0.20",\n secondary_nbns_server_address: "10.0.0.21"\n}
```

## 配置

- Windows 配置
- 配置
- NetBIOS 配置

## MTU 配置

### 配置

```
pco: %{\n ipv4_link_mtu_size: 1400 # \n}
```

## MTU 配置

| MTU  | 配置          |
|------|-------------|
| 1500 | 配置          |
| 1400 | 配置 GTP 配置   |
| 1420 | 配置          |
| 1280 | IPv6 配置 MTU |
| 1360 | VPN/配置      |

□□□ □□ LTE □□ **1400** □□□ GTP-U □□□

---

□□□□

## Internet APN

```
pco: %{
 primary_dns_server_address: "8.8.8.8",
 secondary_dns_server_address: "8.8.4.4",
 ipv4_link_mtu_size: 1400
}
```

## IMS APN

```
pco: %{
 primary_dns_server_address: "10.0.0.10",
 secondary_dns_server_address: "10.0.0.11",
 p_cscf_ipv4_address_list: [
 "10.0.0.50",
 "10.0.0.51"
],
 ipv4_link_mtu_size: 1400
}
```

□□ **P-CSCF** □□ □□□ IMS □□□□□□ P-CSCF □□□□

## PCO APN

```
pco: %{
 primary_dns_server_address: "10.100.0.10",
 secondary_dns_server_address: "10.100.0.11",
 primary_nbns_server_address: "10.100.0.20",
 secondary_nbns_server_address: "10.100.0.21",
 ipv4_link_mtu_size: 1400
}
```

## PCO 与 GTP-C 交互

交互过程

OmniPGW 与 PCO 交互

```
PCO 交互
├─ 消息: 消息
├─ UE IP 地址: 100.64.1.42
├─ PCO (消息)
│ ├─ DNS 服务器 IPv4 地址: 8.8.8.8
│ ├─ DNS 服务器 IPv4 地址: 8.8.4.4
│ ├─ P-CSCF IPv4 地址: 10.0.0.50
│ ├─ P-CSCF IPv4 地址: 10.0.0.51
│ └─ IPv4 地址 MTU: 1400
```

## UE 交互

UE 与 PCO 交互

1. 接收 DNS 服务器
2. 接收 P-CSCF 和 IMS 地址
3. 接收 MTU 大小

# □□□□

## □□□**UE** □□□□ **DNS**

□□□

- UE □ IP □□□□□□□□□□
- DNS □□□□

□□□□□

1. PCO □□□□ DNS □□□□□□□□
2. □ UE IP □□□□□ DNS □□□
3. □□□□□ DNS □□

□□□□□

```
□□ DNS □□□□□□
ping 8.8.8.8

□□ UE □□□□ DNS □□
nslookup google.com 8.8.8.8

□□ PCO □□
grep "primary_dns_server_address" config/runtime.exs
```

## □□□**IMS** □□□□

□□□

- VoLTE □□□□
- UE □□“□ IMS □□”

□□□□□

1. □□ P-CSCF □□
2. P-CSCF IP □□□□□
3. P-CSCF □□□□

□□□□

```
□□ P-CSCF □□
pco: %{\br/> p_cscf_ipv4_address_list: ["10.0.0.50"] # □□□□
}
```

## □□□**MTU** □□

□□□

- □□□□□□□□□□□□□□□□
- □□□□□□□
- □□□□

□□□□

- MTU □□□□□□□□
- MTU □□□□□□□□

□□□□

```
□□□GTP □□□□ 1400
pco: %{\br/> ipv4_link_mtu_size: 1400
}

□□□□□□□□□□□□□□□□
pco: %{\br/> ipv4_link_mtu_size: 1360
}
```

---

□□□□

## DNS □□

### 1. □□□□ DNS □□□

- □□□Google (8.8.8.8)□Cloudflare (1.1.1.1)
- □□□□□□ DNS

### 2. □□□□□ DNS

- □□□□
- □□□□□

### 3. □□ DNS □□□

- □□ DNSSEC □□□□
- □□ DNS □□□□□□□□

## IMS □□

### 1. □□□□ P-CSCF

- □□ 2 □□□□□□
- □□□□□□□□□□

### 2. □□□□□

- P-CSCF □□□□ UE IP □□□
- □□ SIP □□□

## MTU □□

### 1. □□□□

- GTP-U: 36 □□ (IPv4)
- IPsec: □□ (50-100 □□)

## 2. LTE MTU

- MTU 1400
- MTU

## 3. MTU

- MTU
- MTU

MTU

MTU

- runtime.exs UPF PCO
- UE IP - IP APN
- P-CSCF - P-CSCF

MTU

- PDN
- S5/S8 - GTP-C PCO
- PFCP -

## IMS VoLTE

- Diameter Gx - IMS
- PCO

MTU

OmniPGW PCO - Omnitouch

# P-CSCF

P-CSCF

OmniPGW Omnitouch

---

**P-CSCF** DNS SRV IMS P-CSCF SIP OPTIONS

- **P-CSCF**
- DNS 60
- **SIP OPTIONS** ping P-CSCF
  - TCP SIP OPTIONS
  - UDP TCP UDP
  - :up :down
- Web UI IP
- 
- **Prometheus** Prometheus

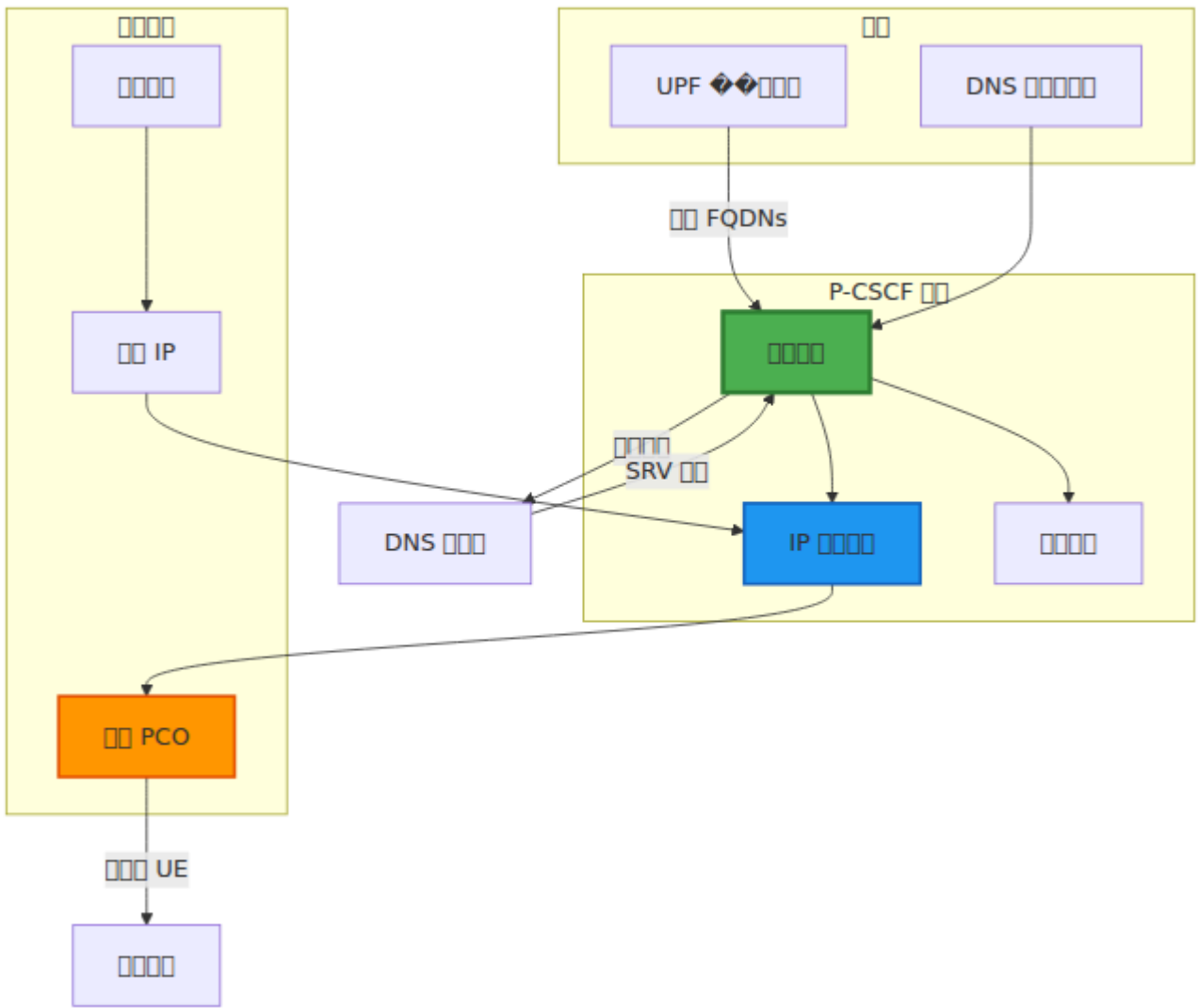

□□

1. □□□□
2. □□
3. □□□□
4. Web UI □□
5. □□□□□□□□
6. □□□□
7. DNS □□
8. □□□□
9. □□□□

□□□□

□□□□

```
config/runtime.exs

□□ PCO □□□□ P-CSCF □□ DNS □□□□
config :pgw_c,
 pco: %{
 p_cscf_discovery_dns_server: "10.179.2.177",
 p_cscf_discovery_enabled: true,
 p_cscf_discovery_timeout_ms: 5000
 },

 upf_selection: %{
 rules: [
 # IMS □□ - □□ P-CSCF □□
 %{
 name: "IMS □□",
 priority: 20,
 match_field: :apn,
 match_regex: "^ims",
 upf_pool: [
 weight: 80}
 %{remote_ip_address: "10.100.2.21", remote_port: 8805,
],
 # P-CSCF □□ FQDN□□□□□□ UPF □□□□□□□□□□□□□□
 p_cscf_discovery_fqdn:
"pcscf.mnc380.mcc313.3gppnetwork.org",
 # □□□□□□□□ PCO □□□□□□
 pco: %{
 p_cscf_ipv4_address_list: ["10.101.2.100",
"10.101.2.101"]
 }
 }
]
 }
}
```

□□□ □□□□ □□□□□□ UPF □□□□□□□□□□ PCO □□ □□□□□ P-CSCF □□□□□

## □□□□

1. □□ OmniPGW
  2. □□□ **Web UI → P-CSCF** □□ ([https://localhost:8086/pcscf\\_monitor](https://localhost:8086/pcscf_monitor))
  3. □□□□□□□□□□ IP
- 

## □□

### □□ **P-CSCF** □□□□

□ PCO □□□□□□ P-CSCF □□□ DNS □□□□

```
pco: %{\n # □□ P-CSCF □□□ DNS □□□□□□□□ UE □ DNS □□□\n p_cscf_discovery_dns_server: "10.179.2.177",\n\n # □□ P-CSCF DNS □□□□\n p_cscf_discovery_enabled: true,\n\n # DNS SRV □□□□□□□□□□\n p_cscf_discovery_timeout_ms: 5000,\n\n # □□ P-CSCF □□□□□□□□□□\n p_cscf_ipv4_address_list: ["10.101.2.146"]\n}
```

### □□□ **P-CSCF FQDNs**

□□ UPF □□□□□□□□□□□□□□ P-CSCF □□ FQDN□

```

upf_selection: %{
 rules: [
 # IMS 000 - IMS 0000 P-CSCF
 %{
 name: "IMS 000",
 match_field: :apn,
 match_regex: "^ims",
 upf_pool: [...],
 p_cscf_discovery_fqdn:
"pcscf.ims.mnc380.mcc313.3gppnetwork.org",
 pco: %{
 p_cscf_ipv4_address_list: ["10.101.2.100"] # 000
 }
 },

 # 000 - 0000000 P-CSCF
 %{
 name: "0000000",
 match_field: :apn,
 match_regex: "^enterprise",
 upf_pool: [...],
 p_cscf_discovery_fqdn: "pcscf.enterprise.example.com",
 pco: %{
 p_cscf_ipv4_address_list: ["192.168.1.50"] # 000
 }
 },

 # 0000 - 0 P-CSCF 0000000000000000
 %{
 name: "0000000",
 match_field: :apn,
 match_regex: "^internet",
 upf_pool: [...]
 # 0 p_cscf_discovery_fqdn - 00000 PCO 000
 }
]
}

```

□□□□

□□□□

### 1. □□□□

- P-CSCF □□ GenServer □□□
- □□□□□□ UPF □□□□□□□□□□□□ P-CSCF FQDNs

### 2. FQDN □□

- □□□□□ FQDN □□□□□□□□□□
- □□□□□□ FQDN □□□□ DNS SRV □□
- **SIP OPTIONS** □□□□□□□□□□□□□□□□□□
  - □□□□ TCP□SIP/2.0/TCP □ 5060 □□□
  - □□ TCP □□□□□□□□ UDP□SIP/2.0/UDP □ 5060 □□□
  - □□□□□□□□□ □:up□□□□□□□ □:down□□□□/□□□
- □□□IP□□□□□□□□□□□□□□□□□□□□□□

### 3. □□□□□□ 60 □□

- □□□□□□□□ FQDNs
- DNS □□□□□□□□□□□□□□
- □□□□□□□□□□□□
  - □□ TCP □□ SIP OPTIONS□□□□□5 □□
  - □□ TCP □□□□□□□□ UDP□□□□□5 □□
  - □□□□□□□□□□□□
- □□□□□□□□□□ DNS □□□□□□□□

# □□□□□□

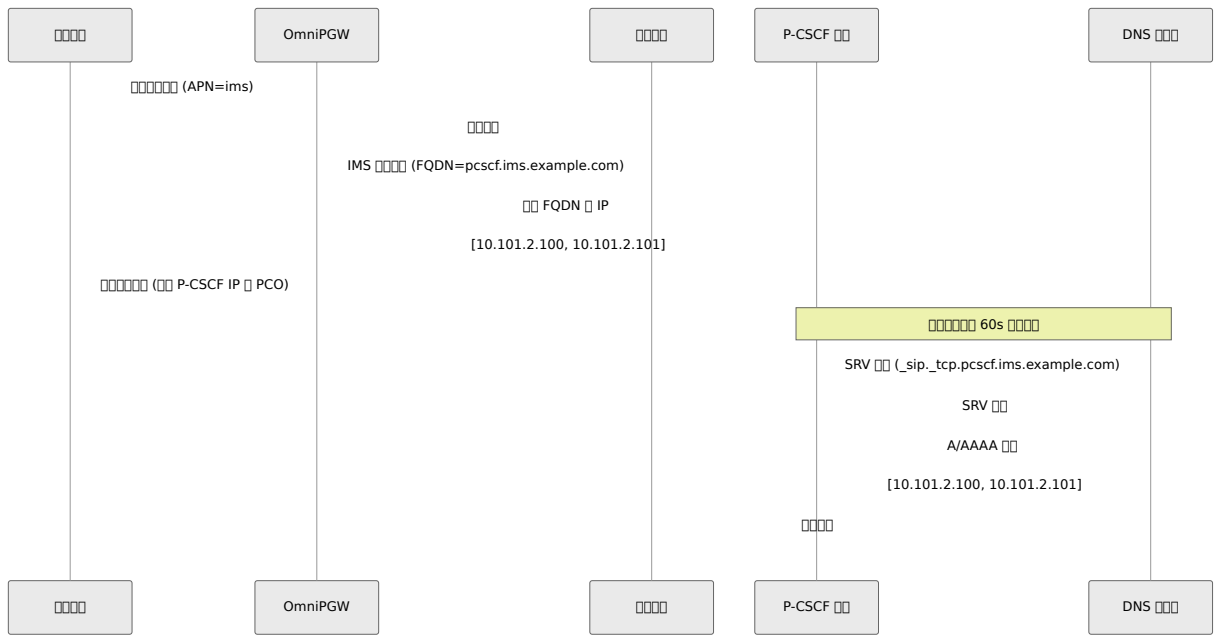

## DNS □□□□

□□□□ **DNS SRV** □□ □□□□ P-CSCF □□□

1. **SRV** □□□□ `_sip._tcp.{fqdn}` □ SRV □□
2. □□□□□□□□□□□□□□□□
3. □□□□□□ SRV □□□□□□□□□□
4. □□□□□□□□□□□□□□□□ IP □□□A/AAAA □□□
5. □□□□□□□□ IP □□□□□□□□

## P-CSCF □□□□□□□

□□□□□□□□□ **FQDN** □□□ **PCO** □□**FQDN** □□□

```

%{
 name: "IMS ",
 p_cscf_discovery_fqdn: "pcscf.mnc380.mcc313.3gppnetwork.org", #
← ""
 pco: %{
 p_cscf_ipv4_address_list: ["10.101.2.100", "10.101.2.101"] #
← ""
 }
}

```

Table

| Field                                       | P-CSCF                              | IP     | Value                                 |
|---------------------------------------------|-------------------------------------|--------|---------------------------------------|
| <b>FQDN</b><br>pco.p_cscf_discovery_fqdn    | DNS<br>pco.p_cscf_discovery_fqdn    | DNS IP | "FQDN<br>pcscf.example.com<br>P-CSCF" |
| <b>FQDN</b><br>pco.p_cscf_ipv4_address_list | PCO<br>pco.p_cscf_ipv4_address_list | IP     | "FQDN P-CSCF IPs...,<br>"             |
| <b>FQDN</b><br>pco.p_cscf_ipv4_address_list | PCO<br>pco.p_cscf_ipv4_address_list | IP     |                                       |
|                                             | PCO<br>pco.p_cscf_ipv4_address_list | IP     |                                       |
| <b>FQDN</b>                                 | PCO<br>pco.p_cscf_ipv4_address_list | IP     |                                       |

Table

# IMS 配置

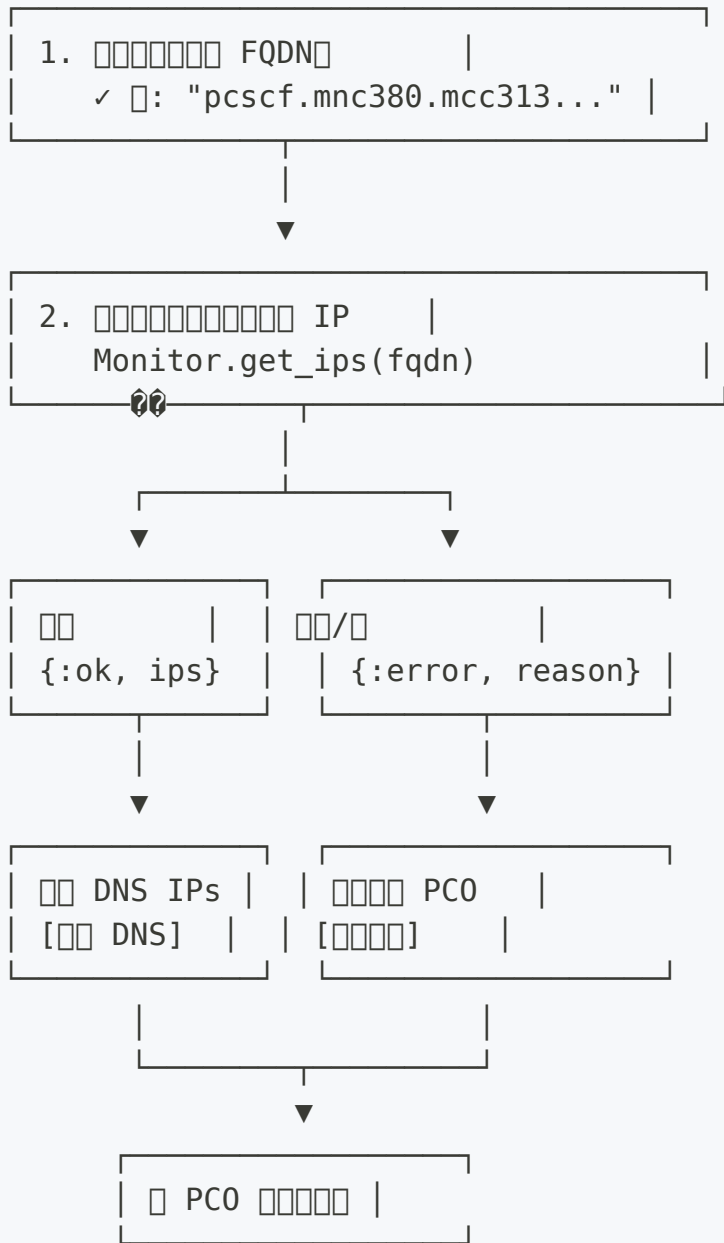

配置

1. DNS 配置

```
UE:
 p_cscf_discovery_fqdn: "pcscf.ims.example.com"
 pco.p_cscf_ipv4_address_list: ["10.101.2.100"]
```

```
DNS UE: [10.101.2.150, 10.101.2.151]
UE UE: [10.101.2.150, 10.101.2.151] ← DNS
UE: DNS PCO UE
```

## 2 DNS

```
UE:
 p_cscf_discovery_fqdn: "pcscf.ims.example.com"
 pco.p_cscf_ipv4_address_list: ["10.101.2.100"]
```

```
DNS UE: ERROR :no_naptr_records
UE UE: [10.101.2.100] ← PCO
UE: DNS
```

## 3 FQDN

```
UE:
 # p_cscf_discovery_fqdn
 pco.p_cscf_ipv4_address_list: ["192.168.1.50"]
```

```
UE UE: [192.168.1.50] ← PCO
UE: DNS
```

## 

1. DNS
2. DNS
- 3.
- 4.

FQDN PCO

```
✓ PC: PC00000000
%{
 p_cscf_discovery_fqdn: "pcscf.ims.example.com", # PC
 pco: %{
 p_cscf_ipv4_address_list: ["10.101.2.100"] # PC
 }
}

△ PC: PC0000000000 PC00
%{
 p_cscf_discovery_fqdn: "pcscf.ims.example.com"
 # PC0000000000
}

✓ PC: PC000000 DNS PC00
%{
 pco: %{
 p_cscf_ipv4_address_list: ["192.168.1.50"]
 }
}
```



---

## Web UI

### P-CSCF

PC00000000 [https://localhost:8086/pcscf\\_monitor](https://localhost:8086/pcscf_monitor)



- 0000
  - 0000 000000000000 FQDNs
  - 1 **FQDN** 0000000000 FQDN
  - 0000000000 5 000000
  
- 00000000
  - 1 **FQDNs**000000000000 FQDN 00
  - 00000000 DNS 000000 FQDNs
  - **DNS** 000000000000 FQDNs
  -  **P-CSCF** 00000000 FQDNs 0000000000
  - ✓ 000**SIP OPTIONS** 00000000 SIP OPTIONS 0000000000
  - X 0000**SIP OPTIONS** 0000000000 SIP OPTIONS 0000
  - **DNS** 00000000 DNS 0000
  - 00000000SIP OPTIONS 000000000060s~5s 0000

0000000000 DNS 000000 P-CSCF 000000000000000000000000 SIP OPTIONS

**UPF** 00000000

UPF 0000 (/upf\_selection) 00000000 P-CSCF 000000

```

[] IMS [] ([][] 20)
 []: APN [] ^ims
 []: UPF-IMS-Primary (10.100.2.21:8805)

[] P-CSCF []
 FQDN: pcscf.mnc380.mcc313.3gppnetwork.org
 []: ✓ [] (2 [] IP)
 [] IPs: 10.101.2.100, 10.101.2.101

⚙️ PCO []
 [] DNS: 10.103.2.195
 P-CSCF[]: 10.101.2.100, 10.101.2.101

```

□□□□□□□□

## Prometheus []

P-CSCF [] Prometheus [] 42069[]

### Gauge []

```

FQDN []
pcscf_fqdns_total # [] FQDN []
pcscf_fqdns_resolved # [] FQDNs[]DNS []
pcscf_fqdns_failed # [] FQDNs[]DNS []

[]
pcscf_servers_total # [] DNS SRV [] P-CSCF []
[]
pcscf_servers_healthy # [] SIP OPTIONS []
pcscf_servers_unhealthy # [] SIP OPTIONS []

[] FQDN []
pcscf_servers_healthy{fqdn="..."} # [] FQDN []
pcscf_servers_unhealthy{fqdn="..."} # [] FQDN []

```

□□□□□□

- **healthy**: 成功した SIP OPTIONS ping (TCP 及 UDP)
- **unhealthy**: 失敗した SIP OPTIONS (5s 以内)

概要

## DNS 監視

```
成功した FQDNs
pcscf_fqdns_resolved

DNS 成功率
(pcscf_fqdns_resolved / pcscf_fqdns_total) * 100

総サーバー数
pcscf_servers_total
```

## SIP OPTIONS 監視

```
成功した FQDNs
pcscf_servers_healthy

失敗した FQDNs
pcscf_servers_unhealthy

SIP OPTIONS 成功率
(pcscf_servers_healthy / pcscf_servers_total) * 100

特定の FQDN 監視
pcscf_servers_healthy{fqdn="pcscf.mnc380.mcc313.3gppnetwork.org"}

監視条件 (健康なサーバーが 0 であり、総サーバー数 > 0)
pcscf_servers_healthy == 0 AND pcscf_servers_total > 0
```

## Prometheus 監視

```

[] P-CSCF []
- alert: AllPCSCFServersDown
 expr: pcscf_servers_healthy == 0 AND pcscf_servers_total > 0
 for: 5m
 labels:
 severity: critical
 annotations:
 summary: "[] P-CSCF []"
 description: "{{ $value }} [] (0) - [] SIP OPTIONS []"

[] 50% []
- alert: MajorityPCSCFServersDown
 expr: (pcscf_servers_healthy / pcscf_servers_total) < 0.5
 for: 5m
 labels:
 severity: warning
 annotations:
 summary: "[] P-CSCF []"
 description: "[] {{ $value }}% [] SIP OPTIONS"

[] DNS []
- alert: PCSCFDNSResolutionFailed
 expr: pcscf_fqdns_failed > 0
 for: 5m
 labels:
 severity: warning
 annotations:
 summary: "P-CSCF DNS []"
 description: "{{ $value }} [] FQDN []"

```

[][][]

[][][][][]

```
[info] P-CSCF [] []
[info] [] 2 [] [] P-CSCF FQDNs [] []: ["pcscf.ims.example.com",
"pcscf.enterprise.example.com"]
[info] P-CSCF []: [] FQDN pcscf.ims.example.com
[debug] P-CSCF []: [] pcscf.ims.example.com [] 2 [] IP
[warning] P-CSCF []: [] pcscf.enterprise.example.com: :nxdomain
[debug] [] FQDN pcscf.ims.example.com [] P-CSCF []: [{10, 101,
2, 100}, {10, 101, 2, 101}]
```

□□□□

□□□□ □□□□ □□□□□□□□

## □ 1 □□DNS □□□□□□

```
p_cscf_discovery_fqdn: "pcscf.ims.example.com"
```

- □□□□ DNS □□□□□□ IP
- □□□□□□□□ IP
- □□□□□□□□□□□□□□

## □ 2 □□□□□□□□□□ PCO□□□□

```
pco: %{
 p_cscf_ipv4_address_list: ["10.101.2.100", "10.101.2.101"]
}
```

- □□ DNS □□□□□□□□ IP□□□□
- □□□□□□□□□□
- □□□□□□□□□□□□□□

### 3. PCO 配置

```
PCO 配置
pco: %{
 p_cscf_ipv4_address_list: ["10.101.2.146"]
}
```

- DNS 配置
- P-CSCF 配置
- 其他配置

### 配置

配置 "IMS 配置" 配置

1. DNS 配置 "pcscf.ims.example.com"
  - └ IP → [10.101.2.100, 10.101.2.101] ✓
  - └ 配置 → 配置
2. PCO 配置
  - └ IP → [10.101.2.100, 10.101.2.101] ✓
  - └ 配置 → 配置
3. PCO 配置
  - └ IP [10.101.2.146] ✓ (配置)

## DNS 配置

### DNS 配置

DNS 配置 SRV 及 A/AAAA 记录 P-CSCF 配置

```

; P-CSCF SRV _sip._tcp
_sip._tcp.pcscf.mnc380.mcc313.3gppnetwork.org. IN SRV 10 50 5060
pcscf1.example.com.
_sip._tcp.pcscf.mnc380.mcc313.3gppnetwork.org. IN SRV 20 50 5060
pcscf2.example.com.

; A
pcscf1.example.com. IN A 10.101.2.100
pcscf2.example.com. IN A 10.101.2.101

```

OmniPGW FQDN `_sip._tcp.` `p_cscf_discovery_fqdn:`  
`"pcscf.mnc380.mcc313.3gppnetwork.org"`  
`_sip._tcp.pcscf.mnc380.mcc313.3gppnetwork.org`

## SRV

SRV

```

_service._proto.domain. IN SRV priority weight port target.

```

- 10 20
- =
- SIP TCP 5060 UDP 5060
- IP

## DNS

```
SRV _sip._tcp
dig SRV _sip._tcp.pcscf.mnc380.mcc313.3gppnetwork.org
@10.179.2.177

#
_sip._tcp.pcscf.mnc380.mcc313.3gppnetwork.org. 300 IN SRV 10 50
5060 pcscf1.example.com.

P-CSCF IP
dig A pcscf1.example.com @10.179.2.177

#
pcscf1.example.com. 300 IN A 10.101.2.100
```

## 

## FQDN “”

- Web UI X
- :nxdomain :timeout :no\_naptr\_records

1. DNS
2. FQDN DNS
3. NAPTR
4. DNS

```
1. DNS ping
ping 10.179.2.177

2. NAPTR
dig NAPTR pcscf.mnc380.mcc313.3gppnetwork.org @10.179.2.177

3. OmniPGW log
grep "P-CSCF" /var/log/pgw_c.log

4.
grep "p_cscf_discovery_dns_server" config/runtime.exs

5. Web UI
FQDN "0" IP
```

## IP

- Web UI "0 IP"
- ✓ X

1. NAPTR FQDN
2. IMS/SIP
3. A/AAAA

```
NAPTR
dig NAPTR pcscf.example.com @10.179.2.177

"SIP" "IMS":
: "SIP+D2U", "x-3gpp-ims:sip"
: "HTTP", "FTP"

A/AAAA
dig pcscf1.example.com A @10.179.2.177
```

# 如何配置 P-CSCF

如何

- UE 如何配置 P-CSCF 地址
- 如何配置 P-CSCF IP

如何

1. DNS 如何配置
2. 如何配置
3. FQDN 如何

如何

```
1. 如何 P-CSCF 地址
如何 FQDN 如何

2. 如何
grep "如何 FQDN 如何 P-CSCF 如何" /var/log/pgw_c.log

3. 如何 UPF 如何
如何 FQDN 如何

4. 如何
如何 APN 如何
```

# 如何配置 DNS 如何

如何

- 如何
- 如何 `pcscf_discovery_query_duration_seconds`

如何

1. DNS 如何
2. 如何 DNS 如何
3. 如何

□□□□

```
□□□□□□
pco: %{
 p_cscf_discovery_timeout_ms: 2000 # □ 5000ms □□
}

□□□□□□□□ DNS □□□
pco: %{
 p_cscf_discovery_dns_server: "10.0.0.10" # □□ DNS
}
```

□□□□

## 1. DNS □□□□□

□□□□ DNS □◀▶

```
pco: %{
 # □□□ P-CSCF □□□ DNS□□ UE DNS □□□
 p_cscf_discovery_dns_server: "10.179.2.177",

 # UE DNS □□□□□□□□□□□□□□
 primary_dns_server_address: "8.8.8.8",
 secondary_dns_server_address: "8.8.4.4"
}
```

□□□□

- □□□□□□ UE DNS □□□ IMS DNS
- □□□□□□□□□□□□
- □□□□□□□□

## 2. 配置示例

```
%{
 p_cscf_discovery_fqdn: "pcscf.ims.example.com", # 配置
 pco: %{
 p_cscf_ipv4_address_list: ["10.101.2.100"] # 配置
 }
}
```

配置

- 配置 DNS 配置
- 配置
- 配置 SLA 配置

## 3. 配置示例 **FQDN**

```
rules: [
 # IMS
 %{
 name: "IMS",
 match_regex: "^ims",
 p_cscf_discovery_fqdn:
"pcscf.ims.mnc380.mcc313.3gppnetwork.org"
 },

 # 配置
 %{
 name: "配置",
 match_regex: "^enterprise",
 p_cscf_discovery_fqdn: "pcscf.enterprise.example.com"
 }
]
```

配置

- 配置 P-CSCF 配置
- 配置

- `severity: warning`

## 4. `HighPCSCFQueryLatency` DNS `Warning`

```
HighPCSCFQueryLatency alert
alert: HighPCSCFQueryLatency
expr: histogram_quantile(0.95,
pcscf_discovery_query_duration_seconds_bucket) > 2
for: 5m
labels:
 severity: warning
annotations:
 summary: "P-CSCF DNS Warning (p95 > 2s)"
```

## 5. `pcscf_monitor_fqdns_failed` DNS `Warning`

- **Web UI** `HighPCSCFQueryLatency` P-CSCF `Warning`
- `pcscf_monitor_fqdns_failed` `Warning`
- `pcscf_monitor_fqdns_failed` DNS `Warning`
- `pcscf_monitor_fqdns_failed` DNS `Warning`

## 6. `pcscf_monitor_fqdns_failed` DNS `Warning`

```
pcscf_monitor_fqdns_failed alert
pco: %{
 p_cscf_discovery_timeout_ms: 5000 # 5
}

pcscf_monitor_fqdns_failed alert
pco: %{
 p_cscf_discovery_timeout_ms: 2000 # 2
}
```

## 7. `pcscf_monitor_fqdns_failed` DNS `Warning`

`pcscf_monitor_fqdns_failed` DNS `Warning`

```
P-CSCF DNS
pcscf.mnc380.mcc313.3gppnetwork.org. IN NAPTR 10 50 "s" "SIP+D2U"
"" _sip._udp.pcscf1.example.com.
```

```
P-CSCF DNS
pcscf.mnc380.mcc313.3gppnetwork.org. IN NAPTR 20 50 "s" "SIP+D2U"
"" _sip._udp.pcscf2.example.com.
```

---

## □□□□

- **PCO** □□ - □□□□□□□□ DNS □ P-CSCF □□
- □□□□ - □□□□ OmniPGW □□□□
- □□ - □□□□□□□□□□
- □□□□ - □□□□□□□□ PCO □□
- **PFCP** □□ - □□□□□□□□

---

## □□□□□

---

**OmniPGW P-CSCF** □□ - □ *OmniTouch* □□□□□□□□

# PFCP/Sxb

PGW-C & PGW-U

---

## 

- - 
  - PFCP
  - PFCP
  - 
  - 
  - DNS & UPF
  - 
  - 
  - Web UI - PFCP
  -
- 

## 

**Sxb** PGW-C & PGW-U

- PGW-C -
- PGW-U -

# PFCP

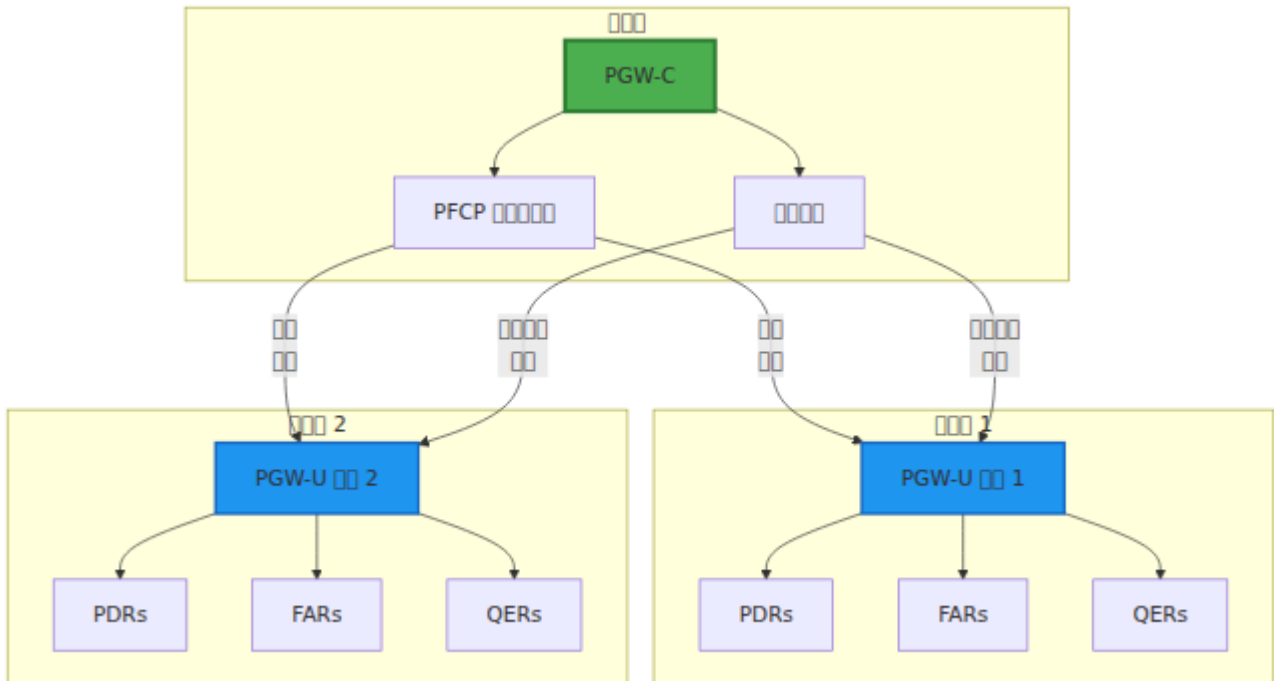

PFCP

# PFCP

PGW-C PFCP 1 3GPP TS 29.244

PFCP

- UDP
- 8805
- PFCP

PFCP ID

PFCP ID ID

- IPv4 -
- IPv6

- FQDN□□□□□□□□
- 

## PFCP □□□□

□□□□□□□□□□ PGW-C □ PGW-U □□□□ PFCP □□□

□□□□□□

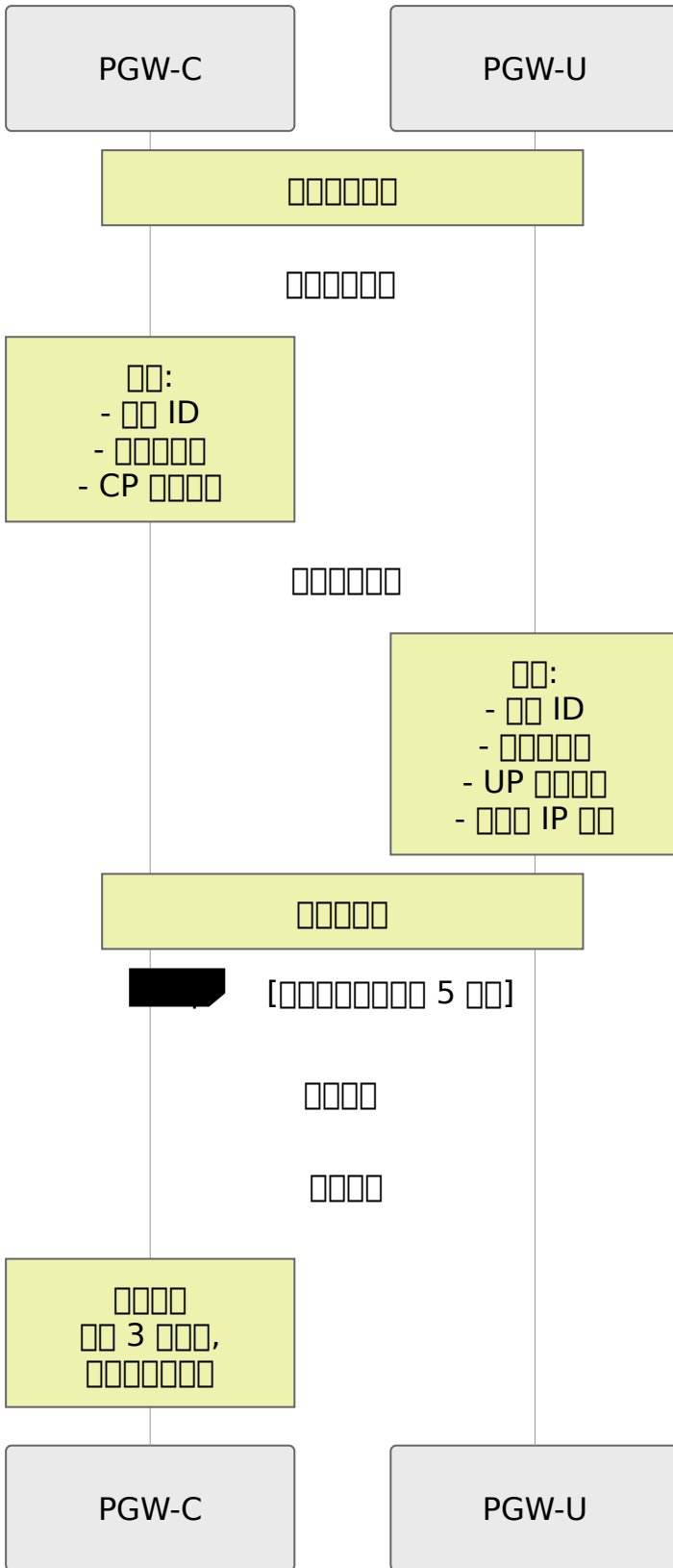

□□□□□□□□

□□ PFCP □□□□□□□□

| □□                            | □□                      |
|-------------------------------|-------------------------|
| is_associated                 | □□□□□□□□□□              |
| remote_node_id                | □□□□□□ ID □ IP □ FQDN □ |
| remote_ip_address             | □□□□□ IP □□             |
| remote_port                   | UDP □□□□□ 8805 □        |
| heartbeat_period_ms           | □□□□□□□□                |
| missed_heartbeats_consecutive | □□□□□□□□                |
| up_function_features          | □□□□□□□□                |
| up_recovery_time_stamp        | □□□□□□□□□□              |

□□□□

□□□ □□□□□□□□□□□□□□□□

□□□

```
config/runtime.exs
sxb: %{
 local_ip_address: "10.0.0.20"
},
upf_selection: %{
 fallback_pool: [
 %{remote_ip_address: "10.0.0.21", remote_port: 8805, weight:
100}
]
}
UPF 5
```

配置

- 配置 `missed_heartbeats_consecutive` 为 1
- 配置 3
- 配置

## PFCP 配置

PFCP 配置 UE PDN 配置

□□□□□□

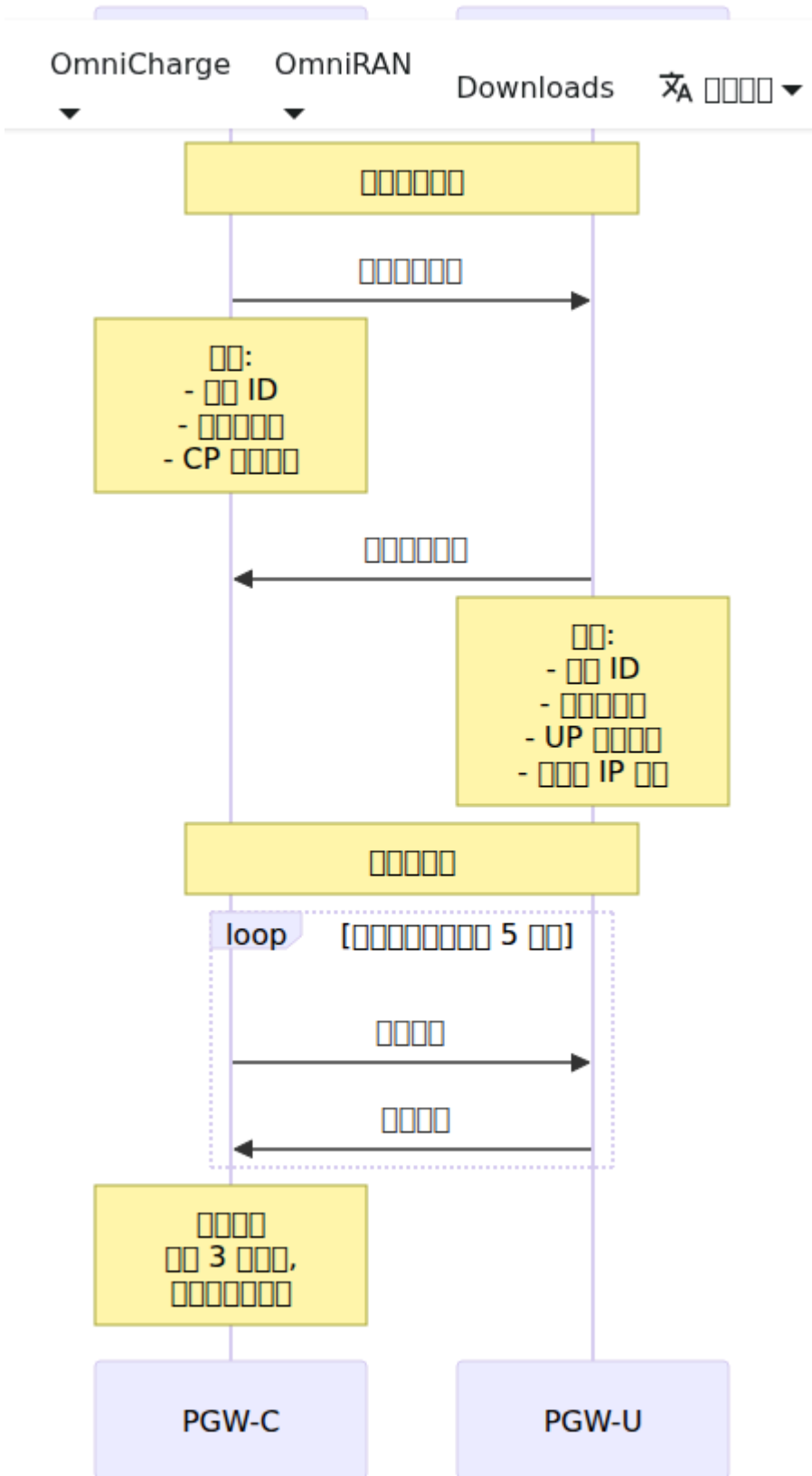

□□□□

□□□ UE □□□□□ PDN □□

### PGW-C □□□ PGW-U□

□□□□□□ □□□

- **SEID**□□□□□ ID□ - □□□□□□□□
- □□ **ID** - PGW-C □□□ ID
- **F-SEID** - □□□□□ SEID□□□□ IP + SEID□
- **PDRs** - □□□□□□□□□□ 2 □□□□ + □□□
- **FARs** - □□□□□□□□□□ 2 □□□□ + □□□
- **QERs** - QoS □□□□□□□□□□□□
- **BAR** - □□□□□□□□□□□□□□

### PGW-U □□□

□□□□□□ □□□

- □□ - □□□□□□□□
- **F-SEID** - PGW-U □□□□□□
- □□□ **PDRs** - □□□□□□□□□
- **F-TEID** - S5/S8 □□□□□□□□ TEID

□□□□

□□□ QoS □□□□□□□□□□□□□□□□

□□□□□□□□

- □□□□□ PDRs□FARs□QERs
- □□□□□□□□
- □□□□□□□□





- 1x UPF
- 1x UPF 1x PGW-C
- 1x
- 3GPP PFCP

1x

- 1x UPF 1x CHOOSE
- 1x "IE" UPF 1x CHOOSE

### PGW-C

1x

```
sxb: %{
 allocate_uplink_f_teid: true
}
```

1x

1. PGW-C TEID
2. PGW-C TEID 1x PFCP
3. UPF TEID
4. PGW-C 1x UPF TEID

1x

### 1x UPF 1x CHOOSE

- 1x UPF /
- UPF 1x PFCP TEID
- 

### 1x TEID

- PGW-C TEID
- PGW-C TEID
- TEID



- □□□□□□□□ TEID

□□□□

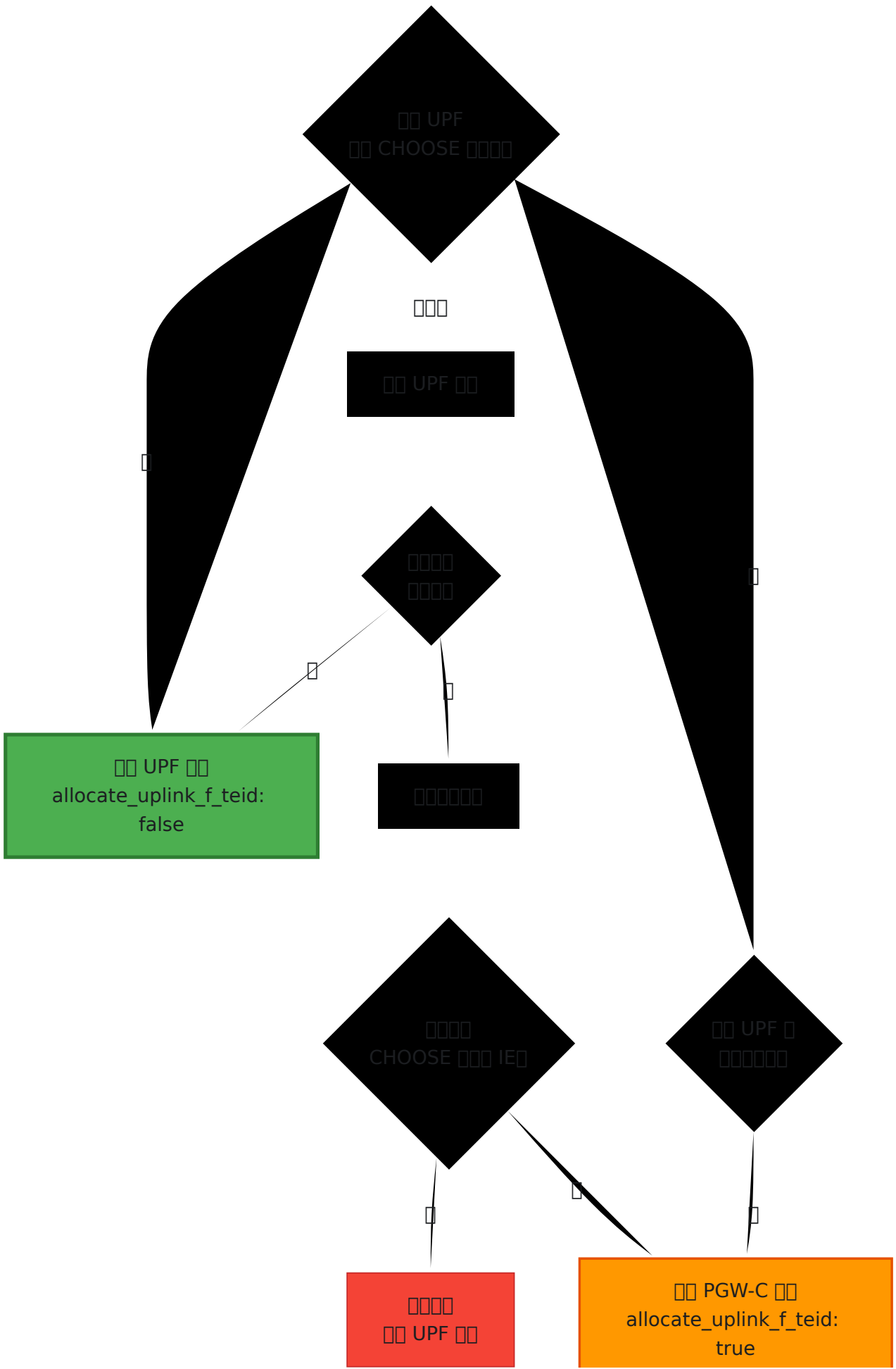

□□□□

□□□□□□□□□□

□□ PFCP □□□

```
□□ CHOOSE □□□□□
grep -i "choose\|mandatory.*missing" /var/log/pgw_c.log

□□ PFCP □□□□□□□□□□
grep "Session Establishment Response" /var/log/pgw_c.log
```

□□ **UPF** □□ **CHOOSE** □□□

- □□□□□□“□□□□ IE”□“□□ IE”
- UPF □□□□ F-TEID□□□□□ CHOOSE
- □□□□□ □□ `allocate_uplink_f_teid: true`

□□ **PGW-C** □□□□□□□

- □□□□ - TEID □□□□□40 □□□□
- □□ TEID □□□□□□□□□□□□□□□□□□

```
□□□□□□□
grep "registered_teid_count" /var/log/pgw_c.log
```

□□□□□□□□

```
□□ config/runtime.exs
sxb: %{
 local_ip_address: "10.0.0.20",
 allocate_uplink_f_teid: false # □□ UPF □□□ CHOOSE□□□□□ true
}
```

□□□□ PGW-C□

```
systemctl restart pgw_c
```

PFCP

```
PFCP
tcpdump -i any -n port 8805 -w pfcp.pcap

Wireshark
F-TEID "CHOOSE"UPF
F-TEID TEID PGW-C
```

PFCP

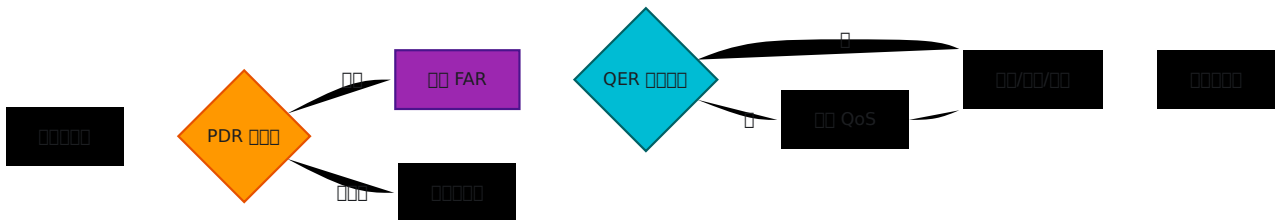

**PDR**

**PGW-C**

**PDR #1** -

PDR ID: 1  
QoS: 100  
PDI: [redacted]  
- [redacted] CORE [redacted]  
- UE IP [redacted] 100.64.1.42/32  
FAR ID: 1 [redacted]

## PDR #2 - [redacted]

PDR ID: 2  
QoS: 100  
PDI: [redacted]  
- [redacted] ACCESS [redacted] SGW [redacted]  
- F-TEID: <S5/S8 [redacted]>  
FAR ID: 2 [redacted]  
QER ID: 1 [redacted] QoS [redacted]

## [redacted] PDR [redacted]

- **PDR ID** - [redacted]
- **QoS** - [redacted]
- **PDI** - [redacted] IP [redacted] TEID [redacted]
- **[redacted]** - [redacted] GTP-U [redacted]
- **FAR ID** - [redacted]
- **QER ID** - [redacted] QoS [redacted]

## FAR [redacted]

[redacted] [redacted]

**FAR #1** - [redacted] → UE [redacted]



QER ID: 1

□□□□□□

□□□□□□

- □□□100 Mbps

- □□□50 Mbps

□□□□□□□□□□□□ GBR □□□

- □□□10 Mbps

- □□□10 Mbps

## □□ QER □□□

- **QER ID** - □□□□□□□□
- □□□ - □□□□□□□□□□□□□□
- **MBR** - □□□□□□□□/□□□
- **GBR** - □□□□□□□□□□□□□□
- **QCI** - QoS □□□□□□□□□□□□

## BAR□□□□□□□□□□

□□□ □□ UE □□□□□□□□□□□□□□□□

## □□ BAR□

BAR ID: 1

□□□□□□□□□□100ms

□□□□□□□□□□10

□□□ □□□□ DRX□□□□□□□□□□

□□

## □□ Sxb □□

□□ `config/runtime.exs`□

```

config :pgw_c,
 sxb: %{
 # PFCP IP
 local_ip_address: "10.0.0.20",

 # PFCP Port 8805
 local_port: 8805,

 # PFCP Timeout 500ms
 # UPF
 # UPF request_timeout_ms: 500,
 request_timeout_ms: 500,

 # PFCP Retries 3
 # request_attempts = request_timeout_ms * request_attempts
 request_attempts: 3,

 # F-TEID
 # false UPF F-TEID CHOOSE
 # true PGW-C F-TEID
 # UPF CHOOSE
 allocate_uplink_f_teid: false
 },

 # UPF - UPF
 upf_selection: %{
 fallback_pool: [
 %{
 # PGW-U IP
 remote_ip_address: "10.0.0.21",

 # PFCP Port 8805
 remote_port: 8805,

 # Weight 100 = 1000 = 100
 weight: 100
 }
]
 }
}

```

□□□□□□

PCFP □□□□□□□□□□□□ UPF □□□□□□□□□□□□

□□□

| □□                              | □□ | □□□ | □□                    |
|---------------------------------|----|-----|-----------------------|
| <code>request_timeout_ms</code> | □□ | 500 | □□ UPF □□□□□□□□□□□□□□ |
| <code>request_attempts</code>   | □□ | 3   | □□□□□□□□□□□□□□□□      |

□□□□□□ `request_timeout_ms × request_attempts`

□□□□□ 500ms  $\times \times$  3 □□□ = □□□□□ **1.5** □

□□□□□□□□□□

□□ `request_timeout_ms` □□□□□□ UPF □□□□□□□□

1. PGW-C □□□□□□□□□□
2. □□□ UPF □□□□□□□□
3. PGW-C □□□□□□□□□□
4. UPF □□□□□□□□□□ □□ **PCFP** □□
5. PGW-C □□□□□□□□□□□□□□ ID
6. □□□□□□ UPF □□□ □□□

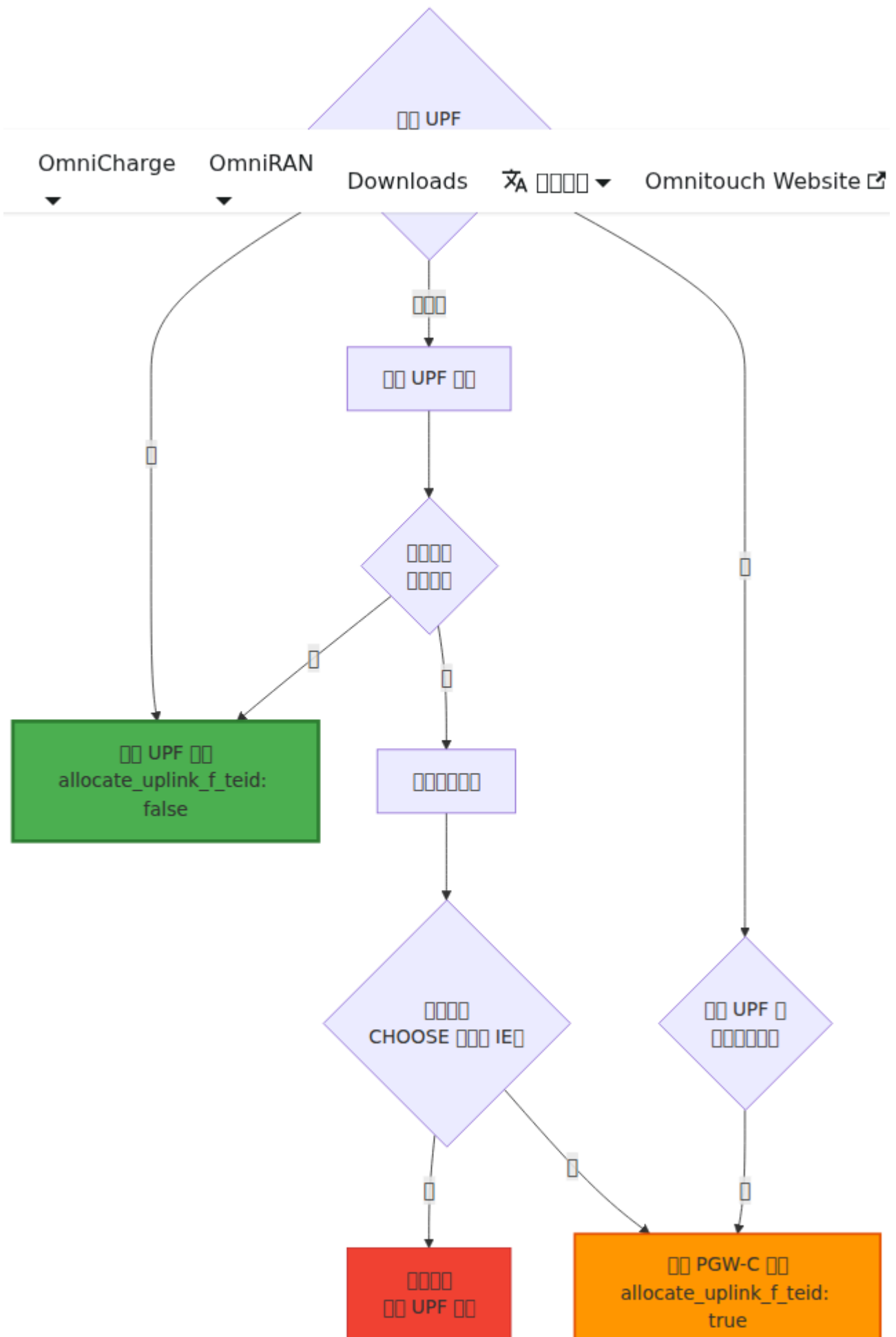



1. `request_timeout_ms` `UPF`
2. `PGW-C`
3. `UPF`

## `PGW-U`

```
config :pgw_c,
 sxb: %{
 local_ip_address: "10.0.0.20"
 },
 upf_selection: %{
 fallback_pool: [
 %{remote_ip_address: "10.0.1.21", remote_port: 8805, weight:
50}, # 50%
 %{remote_ip_address: "10.0.2.21", remote_port: 8805, weight:
50} # 50%
]
 }
UPF 5
```

# UPF 配置

PGW-C 側の UPF 設定

1. 設定項目 - 設定値
2. DNS 設定 - DNS NAPTR 設定
3. 設定項目 - 設定値 UPF 側

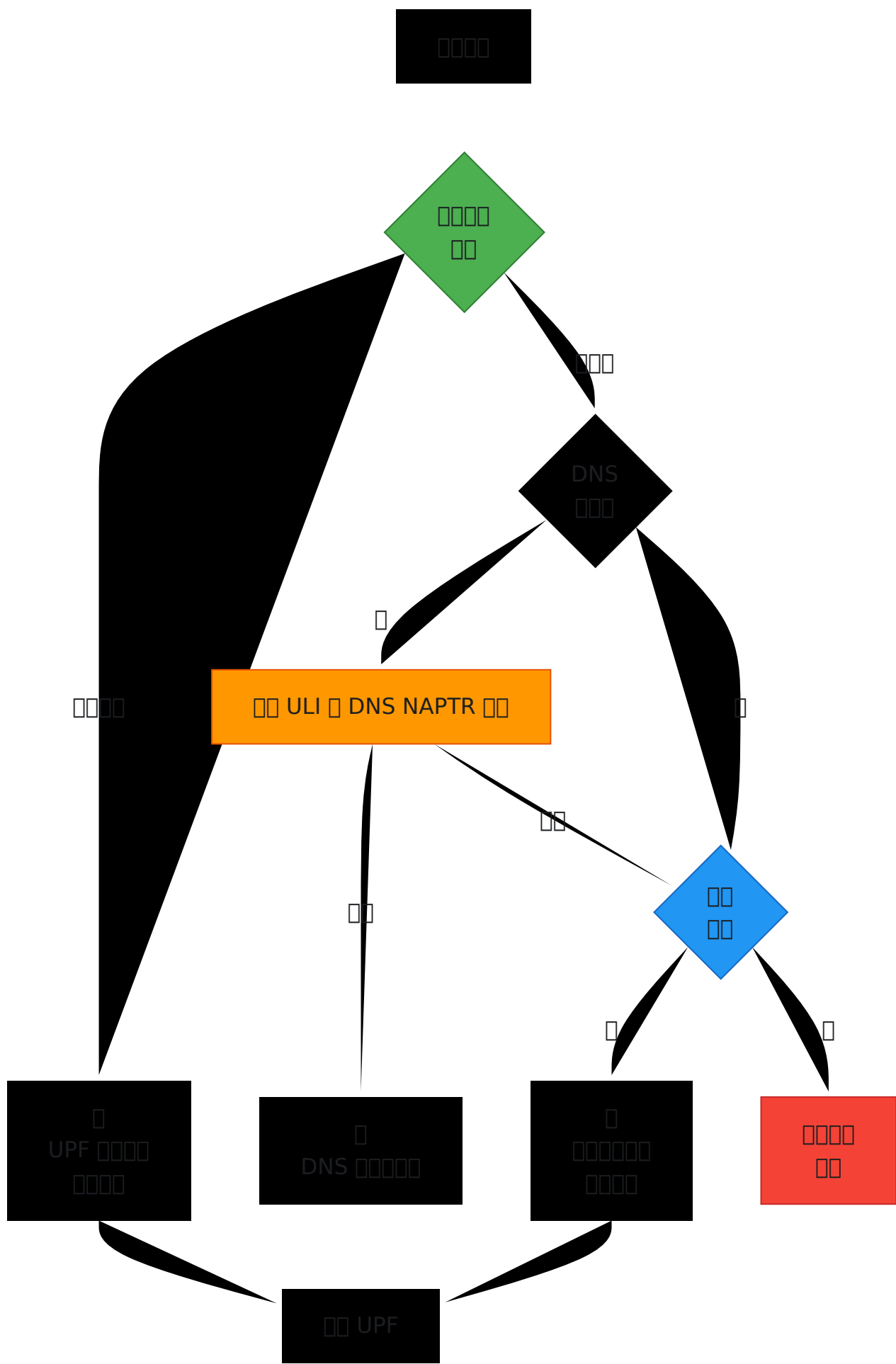



□□□ **UPF** □□□□

```

config :pgw_c,
 # PFCP []
 sxb: %{
 local_ip_address: "10.0.0.20"
 },

 # UPF [] UPF []
 upf_selection: %{
 #
=====

 # [] DNS []
 #

=====

 # []ULI[] DNS
 # [] UPF []
 dns_enabled: false,
 dns_query_priority: [:ecgi, :tai, :rai, :sai, :cgi],
 dns_suffix: "epc.3gppnetwork.org",
 dns_timeout_ms: 5000,

 #

=====

 # []
 #

=====

 # []
 # [] UPF []
 rules: [
 # [] 1[]IMS [] - []
 %{
 name: "IMS []",
 priority: 20,
 match_field: :apn,
 match_regex: "^ims",
 upf_pool: [
 weight: 80,
 %{remote_ip_address: "10.100.2.21", remote_port: 8805,
 weight: 20}
 %{remote_ip_address: "10.100.2.22", remote_port: 8805,
],
 # [] PCO []
 pco: %{
 p_cscf_ipv4_address_list: ["10.101.2.100", "10.101.2.101"]
 }
]
 }

```

```

 }
 },

 # 2 APN -
 %{
 name: "",
 priority: 15,
 match_field: :apn,
 match_regex: "^(enterprise|corporate)\.apn",
 upf_pool: [
 weight: 100}
 %{remote_ip_address: "10.100.3.21", remote_port: 8805,
],
 pco: %{
 primary_dns_server_address: "192.168.1.10",
 secondary_dns_server_address: "192.168.1.11",
 ipv4_link_mtu_size: 1500
 }
 },

 # 3 -
 %{
 name: "",
 priority: 10,
 match_field: :serving_network_plmn_id,
 match_regex: "^(310|311|312|313)", #
 upf_pool: [
 weight: 100}
 %{remote_ip_address: "10.100.4.21", remote_port: 8805,
]
 },

 # 4 -
 %{
 name: "",
 priority: 5,
 match_field: :apn,
 match_regex: "^internet",
 upf_pool: [
 weight: 33},
 weight: 33},
 weight: 33},
 %{remote_ip_address: "10.100.1.21", remote_port: 8805,
 %{remote_ip_address: "10.100.1.22", remote_port: 8805,
 %{remote_ip_address: "10.100.1.23", remote_port: 8805,

```

```

weight: 34}
]
}
],

#
=====

#
=====
DNS
fallback_pool: [
 %{remote_ip_address: "127.0.0.21", remote_port: 8805, weight:
100}
]
}

```

□□□□□□

| □□□□                     | □□                     | □□□                |
|--------------------------|------------------------|--------------------|
| :imsi                    | □□□□□□□□               | "310260123456789"  |
| :apn                     | □□□□□                  | "internet" □ "ims" |
| :serving_network_plmn_id | □□□□ PLMN<br>□MCC+MNC□ | "310260" □□□□□□□   |
| :sgw_ip_address          | SGW IP □□□□□□□□        | "10.0.1.50"        |
| :uli_tai_plmn_id         | □□□ PLMN ID            | "310260"           |
| :uli_ecgi_plmn_id        | E-UTRAN □□ PLMN ID     | "310260"           |

**UPF** □□□□□

□□□□□□□□□□ **UPF** □□□□□□□□□□□□

```
upf_pool: [
 {%remote_ip_address: "10.100.1.21", remote_port: 8805, weight:
50},
 {%remote_ip_address: "10.100.1.22", remote_port: 8805, weight:
30},
 {%remote_ip_address: "10.100.1.23", remote_port: 8805, weight:
20}
]
```

□□□□□□□□□□

1. □□□□□□50 + 30 + 20 = 100
2. □□□□□□0.0 □ 100.0
3. □□□□□□□□□□ UPF□
  - 0-50□UPF-1□50% □□□
  - 50-80□UPF-2□30% □□□
  - 80-100□UPF-3□20% □□□

□□□

- □□□□□ □□□□□□□□33□33□34□
- □/□□ □□□□□80□□□□□□□□□20□
- □□□□□ □□□ UPF □□□□□

**PCO** □□

□□□□□□ PCO□□□□□□□□□□□□

```

%{
 name: "IMS 00",
 match_field: :apn,
 match_regex: "^ims",
 upf_pool: [...],
 pco: %{
 # 00000000
 p_cscf_ipv4_address_list: ["10.101.2.100", "10.101.2.101"],
 # 00000000 PCO 00000000
 }
}

```

### 000 PCO 000000

- primary\_dns\_server\_address
- secondary\_dns\_server\_address
- primary\_nbns\_server\_address
- secondary\_nbns\_server\_address
- p\_cscf\_ipv4\_address\_list
- ipv4\_link\_mtu\_size

### 00 DNS 000

0000 PGW-C 000000000000 DNS NAPTR 000

```

upf_selection: %{
 dns_enabled: true,
 dns_query_priority: [:ecgi, :tai, :rai, :sai, :cgi],
 dns_suffix: "epc.3gppnetwork.org",
 dns_timeout_ms: 5000
}

```

### 000000

1. **ECGI** E-UTRAN 0000000000 - 000
2. **TAI** 0000000000 - 0000
3. **RAI** 0000000000 - 3G/2G 00
4. **SAI** 0000000000 - 3G 0000

## 5. CGI - 2G

### DNS

```
ECGI
eci-1a2b3c.ecgi.epc.mnc999.mcc999.epc.3gppnetwork.org

TAI
tac-lb64.tac-hb00.tac.epc.mnc999.mcc999.epc.3gppnetwork.org
```

### DNS

- ECGI TAI
- DNS
- UPF
- DNS DNS

DNS UPF

---

## DNS UPF

DNS UPF UE ULI DNS NAPTR

3GPP TS 23.003 - UPF DNS

- UPF
- 
- 
- UPF



□□□ - LTE □□□□□

□□□

```
eci-<HEX-ECI>.ecgi.epc.mnc<MNC>.mcc<MCC>.<dns_suffix>
```

□□□

```
□□ ID: 0x1A2B3C□1,715,004 □□□□
PLMN: MCC=999, MNC=999
eci-1a2b3c.ecgi.epc.mnc999.mcc999.epc.3gppnetwork.org
```

□□□□□ LTE□4G□□□□

## 2. TAI□□□□□□□□□□

□□□□ - □□□□□□□□□□□□□□

□□□

```
tac-lb<LB>.tac-hb<HB>.tac.epc.mnc<MNC>.mcc<MCC>.<dns_suffix>
```

□□□

```
TAC: 0x0064□100 □□□□
□□□: 0x64□□□□: 0x00
tac-lb64.tac-hb00.tac.epc.mnc999.mcc999.epc.3gppnetwork.org
```

□□□□□ LTE□4G□□□□□

## 3. RAI□□□□□□□□□□

**3G/2G** □□□□

□□□

```
rac<RAC>.lac-lb<LB>.lac-hb<HB>.lac.raimnc<MNC>.mcc<MCC>.
<dns_suffix>
```

□□□

```
RAC: 0x0A10 □□□□
LAC: 0x12344660 □□□□
rac0a.lac-lb34.lac-hb12.lac.raimnc999.mcc999.epc.3gppnetwork.org
```

□□□□ 3G/2G UMTS/GPRS □□

#### 4. SAI□□□□□□□□

**3G** □□□□

□□□

```
sac<SAC>.lac-lb<LB>.lac-hb<HB>.lac.saimnc<MNC>.mcc<MCC>.
<dns_suffix>
```

□□□

```
SAC: 0x0001
LAC: 0x1234
sac0001.lac-lb34.lac-
hb12.lac.saimnc999.mcc999.epc.3gppnetwork.org
```

□□□□ 3G UMTS □□□□

#### 5. CGI□□□□□□□□

**2G** □□□

□□□

```
ci<CI>.lac-lb<LB>.lac-hb<HB>.lac.cgi.mnc<MNC>.mcc<MCC>.
<dns_suffix>
```

□□□

```
CI: 0x5678
LAC: 0x1234
ci5678.lac-lb34.lac-hb12.lac.cgi.mnc999.mcc999.epc.3gppnetwork.org
```

□□□□□ 2G GSM □□

## DNS □□□□

### NAPTR □□□□□

DNS □□ NAPTR □□□□□ UPF IP □□□

```
eci-1a2b3c.ecgi.epc.mnc999.mcc999.epc.3gppnetwork.org.
 IN NAPTR 10 50 "a" "x-3gpp-upf:x-s5-gtp:x-s8-gtp" ""
upf1.epc.mnc999.mcc999.3gppnetwork.org.

upf1.epc.mnc999.mcc999.3gppnetwork.org.
 IN A 10.100.1.21
```

### PGW-C □□□

1. □□ NAPTR □□□□□ UPF IP □□
2. □ DNS □□□□□□□□□□□
3. □□□□□□□□□□□□□□□□□□□□

□□□

```
DNS □□: [10.100.1.21, 10.100.5.99]
```

```
□□: 10.100.1.21□□□□□□□□
□□: □□ upf_selection □□□□□□□□□
```

□□□□□□□□

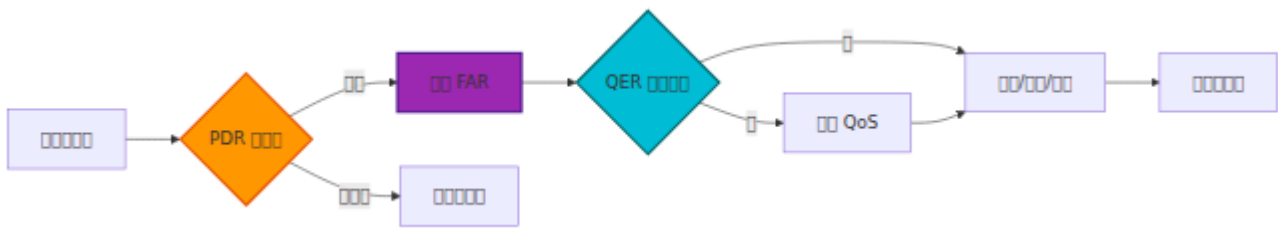

□□

### 1. □□□□□□

□□□ □□□□□□□□□□ UPF

#### DNS □□□

```
□□□□□□
eci-aaa.ecgi.epc.mnc999.mcc999.epc.3gppnetwork.org → UPF-□□□
□10.1.1.21□

□□□□□
eci-bbb.ecgi.epc.mnc999.mcc999.epc.3gppnetwork.org → UPF-□□
□10.2.1.21□

□□□□□□
eci-ccc.ecgi.epc.mnc999.mcc999.epc.3gppnetwork.org → UPF-□□□
□10.3.1.21□
```

□□□ □□□□□□□□□□ UPF□□□□□□□□□□

### 2. □□□□□

□□□ □□□□□□□□□□ MEC□□□□□□□□□□UPF

#### DNS □□□

```
□□□□□□□□□□ UPF
eci-*.ecgi.epc.mnc999.mcc999.epc.3gppnetwork.org → □□□□ UPF
```

DNS 設定

### 3. DNS 設定

DNS 設定は UPF 設定

DNS 設定は PGW-C 設定

## DNS 設定

### DNS 設定

設定

- DNS UPF 設定: `nxdomain`
- DNS 設定

設定

1. DNS 設定
2. DNS 設定 ID
3. GTP-C 設定 ULI

設定

```
DNS 設定
dig eci-1a2b3c.ecgi.epc.mnc999.mcc999.epc.3gppnetwork.org NAPTR

PGW-C 設定 DNS 設定
grep "DNS UPF selection: querying" /var/log/pgw_c.log

ULI 設定
"uli" 設定
```

### DNS 設定 UPF







設定

- DNS 設定 UPF 設定 `upf_selection`
- DNS 設定

-  PFCP  UPF 
-  PFCP 



```
DNS : [10.99.1.50]
upf_selection: [10.100.1.21, 10.100.1.22]
```

```
:  10.99.1.50
-  PFCP 
- 
- 
```



1.  `upf_selection` 

```
upf_selection: %{
 fallback_pool: [
 %{remote_ip_address: "10.99.1.50", remote_port: 8805, weight:
100}
]
}
```

2.  DNS  UPF IP

3.  MEC/





-  "DNS UPF 
- 



```
upf_selection: %{\n dns_timeout_ms: 10000 # 10 seconds\n}
```

## DNS

```
DNS success rate\nrate(upf_selection_dns_success_total[5m]) /\nrate(upf_selection_dns_attempts_total[5m])\n\n# DNS 95th percentile duration\nhistogram_quantile(0.95,\nrate(upf_selection_dns_duration_seconds_bucket[5m]))\n\n# DNS fallback rate\nrate(upf_selection_fallback_used_total[5m])
```

```
[debug] DNS UPF selection: querying eci-1a2b3c.ecgi.epc.mnc999.mcc999.epc.3gppnetwork.org\n[debug] DNS UPF selection: got 2 candidates from DNS\n[info] DNS UPF selection: selected 10.100.1.21
```

---

□□□

□□□□□□□

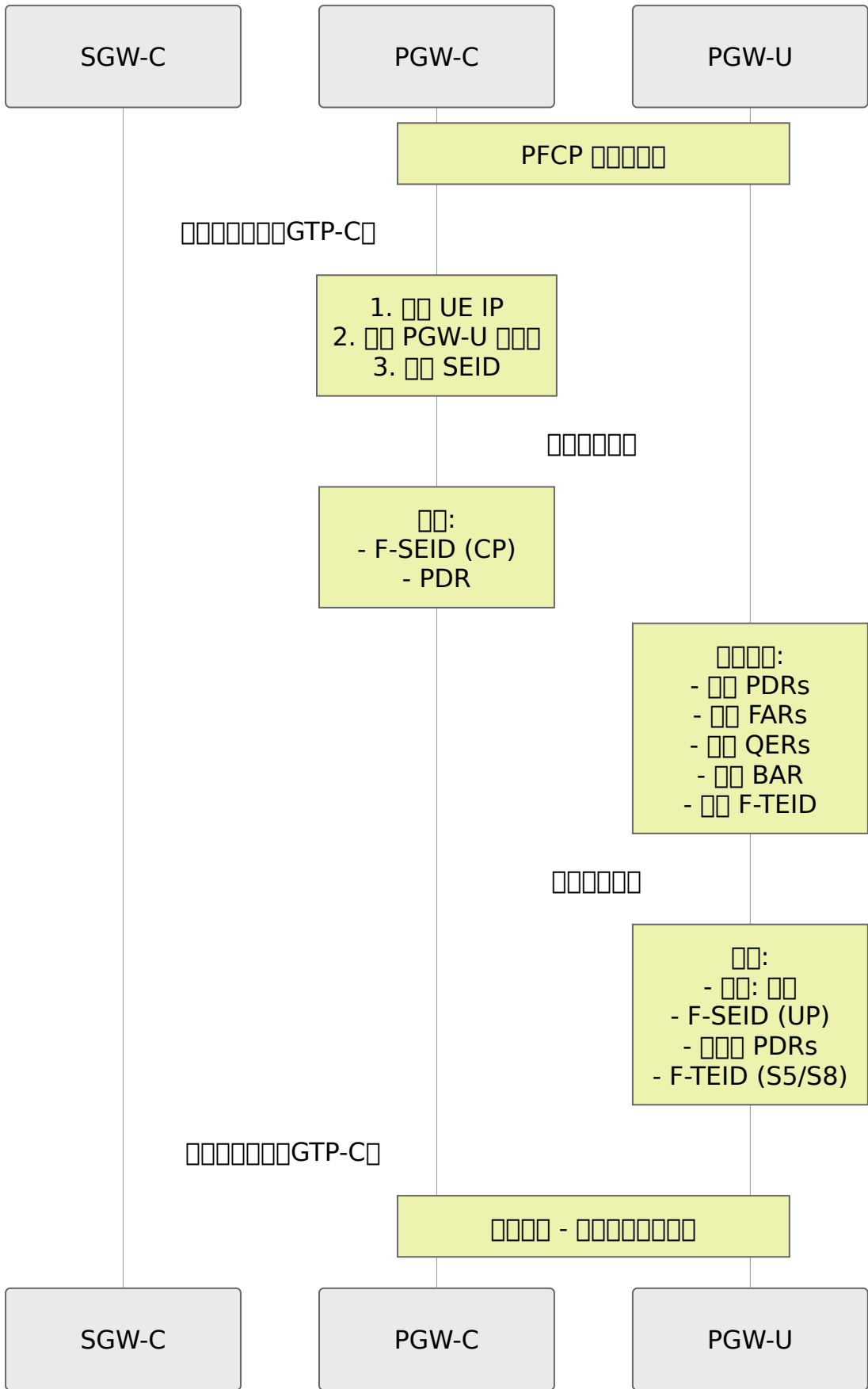

□□□□□

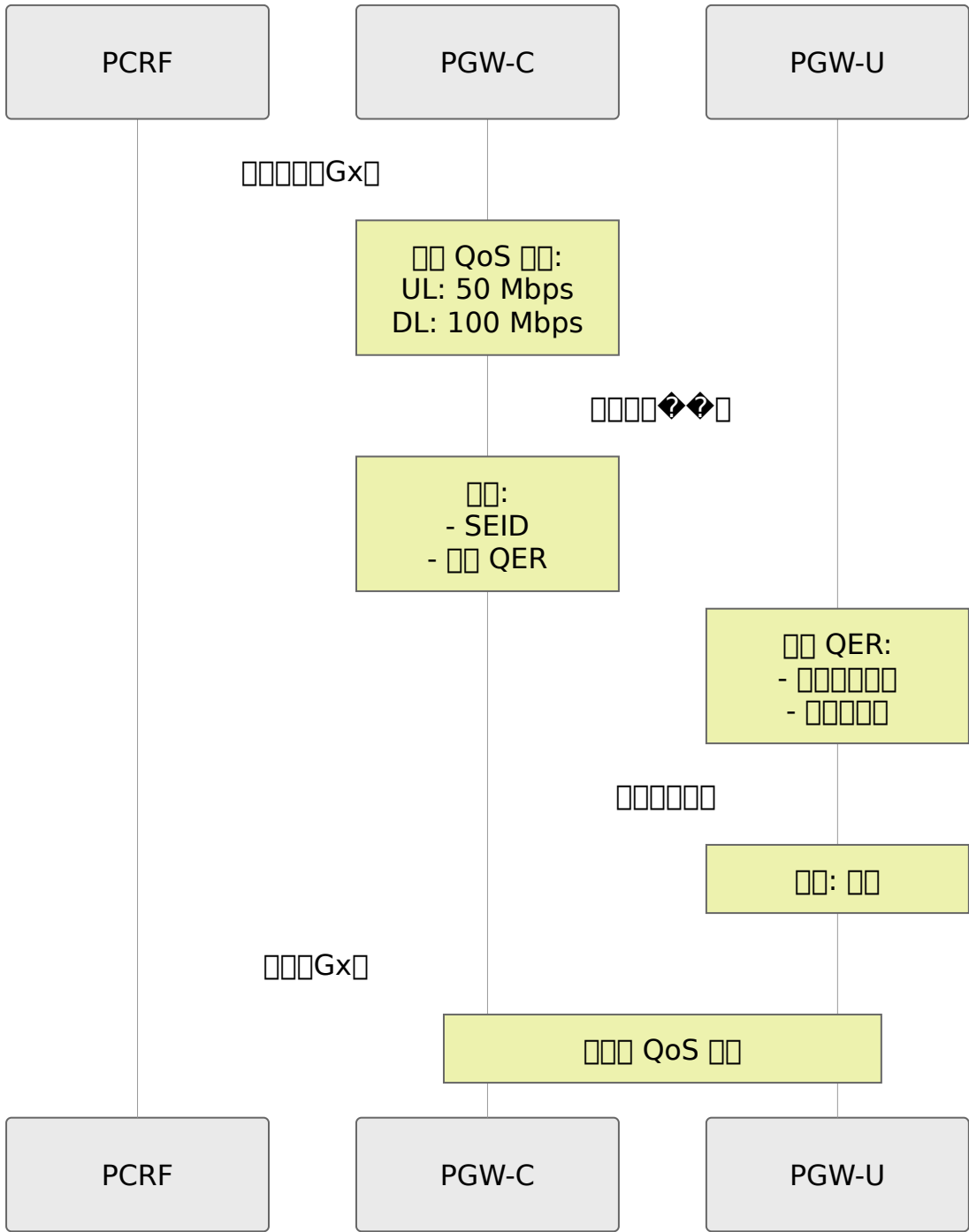

□□□□□

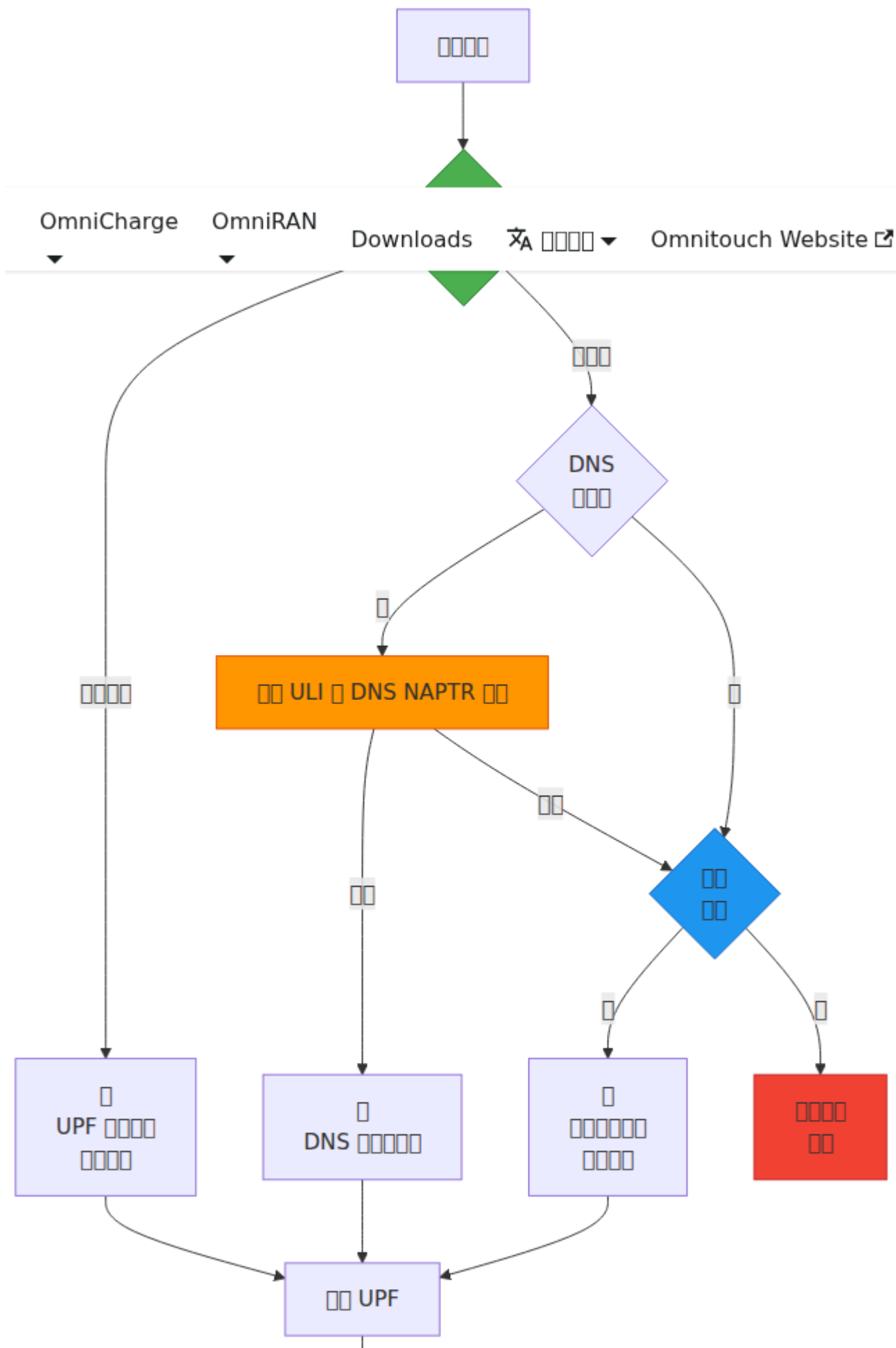

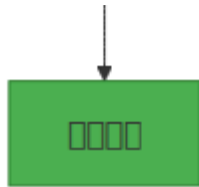

PGW-U

PGW-U

## 1. PGW-U

PGW-U

- PGW-U "PCF-PFCP" (PGW-U PCF-PFCP)
- PGW-U PCF-PFCP (PGW-U PCF-PFCP)

PGW-U

- PGW-U PCF-PFCP (PGW-U PCF-PFCP)
- PGW-U PCF-PFCP (PGW-U PCF-PFCP)
- PGW-U UDP 8805 (PGW-U UDP 8805)
- PGW-U `remote_ip_address` (PGW-U `remote_ip_address`)

PGW-U

```
PGW-U
ping <pgw_u_ip_address>

UDP 8805
nc -u -v <pgw_u_ip_address> 8805

PGW-U
iptables -L -n | grep 8805
```

## 2. PGW-U

PGW-U



- SEID 00000000
- PGW-U 00000 PGW-C 00

00000

- 0000 PFCP 0000000000000000
- PGW-C 0000 PGW-U 000000000000

## 00 **PFCP** 00

000000

```
PFCP 00000000
pfcpeer_associated{peer="PGW-U Primary"} 1

00 PFCP 00
seid_registry_count 150

PFCP 0000
rate(sxb_inbound_messages_total[5m])

PFCP 00
rate(sxb_inbound_errors_total[5m])

0000
pfcpeer_consecutive_heartbeat_failures{peer="PGW-U Primary"} 0
```

00000

```
PFCP Peer Down
- alert: PFCPAssociationDown
 expr: pfcpeer_associated == 0
 for: 1m
 annotations:
 summary: "PFCP Peer {{ $labels.peer }} Down"

PFCP Session Establishment Failure High
- alert: PFCPSessionEstablishmentFailureHigh
 expr:
rate(sxb_inbound_errors_total{message_type="session_establishment_res
[5m]) > 0.1
 for: 5m
 annotations:
 summary: "PFCP Session Establishment Failure High"
```

---

## Web UI - PFCP

OmniPGW Web UI PFCP/Sxb

### UPF/PFCP

[http://<omnipgw-ip>:<web-port>/upf\\_status](http://<omnipgw-ip>:<web-port>/upf_status)

PGW-U PFCP

1.

- PFCP
- 
- 2

2. PGW-U

- 
- **IP** - PGW-U IP
- 
- **ID** - PFCP
- 
- 
- 
- **UP** - PGW-U

3.

- `omnipgw`
- `UP` `omnipgw`
- `omnipgw`
- `omnipgw`

## PFCP `omnipgw`

`omnipgw` `http://<omnipgw-ip>:<web-port>/pfcpsessions`

`omnipgw` `omnipgw` OmniPGW `omnipgw` PGW-U `omnipgw` PFCP `omnipgw`

`omnipgw`

### 1. `omnipgw`

- `omnipgw` PFCP `omnipgw`
- `omnipgw`

### 2. `omnipgw` `omnipgw` PFCP `omnipgw`

- `omnipgw` - `omnipgw`
- `omnipgw` ID - `omnipgw`



1. 3GPP PGW-U 3GPP
2. 3GPP PCF 3GPP
3. 3GPP PCRF 3GPP
4. 3GPP PCRF 3GPP

## 3GPP

- 3GPP UPF 3GPP
- 3GPP “3GPP” 3GPP
- 3GPP 3GPP 3GPP
- 3GPP Web UI 3GPP

## 3GPP

- 3GPP - 3GPP SSH
- 3GPP - 3GPP/3GPP
- 3GPP - 3GPP
- 3GPP - 3GPP PDRs/FARs/QERs 3GPP
- 3GPP - 3GPP

## 3GPP

## 3GPP

- 3GPP - UPF 3GPP PCF 3GPP
- 3GPP - PDN 3GPP

## 3GPP

- **Diameter Gx** 3GPP - 3GPP PCF QoS 3GPP PCC 3GPP
- **Diameter Gy** 3GPP - 3GPP URRCs 3GPP
- **3GPP CDR** 3GPP - 3GPP PCF 3GPP CDR
- 3GPP - PCF 3GPP UPF 3GPP

□□□□

- **S5/S8** □□ - □□□□□□
  - **UE IP** □□ - □□ PFCP □□ UE □□□□
- 

□□□□□□

# QoS

## QoS

PGW-C QoS

- **Gx (Diameter)** - PCRF QoS
- **S5/S8 (GTP-C)** - SGW-C
- **Sxb (PFCP)** - QoS PGW-U

## Sequence

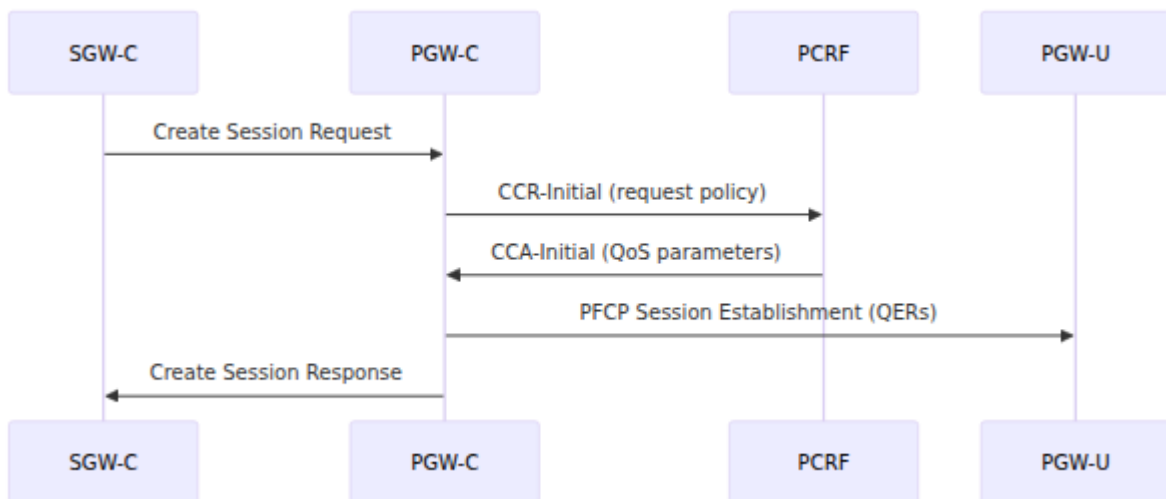

## QoS

- UE: UE PDR/FAR/QER/BAR AMBR
- EBI: EBI (EPS ID) PDR/FAR QER
- **QER (QoS)**: MBR/GBR
- PDN: PDN
- PCRF: PCRF QoS

□□

## □□□□: □□ **QoS** □□

□□ QoS □□□□ Diameter Gx □□□□□□□□ PCRF□□□□ PCRF □□□□□□□□□□□□□□□□ OmniHSS□□

□□□□ `config/runtime.exs` □□□□ **PCRF** □□□□

```
config :pgw_c,
 diameter: %{
 listen_ip: "0.0.0.0",
 host: "omni-pgw_c.epc.mnc999.mcc999.3gppnetwork.org",
 realm: "epc.mnc999.mcc999.3gppnetwork.org",
 peer_list: [
 %{
 host: "pcrf.epc.mnc999.mcc999.3gppnetwork.org",
 realm: "epc.mnc999.mcc999.3gppnetwork.org",
 ip: "192.168.1.100",
 initiate_connection: true
 }
]
 }
}
```

**QoS** □□□□□□□□□□□□□□ **PCRF** □□□□□□□□□□ **PGW-C** □□□□□□□□

□□□□□□□□

□□□□□□□□

□□□□□□ PDN □□□□□□□□□□



## Create Session Request

AllocateIP

UE IP assigned

RequestPolicy

CCR-Initial sent to PCRF

CreateBearer

CCA-Initial received  
with QoS

ProgramUPF

PFCP Session  
Establishment

Active

## Delete Session Request



□□□□:

1. SGW-C □□ Create Session Request
2. PGW-C □□□□□□□□ UE IP □□
3. PGW-C □□ CCR-Initial □ PCRF□□□ IMSI□APN□IP □□
4. PCRF □□ CCA-Initial□□□ QoS □□□
  - Default-EPS-Bearer-QoS (QCI, ARP)
  - QoS-Information (AMBR □□)

5. PGW-C 消息

- ID: PDR=1 PDR=2 FAR=1 FAR=2 QER=1 BAR=1
- QER QoS MBR

6. PGW-C 到 PGW-U 的 PFCP Session Establishment Request

7. PGW-C 到 SGW-C 的 Create Session Response

消息:

- PDN
- QCI 5 到 QCI 9 GBR
- EBI
- 

消息

消息 PCRF 消息

消息: 消息 PCRF 的 Re-Auth Request (RAR) 消息 Charging-Rule-Install

消息:

1. PCRF 消息 RAR 消息 Charging-Rule-Definition 消息
  - Charging-Rule-Name (消息)
  - Flow-Information (消息)
  - QoS-Information (QCI, MBR, GBR, ARP)
  - Precedence (消息)
2. PGW-C 消息 PFCP 消息
  - Flow-Information 消息 → 消息 PDR 消息 SDF 消息
  - QoS-Information → 消息 QER 消息 MBR/GBR 消息
  - Flow-Description → IP 5-消息
3. PGW-C 消息 PFCP Session Modification Request 消息 PDRs/FARs/QERs
4. PGW-C 到 SGW-C 的 Create Bearer Request
5. SGW-C 消息 Create Bearer Response 消息

消息 **Charging-Rule-Definition:**

```
Charging-Rule-Name: "video_streaming"
Flow-Information:
 - Flow-Description: "permit in ip from any to 10.0.0.1 5000-6000"
 Flow-Direction: 1 (downlink)
QoS-Information:
 QoS-Class-Identifier: 7
 Max-Requested-Bandwidth-UL: 5000000 (5 Mbps)
 Max-Requested-Bandwidth-DL: 10000000 (10 Mbps)
 Guaranteed-Bitrate-UL: 1000000 (1 Mbps)
 Guaranteed-Bitrate-DL: 2000000 (2 Mbps)
Precedence: 100
Flow-Status: 2 (ENABLED)
```

□□□□

□□ QoS □□□□□□□□□□

- **Gx RAR**□□□□□ Charging-Rule-Definition
- **PFCP Session Modification**□□□□□□□ QERs□□□□□□□□□□ FARs□□□□□□□□ PDRs□□□□□□□□□□

□□□□

□□:

- **Delete Session Request**□SGW □□□ - □□□□□□□□□□□□
- **Re-Auth Request with Charging-Rule-Remove**□PCRF □□□ - □□□□□□□

□□□□:

1. □□□□□□□□□□□□
2. □□□□□□ PDRs/FARs/QERs
3. □ SGW-C □□ Delete Bearer Request□□□□□□ PCRF □□□□
4. □□ PFCP Session Modification□□□□□□□□□□ Session Deletion□□□□□□□□□□

# QoS

## QCI (QoS Class Identifier)

PCRF Gx QoS-Class-Identifier AVP

QCI:

- **QCI 1:** (GBR, 100ms )
- **QCI 2:** (GBR, 150ms )
- **QCI 3:** (GBR, 50ms )
- **QCI 4:** (GBR, 300ms )
- **QCI 5:** IMS (GBR, 100ms ) -
- **QCI 6:** (TCP) (GBR, 300ms )
- **QCI 7:** (GBR, 100ms )
- **QCI 8:** (TCP) YouTube (GBR, 300ms )
- **QCI 9:** (GBR, 300ms )

QCI:

- QCI PCRF QoS IE SGW-C
- PGW-C QCI - QERs MBR/GBR
- QCI
- QCI

## ARP (Allocation-Retention-Priority)

PCRF Allocation-Retention-Priority AVP

ARP:

- : 15
- :
  - 0 =
  - 1 =
- :

- 0 = 00000000
- 1 = 11111111

0000:

- 000000: 1
- 000000: 00 (0)
- 000000: 00 (1)

000000:

- ARP → SGW-C → 00000000 eNodeB
- **PGW-C** 000000 - 000000 eNodeB 0000000000
- 000000000000000000000000
- 00000000000000 10000000000000

## MBR (000000)

00: PCRF 00 Max-Requested-Bandwidth-UL 0 Max-Requested-Bandwidth-DL  
AVPs

00: 000000000000 kbps: bytes / 1000

0000: 000000000000

0000:

- PGW-C 00 QER000 mbr: %Bitrate{ul: kbps\_ul, dl: kbps\_dl}
- QER 00 PFCP 000 PGW-U
- **PGW-U** 0000000000000000
- 00 MBR 00000000

00:

Max-Requested-Bandwidth-UL: 5000000 (5 Mbps)  
Max-Requested-Bandwidth-DL: 10000000 (10 Mbps)

- QER `QER` mbr: {ul: 5000, dl: 10000} kbps
- PGW-U `PGW-U` 5 Mbps `PGW-U`
- PGW-U `PGW-U` 10 Mbps `PGW-U`

## GBR ( )

`QoS`: PCRF `QoS` `Guaranteed-Bitrate-UL` `Guaranteed-Bitrate-DL` AVPs

`QoS`: `QoS` kbps

`QoS`: `QoS` GBR `QoS`

`QoS`:

- `QoS` Charging-Rule-Definition `QoS` GBR `QoS` **GBR** `QoS`
- PGW-U `QoS` QER `QoS`
- `QoS` eNodeB `QoS`
- GBR `QoS` - `QoS`

`QoS`:

Guaranteed-Bitrate-UL: 1000000 (1 Mbps)  
Guaranteed-Bitrate-DL: 2000000 (2 Mbps)

- QER `QER` gbr: {ul: 1000, dl: 2000} kbps
- `QoS` 1 Mbps `QoS` 2 Mbps `QoS`
- `QoS` VoIP `QoS`

`QoS`:

- GBR `QoS`
- `QoS` GBR `QoS`
- `QoS` GBR `QoS`

# AMBR ( )

: PCRF APN-Aggregate-Max-Bitrate-UL APN-Aggregate-Max-Bitrate-DL AVPs

: GBR APN

:

- AMBR GBR
- Create Session Response SGW-C
- eNodeB/SGW
- PGW-C AMBR SGW-C

:

APN-Aggregate-Max-Bitrate-UL: 50000000 (50 Mbps)  
APN-Aggregate-Max-Bitrate-DL: 100000000 (100 Mbps)

- GBR 50 Mbps / 100 Mbps
- MBR
- AMBR UE/APN

:

- HSS/PCRF
- 10 Mbps 100 Mbps
- GBR

(Gx) (PFCP)

PCRF Flow-Status AVP Charging-Rule-Definition

| Flow-Status (Gx)     | Gate-Status (PFCP QER) | Hex      |
|----------------------|------------------------|----------|
| 0 = ENABLED-UPLINK   | ul: OPEN, dl: CLOSED   | 00000000 |
| 1 = ENABLED-DOWNLINK | ul: CLOSED, dl: OPEN   | 00000001 |
| 2 = ENABLED          | ul: OPEN, dl: OPEN     | 00000002 |
| 3 = DISABLED         | ul: CLOSED, dl: CLOSED | 00000003 |
| 4 = REMOVED          | ul: CLOSED, dl: CLOSED | 00000004 |

Hex:

- **DISABLED:** 00000003
- **ENABLED-UPLINK:** 00000000
- **ENABLED-DOWNLINK:** 00000001
- **ENABLED:** 0000

00000000

## Prometheus Hex

Hex:

```

session_registry_count # Hex (IMSI, EBI Hex)
address_registry_count # Hex UE IP
charging_id_registry_count # Hex

```

Gx Hex:

```

gx_inbound_messages_total{message_type="gx_RAR"} # [] PCRF []
[]
gx_outbound_messages_total{message_type="gx_CCR"} # [] PCRF []
[]
gx_outbound_transaction_duration_bucket # [] PCRF []

```

## PCFP []:

```

sxb_outbound_messages_total{message_type="pfcpsessionestablishment_
sxb_outbound_messages_total{message_type="pfcpsessionmodification_r
sxb_outbound_transaction_duration_bucket

```

## [][][]:

```

s5s8_inbound_messages_total{message_type="createsessionrequest"}
[]
s5s8_outbound_messages_total{message_type="createbearerrequest"}
[]

```

## Web UI []

### PGW [] (/pgw\_sessions):

- [] IMSI[]IP []MSISDN [] APN []
- []
- [] QoS [] (QCI, MBR, GBR, AMBR)
- [] (2 [])

### Diameter [] (/diameter):

- PCRF []
- Gx []
- []/[]

### [][] (/logs):

- []

- "Credit Control" CCR/CCA
- "Re-Auth" RAR
- "PFCP" UERs

## Log Output

```
[debug] Sending Credit Control Request: ... # CCR to PCRF
[debug] Handling Credit Control Answer: ... # CCA from PCRF
[debug] Handling Re-Auth Request # RAR from PCRF
[debug] Sending Session Establishment Request # PFCP to PGW-
UERs QERs
[debug] Sending Session Modification Request # PFCP to PGW-
UERs QERs
```

## QoS

### QoS Configuration

1. Web UI → PGW
2. IMSI 999000123456789
- 3.
4. qer\_map

```
qer_id: 1
gate_status: {ul: OPEN, dl: OPEN}
mbr: {ul: 50000, dl: 100000} # kbps
gbr: {ul: 10000, dl: 20000} # kbps nil GBR
```

5. PCRF

### QoS

: QoS



```

5G S-MME inbound messages total / min
rate(s5s8_inbound_messages_total{message_type="create_session_request"
[5m])

5G S-MME outbound messages total / min
rate(s5s8_outbound_messages_total{message_type="create_bearer_request"
[5m])

PCRF RAR messages total / min
rate(gx_inbound_messages_total{message_type="gx_RAR"}[5m])

```

Queries

Queries:

```

UE IP address registry count / min
(address_registry_count / <configured_pool_size>) * 100

Session registry count
session_registry_count

PCRF P95 transaction duration bucket
histogram_quantile(0.95, gx_outbound_transaction_duration_bucket)

```

Queries:

- `config/runtime.exs` `ue.subnet_map`
- TEID 32 bit 40 bit
- 

Queries:

- IP address - 80%
- PCRF -
-

# □□□□

- □□□□ - PDN □□□□□□
- Diameter Gx □□ - PCRF □□□□□□□□
- PFCP □□ - □□□□□□
- □□□□ - □□□□
- □□□□ - □□□□□□□□



- **TEID** - OmniPGW
- **TEID** - SGW-C

TEID

SGW-C → OmniPGW: TEID = OmniPGW TEID

OmniPGW → SGW-C: TEID = SGW-C TEID

TEID

TEID

```
config/runtime.exs
config :pgw_c,
 s5s8: %{
 # S5/S8 IPv4
 local_ipv4_address: "10.0.0.20",

 # IPv6
 local_ipv6_address: nil,

 #
 local_port: 2123,

 # GTP-C 500ms
 # GTP-C
 request_timeout_ms: 500,

 # GTP-C 3
 # = request_timeout_ms * request_attempts
 # 500ms * 3 = 1500ms 1.5
 request_attempts: 3
 }
```

TEID

S5/S8 GTP-C



```
SGW-C GTP-C
iptables -A INPUT -p udp --dport 2123 -s <sgw_network>/24 -j
ACCEPT
```

```
SGW-C GTP-C
iptables -A OUTPUT -p udp --dport 2123 -d <sgw_network>/24 -j
ACCEPT
```

```
SGW-C
ip route add <sgw_network>/24 via <gateway_ip> dev eth0
```

S5/S8 PDN GTP-C

SGW-C → OmniPGW

PDN

IEs

| IE 名称  | 长度 | 值               |
|--------|----|-----------------|
| IMSI   | 16 | 310260123456789 |
| MSISDN | 10 | 14155551234     |
| APN    | 16 | internet        |
| RAT 类型 | 1  | EUTRAN          |
| QoS 参数 | 1  | QoS 参数          |
| UE 名称  | 16 | UE 名称           |
| ULI    | 16 | TAI/ECGI        |
| PLMN   | 6  | MCC/MNC         |

配置

```

配置参数
├─ IMSI: 310260123456789
├─ MSISDN: 14155551234
├─ APN: internet
├─ RAT 类型: EUTRAN (6)
├─ QoS 参数
│ └─ EBI: 5
│ └─ QoS (QCI 9, ARP, 16)
│ └─ S5/S8 F-TEID (SGW-U 地址)
└─ ULI
 └─ TAI: MCC 310, MNC 260, TAC 12345
 └─ ECGI: MCC 310, MNC 260, ECI 67890

```

配置

配置 OmniPGW → SGW-C

配置 配置

IEs

| IE  |    |             |
|-----|----|-------------|
|     |    |             |
|     |    |             |
| PDN | IP | UE IP UE IP |
| APN |    | APN         |
| PCO |    | PCO         |

```

 (16)
 PDN
 IPv4: 100.64.1.42
 EBI: 5
 S5/S8 F-TEID (PFCP PGW-U)
 APN : Public-1 (1)
 PCO
 DNS : 8.8.8.8
 DNS : 8.8.4.4
 MTU: 1400

```

SGW-C → OmniPGW

PDN

IEs

| IE  |        |
|-----|--------|
| EBI | EPS ID |
| EBI |        |

OmniPGW → SGW-C

**IEs**

| IE |  |
|----|--|
|    |  |

OmniPGW → SGW-C

PCRF

- PCRF PCC
- OmniPGW SGW-C

OmniPGW → SGW-C → SGW-C → OmniPGW

- **PGW** 与 PCRF 交互
- **SGW** 与 PGW 交互

UE

eNodeB

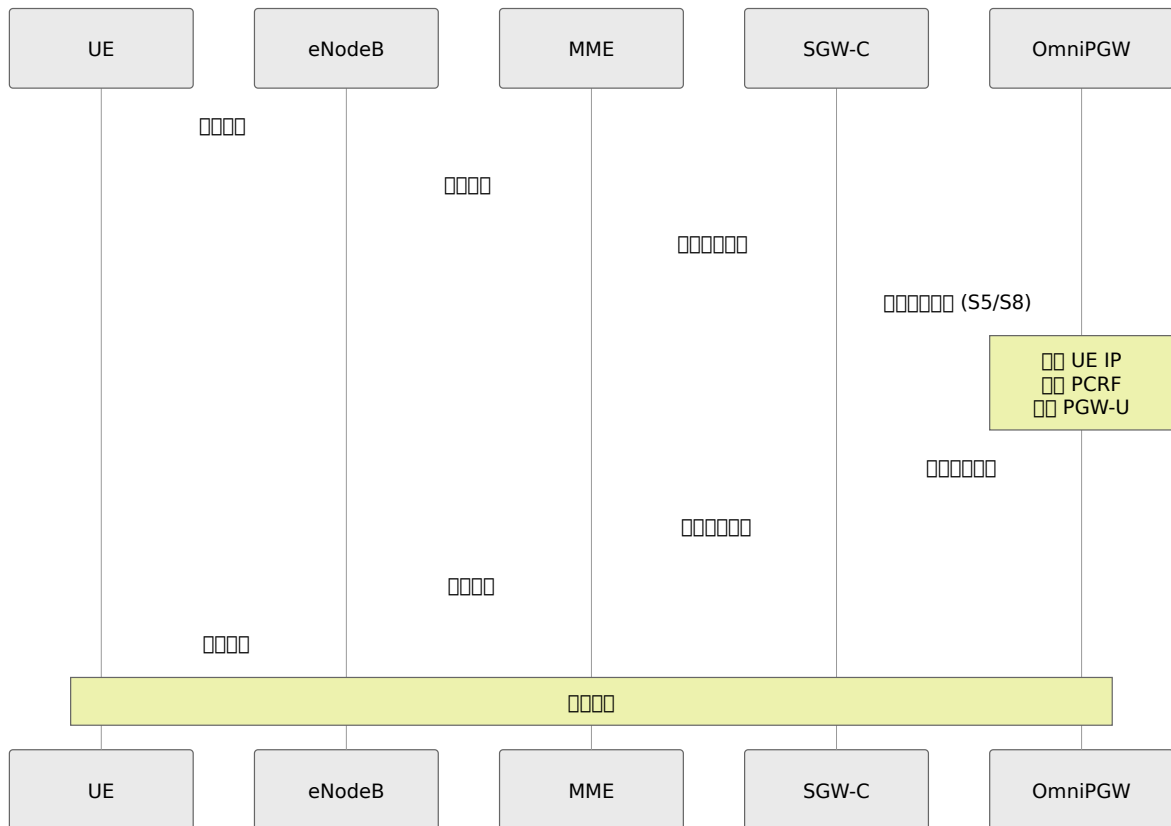

□□□□

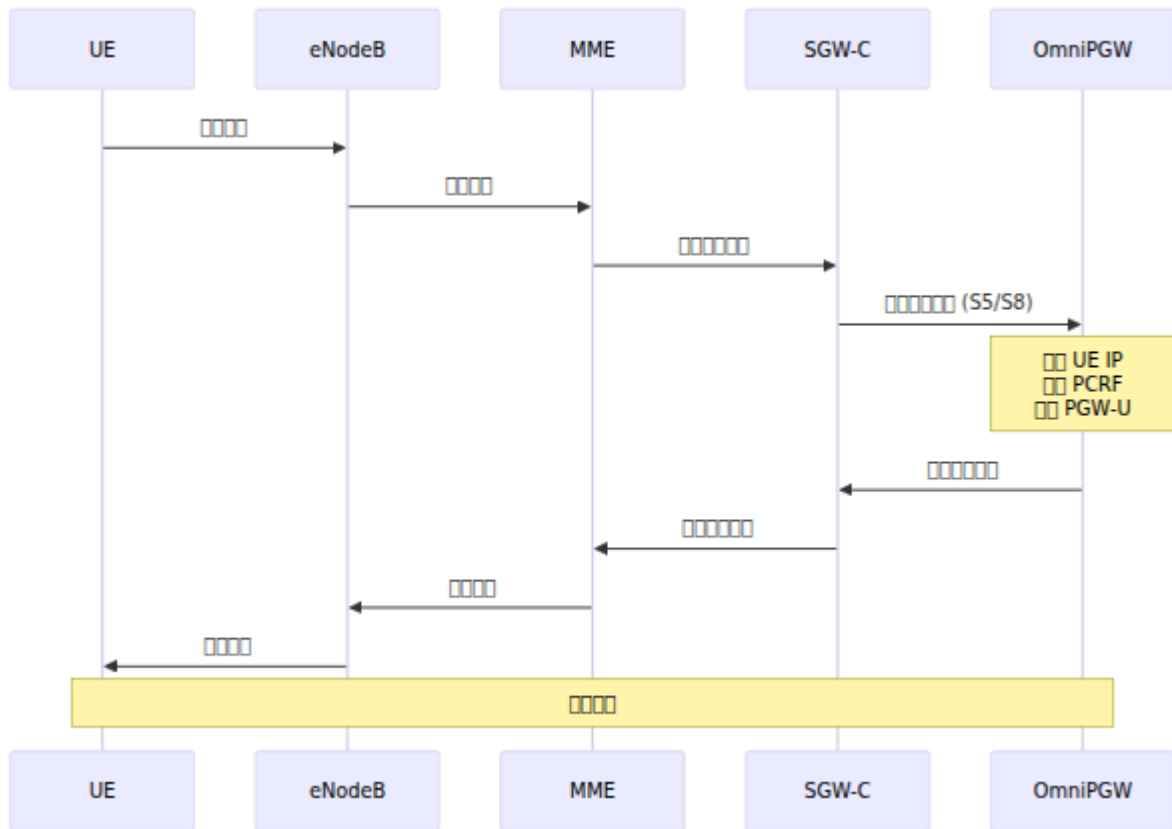

□□□□

□□

|    |        |      |
|----|--------|------|
| □□ | □□     | □□   |
| 16 | □□□□□□ | □□□□ |

□□□□□□□□

| □□ | □□         | □□□□              |
|----|------------|-------------------|
| 65 | □□□□       | PCRF □□□□□□ IMSI□ |
| 66 | □□□□□□     | IP □□□            |
| 93 | □□□□□□□    | □□□ APN           |
| 94 | TFT □□□□□□ | □□□□□□□□          |

□□□□□□□□

| □□ | □□       | □□□□          |
|----|----------|---------------|
| 72 | □□□□□□□□ | PCRF/PGW-U □□ |
| 73 | □□□□□□□□ | □□□□          |

---

□□

## S5/S8 □□

```
□□□□□
s5s8_inbound_messages_total{message_type="create_session_request"}
s5s8_inbound_messages_total{message_type="delete_session_request"}

□□□□□
s5s8_inbound_errors_total

□□□□□□
s5s8_inbound_handling_duration_bucket

□□ TEID
teid_registry_count
```

□□□□□

□□□□□

```
rate(s5s8_inbound_messages_total{message_type="create_session_request"}
[5m])
```

□□□□

```
rate(s5s8_inbound_errors_total[5m])
```

□□□**p95**□□

```
histogram_quantile(0.95,
rate(s5s8_inbound_handling_duration_bucket{request_message_type="create_session_request"}
[5m])
)
```

---

□□□□

## □□□□□□ **OmniPGW** □□□

□□□

- SGW-C □□□□□□□□
- □□□□□□
- SGW-C □□

□□□

1. □□□□□□
2. OmniPGW □□□□□ IP □□□
3. □□□□□ UDP 2123
4. □□□□ TEID □□

□□□

```
□□ OmniPGW □□□□□□
netstat -ulnp | grep 2123

□□□□□□□□
tcpdump -i any -n port 2123

□□□□□
grep "local_ipv4_address" config/runtime.exs

□□□□□□
iptables -L -n | grep 2123
```

□□□□□□□□□□

□□□

- □□□□□□□□□□□□□□
- □□□□□□

□□□□

□□ 65□□□□□□

→ PCRF □□□□

→ □□ HSS/SPR □□ IMSI

□□ 66□□□□□□

→ IP □□□

→ □□□ curl http://pgw:9090/metrics | grep address\_registry\_count

→ □□ IP □

□□ 72□□□□□□□□□□

→ PCRF □□□ PGW-U □□□□

→ □□ Gx □□

→ □□ PFCP □□

## □□□ **TEID** □□

□□□

- □□□□□□□□□□
- □□□□

□□□

- TEID □□□□□□□□
- TEID □□□□□□

□□□□□

- □□□□□ TEID □
  - □□ TEID □□□□□□□□
-

□□□□

□□□□

1. □□□□□□

- □ S5/S8 □□□□□ VLAN
- □□□□□□□□

2. **MTU** □□

- □□ MTU □□ GTP □
- □□ MTU□1500 □□□1464 □□□□ + 36 GTP□

3. □□

- □□ OmniPGW □□
- □ SGW-C □□ DNS □□□□□

□□

1. **UDP** □□□□□

- □□□□□□□□□□□□□□
- □□□□□□□□ 4-8 MB

2. □□□□

- □□□□□□□□□□
- □□ TEID □□□□□□

□□

1. **IP** □□

- □□□□□□□□ SGW-C IP □ GTP-C
- □□ iptables □□□□ ACL

## 2. 概要

- OmniPGW 概要
  - 概要 GTP-C 概要
- 

### 概要

#### 概要

- 概要 - S5/S8 概要 IP 概要
- 概要 - PDN 概要
- **UE IP** 概要 - 概要 IP 概要
- **PCO** 概要 - GTP-C 概要 PCO 概要

#### 概要

- **PFCP** 概要 - S5/S8 概要
- 概要 **Gx** 概要 - 概要
- 概要 **Gy** 概要 - 概要

#### 概要

- 概要 - S5/S8 GTP-C 概要
  - 概要 **CDR** 概要 - GTP-C 概要 CDR
- 

### 概要

---

**OmniPGW S5/S8** 概要 - *OmniTouch* 概要



□□□□

□□□□□

□□□□□□□□□□□□□□□□□□

| □□□                | □□            | □□                   |
|--------------------|---------------|----------------------|
| <b>TEID</b>        | S5/S8 (GTP-C) | SGW-C □□□□□□□ ID     |
| <b>SEID</b>        | Sxb (PCFP)    | PGW-U □□□□□□□ ID     |
| <b>Session-ID</b>  | Gx (Diameter) | PCRF □□□ Diameter □□ |
| <b>Charging-ID</b> | □□            | □□□□□/□□ ID          |

□□□□

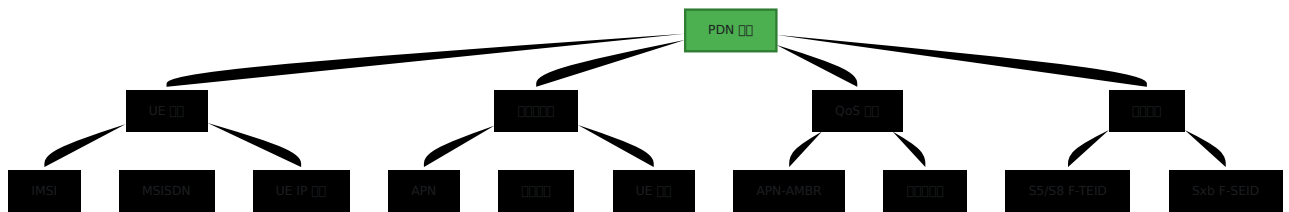

□□□□

□□□□

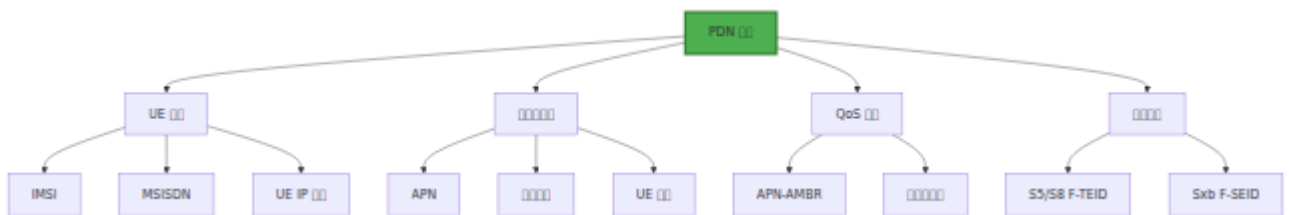

□□

## 1. □□□□□□ (S5/S8)

□□□□□ S5/S8 □□□ GTP-C □□□□□□□□□ GTP-C □□□□□□□□□□ S5/S8 □□□

□□□

- IMSI, MSISDN, IMEI
- APN (□□□“internet”)
- RAT □□ (EUTRAN)
- UE □□ (TAI, ECGI)
- □□□□□ (QoS, F-TEID)

## 2. □□□□

- □ APN □□□□ UE IP
- □□□□ ID
- □□ Gx □□-ID
- □□ S5/S8 TEID
- □□ PGW-U □□□

## 3. □□□□ (Gx)

□ PCRF □□□□□

- □□ CCR-□□
- □□□□ QoS □ PCC □□□ CCA-□□

## 4. □□□□□□ (PFCP)

□□□□□□□□ PGW-U□

- □□□□□□□□
- □□ PDRs, FARs, QERs, BAR
- □□ S5/S8 □□□ F-TEID

## 5. □□ SGW-C

## □□□□□□□□

- UE IP □□
  - S5/S8 F-TEID (□□ PGW-U)
  - PCO (DNS, P-CSCF, MTU)
  - □□□□
- 

## □□□□

## □□□

## □□□□□□□□□□□□

- **QoS** □□ - PCRF □□□□
- □□□□ - □□/□□□□□□
- □□ - SGW □□
- □□□□ - □□ PCRF □□ PCC □□

# QoS

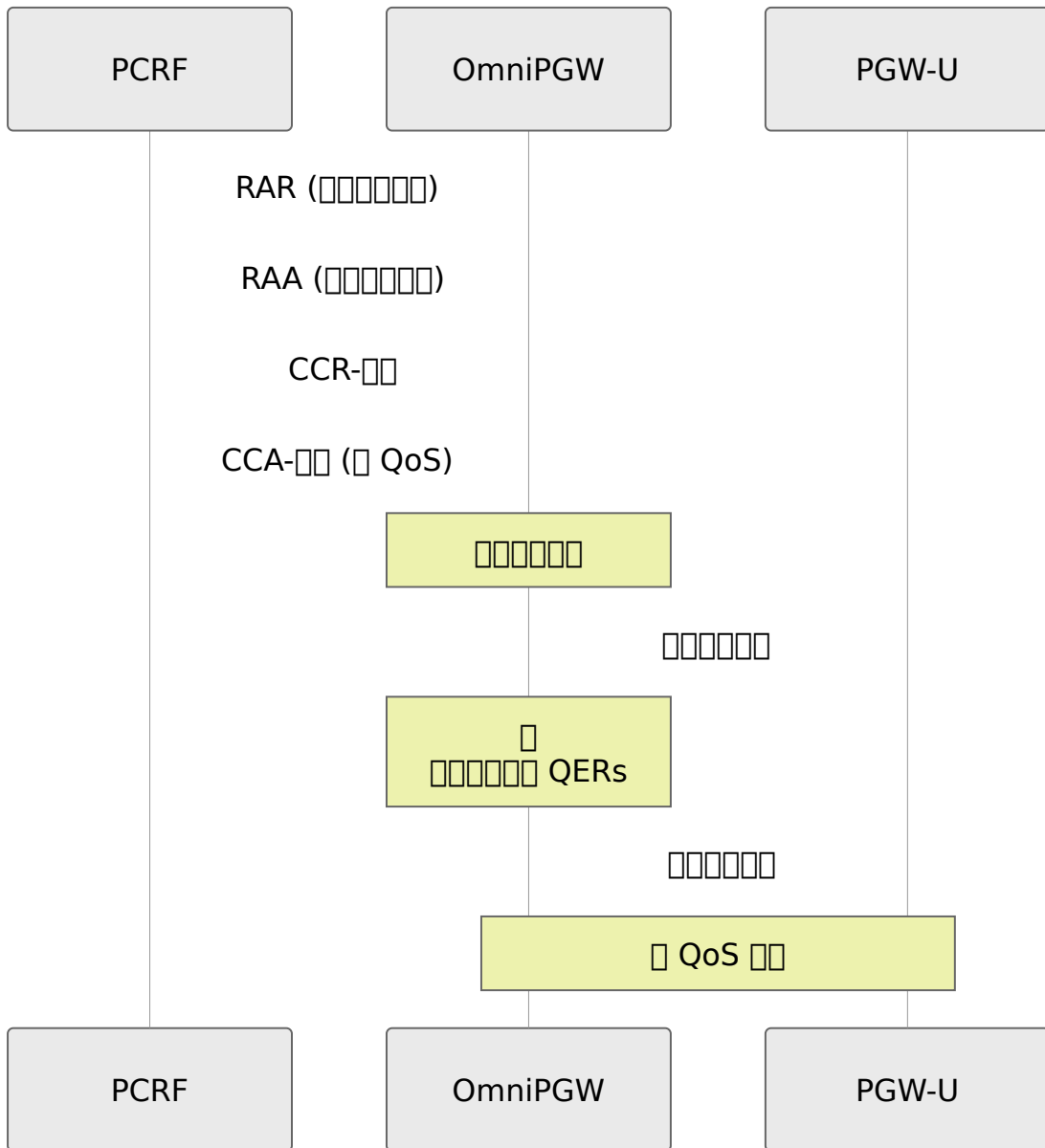

□□□□

□□□□

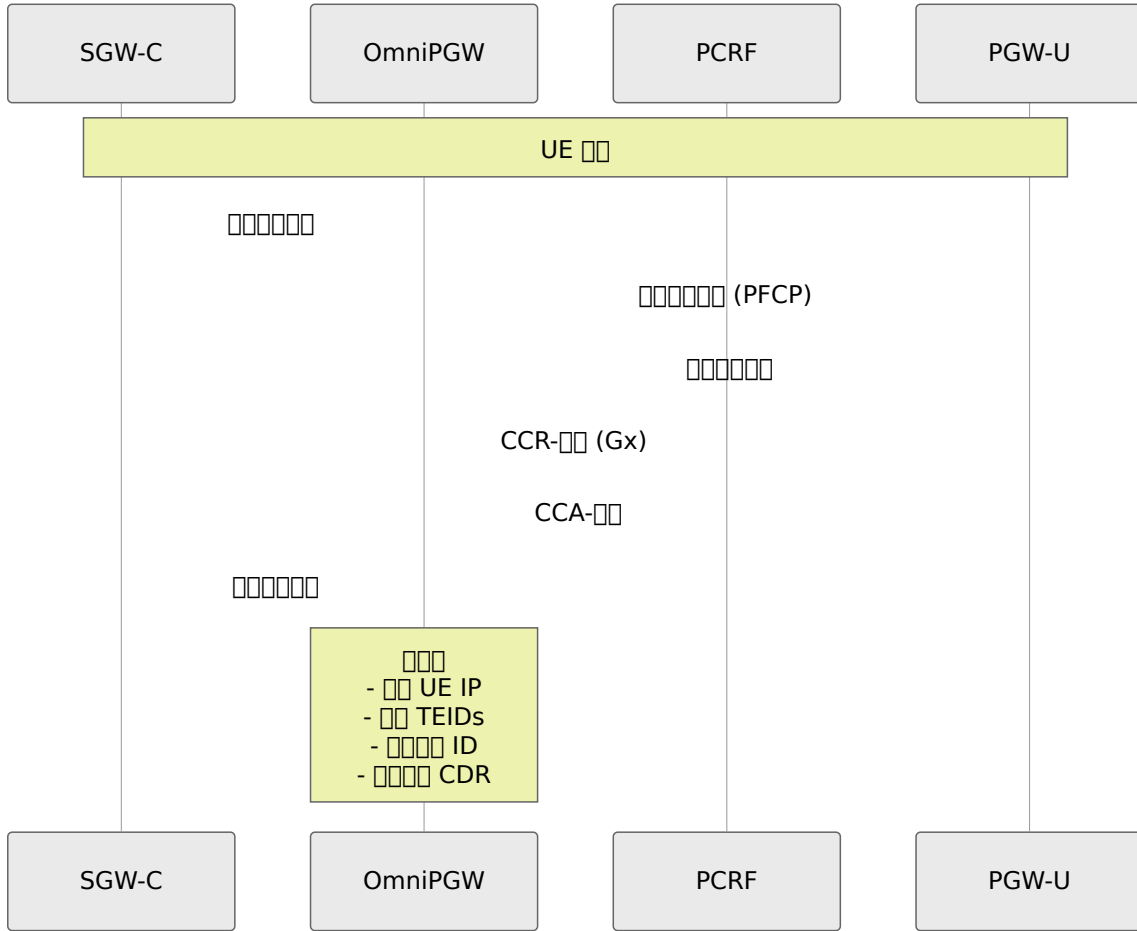

□□□□

□□□□□□

1. UE IP □□ → □□□□
2. TEID → □□□□□□□□
3. SEID → □□□□□□□□
4. □□-ID → □□□□□□□□
5. □□-ID → □□
6. □□□□□□

□□□□□□□□

- 0000000000 CDR (00000000) - 0000 00 CDR 00

0000

0000

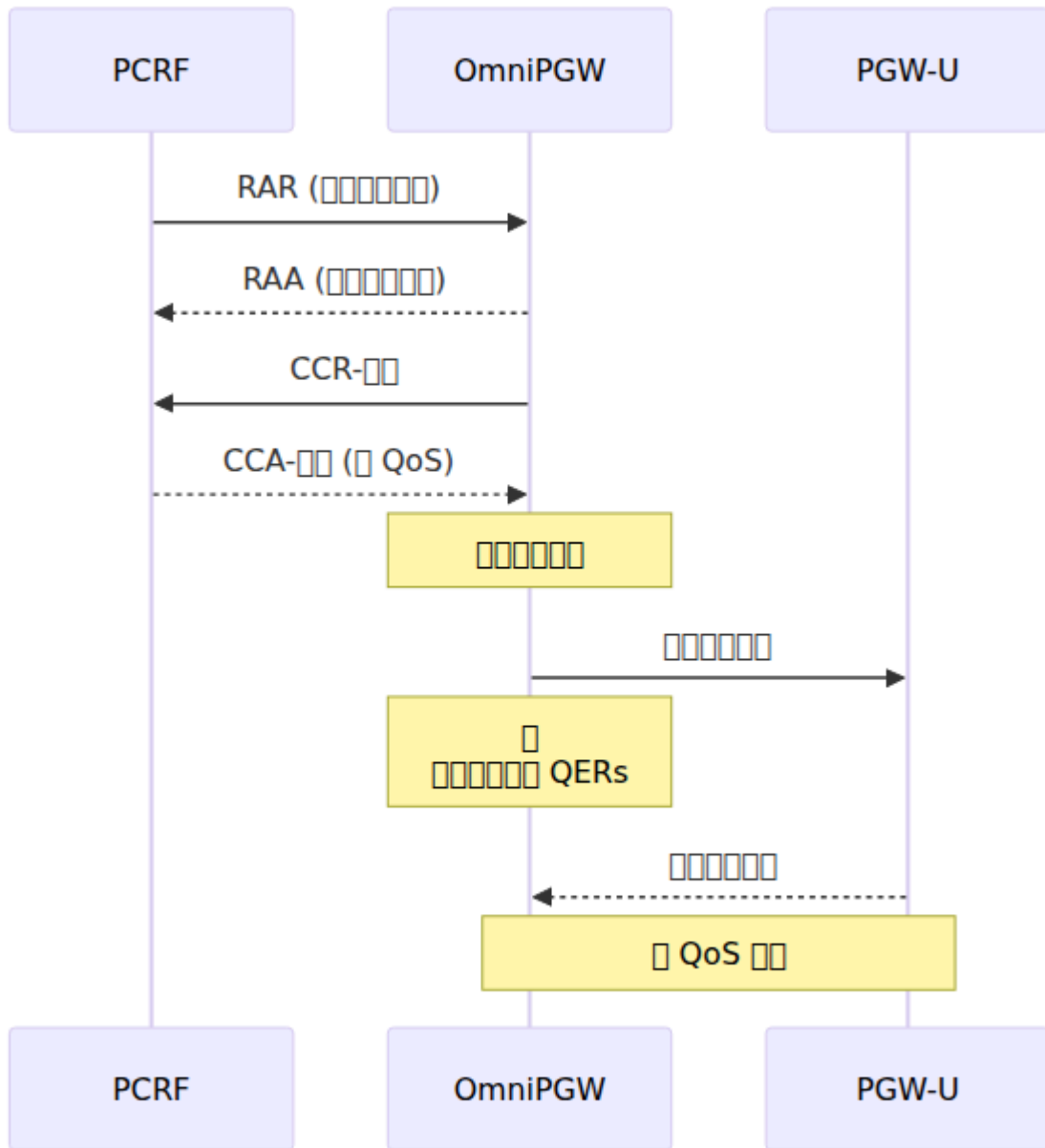

0000

00000000

- TEID (S5/S8):  
TEID 0x12345678 → □□ PID
- SEID (Sxb):  
SEID 0xABCDEF → □□ PID
- □□-ID (Gx):  
"pgw.example.com;123;456" → □□ PID
- UE IP:  
100.64.1.42 → □□ PID
- IMSI + EBI:  
"310260123456789" + EBI 5 → □□ PID

□□□□

□□□□□□

```
□□□□
teid_registry_count

PFCP □□
seid_registry_count

Gx □□
session_id_registry_count
```

□□□□

```
□□□□□□
rate(s5s8_inbound_messages_total{message_type="create_session_request

□□□□□□
rate(s5s8_inbound_messages_total{message_type="delete_session_request

□□□□□□ (p95)
histogram_quantile(0.95,

rate(s5s8_inbound_handling_duration_bucket{request_message_type="crea
[5m])
)
```

□□□□

□□□□□□

□□□

1. **IP** □□□ - □□□□□ IP
2. **PCRF** □□◀◀◀ - Gx □□
3. **PGW-U** □□ - □□ PFCP □□□□□
4. **PCRF** □□ - □□□□□□□□

□□□

```
□□ IP □
curl http://pgw:9090/metrics | grep address_registry_count

□□ PCRF □□□
□□□□□□ Gx □□

□□ PGW-U □□
□□ PFCP □□□□□
```

## □□□□/□□

### □□□

- □□□□□□□
- □□□□□
- □□□□□□□□□□□□

### □□□

1. □□□□□□□□□□
2. □□□□□□□□□□□□
3. □□□□□

### □□□□□

```
□□ OmniPGW (□□□□□□□)
□□□□□□□□□□
```

## UE □□□□□□

### □□□

- UE □□□□
- □□□□□□□□□□□□

### □□□□□□□□

| □□□       | □□                     | □□       |
|-----------|------------------------|----------|
| □□□□□     | PCRF □□ (IMSI □□□□□□□) | □□□□□□□  |
| □□□□□□□   | IP □□□                 | □□ IP □  |
| □□□□□□□□□ | PCRF/PGW-U □□          | □□□□□    |
| □□□□□□    | □□ APN                 | □□ APN □ |

---

□□□□

□□□□

□□□□□□□□

□□□□□□□□10,000

□□□□□□□□~10KB RAM

□□□ RAM~100MB

Erlang VM □□□

- □□□□□□262,144 (□□)

- □□□□□□□□□□□□

□□□□

□□□□□□□□

1. □□□□□□□□□□
2. □□□□□□□□□□□□□□
3. □□□□□□□□□□

□□□□

□□□□□

- □□□□□□□ (□□□□□□□□)
  - □□□□□□□□□□□□□□□ (□□)
  - DNS/□□□□□□□□□□□□
-

□□□□□□

□□□□□□□□□□

□□□□ PDN □□□□□□□□

## UE □□□

- IMSI: "310260123456789" (□□□□)
- MSISDN: "14155551234" (□□□□)
- MEI/IMEI: □□□□□

## PDN □□□□□

- APN: "internet" (□□□□)
- UE IP □□: 100.64.1.42 (□□□ IP)
- PDN □□: IPv4, IPv6 □ IPv4v6

□□□□□□

- □□ ID: □□□□□□□□
- □□□□ EBI: EPS □□□□□ (□□□ 5)

## QoS □□□

- APN-AMBR: □□□□□□□□
  - □□□100 Mbps
  - □□□50 Mbps

□□□□□

- PDRs (□□□□□□□□): □□□□□
- FARs (□□□□□□□□): □□/□□□□□
- QERs (QoS □□□□□): □□□□□
- BAR (□□□□□□□□): □□□□□

□□□□□□

- S5/S8 : / TEIDs, SGW-C
  - Sxb : / SEIDs, PGW-U
  - Gx : Diameter -ID,
- 

## Web UI -

OmniPGW  **Web UI**

### UE

:

:  UE

#### 1.

- **IMSI** (“310170123456789”)
- **MSISDN** ()

- **IP** 地址 (例如“100.64.1.42”)

## 2. 网络

- 网络地址
- 网络掩码
- 网络接口

## 3. 网络配置

### a) 网络

- 网络名称
- IMSI, MSISDN, UE IP 地址
- APN, RAT 类型
- PGW TEID, SGW TEID

### b) 网络标识

- **TAC** (跟踪区代码) - UE 跟踪区代码
- **小区 ID (ECI)** - E-UTRAN 小区 ID
- **ECGI** - E-UTRAN 全球唯一标识符 (PLMN + ECI)
- **MCC/MNC** - 移动国家代码 / 移动网络代码

网络标识 OpenCellID 网络标识

- 网络名称 (网络/网络)
- 网络 Google 网络标识
- UE 网络标识

网络标识 网络标识 网络标识

### c) 网络配置 QoS 网络

网络:

- EBI (EPS 网络标识)
- QCI (QoS 网络标识)
- 网络标识

- APN-AMBR (□□/□□)

□□□□ (□□□□)□

- EBI, QCI, □□□□□□
- MBR UL/DL (□□□□□)
- GBR UL/DL (□□□□□)

**d)** □□□□ (Gy □□)

- Gy □□ ID
- □□□□, □□□□
- □□□□

**e)** □□□□ (Gx □□)

- Gx □□ ID
- PCRF □/□□□□
- CC □□□□
- □□□□□□□□ (□□□□□ PCC □□)

**f)** □□□□

- □□□□□□□□
- □□□□/□□/□□□□

□□□

- □□□□□□□□
- □□□□□□
- □□□□□ IP □□
- □□□□□□

## **PGW** □□□□

□□: `http://<omnipgw-ip>:<web-port>/pgw_sessions`

UE: 3GPP PDN UE

UE

### 1. UE

- IMSI (UE ID)
- UE IP
- APN - UE

### 2. UE 3GPP UE

- **IMSI** - UE
- **UE IP** - UE IP
- **SGW TEID** - UE SGW S5/S8 ID
- **PGW TEID** - UE OmniPGW S5/S8 ID
- **APN** - UE

### 3. UE 3GPP UE

- IMSI (UE "310260")
- UE IP (UE "100.64")
- MSISDN / UE



00: 0000000000000000

000

### 1. 00000

- 0000000000
- 00 PGW-C (0000) 00
- 000 HSS (00000000) 000
- 0000000000

### 2. 0000

- 0000 (+/-)
- 00000000
- 000000000000
- 0000000 (00 = 00, 00 = 00)

### 3. 0000

- 000000000000
- 0000
- 0000000000

□□□

- □□□□□□□□□□□□
- □□□□□□
- □□□□□□
- □□□□□□□□

□□□□□□□□□□

□□: `http://<omnipgw-ip>:<web-port>/session_history`

□□: □□□□□□□□□□□□

□□□

### 1. □□□□

- □□□□□□□ (□□□□, □□□□, □□□□, □)
- □□□□□□ (□□□□ / □□□□)
- □ IMSI, MSISDN, IP □□□□ TEID □□

### 2. □□□□

- CSV
- 
- 

### 3.

- 
- 
- 
- 

#### 

- 
- 
- 
- 
- 

#### 

#### 

- 1.
2. IMSI Web UI
3. UE IP
4. QoS
- 5.

#### 

- 
- 
- APN

####

- 認證
- 認證 SSH/IEEx
- SGW PGW TEIDs 認證
- PCRF AMBR

## 認證

- 認證 (認證)
- 認證
- 認證 (Mbps 認證 bps)
- 認證
- 認證

## 認證

OmniPGW 認證 OpenCellID 認證 UE 認證

## 認證

認證 UE 認證

- 認證 (認證)
- 認證 Google 認證
- 認證
- 認證

## 認證

認證 `http://<omnipgw-ip>:<web-port>/cell_towers` 認證 “認證” 認證

## 認證

- OpenCellID.org 認證

- 使用 SQLite
- 数据量 (约 10-15 万)
- 使用 Web 界面
- 支持多种查询方式

数据库 使用 SQLite 数据库 “**???**” 支持多种查询方式

## 数据库

### 数据库

- SQLite DB: `priv/cell_towers.db`
- CSV 文件 (约): `priv/data/cell_towers.csv.gz`
- 支持 MCC, MNC, LAC, CellID 等多种查询

### 数据库

- 从 OpenCellID.org 下载数据 107 MB
- 支持多种查询方式 10-15 万

### 数据库

- 支持多种查询方式 (<1ms)
- 支持多种查询方式
- 支持 UE 等多种查询

## 数据库

### 数据库

### UE 数据库

- 支持多种查询方式
- 支持 Google 等多种查询
- 支持多种查询方式

### Web UI



- 3GPP TS 22.061
- OpenCellID 数据库 - 全球蜂窝网络数据库
- 提供 Web UI 访问数据库

### 网络层

- 使用 `priv/` 数据库
- 数据库大小 (~150 MB)
- 数据库使用 `priv/` 数据库/数据库

### 应用层

- 网络层
- OpenCellID 数据库
- 数据库

### 应用层

- 使用 JavaScript 数据库
- 使用 Google 数据库
- 数据库



### 网络层

- **PFCP** 消息 - 会话管理, PDRs, FARs, QERs, URRs
- **UE IP** 消息 - IP 地址, APN 消息
- **PCO** 消息 - 通知 UE 的 DNS, P-CSCF, MTU 消息
- **消息** - UPF 消息, 数据库

### 应用层

- **Diameter Gx** 消息 - PCRF 消息, PCC 消息, QoS 消息
- **Diameter Gy** 消息 - OCS 消息, 数据库

- **CDR** -

- **S5/S8** - GTP-C, SGW-C
- **QoS** - QoS

- - , ,
- **P-CSCF** - IMS

---

---

**OmniPGW** - *OmniTouch*

# OmniPGW

OmniPGW

OmniPGW

## OmniPGW

- OmniPGW
- OmniPGW
- OmniPGW
- PFCP / OmniPGW
- Diameter (Gx/Gy) OmniPGW
- IP OmniPGW
- OmniPGW
- OmniPGW
- OmniPGW

## OmniPGW

OmniPGW

- OmniPGW
- OmniPGW
- OmniPGW
- OmniPGW
- OmniPGW

## OmniPGW

- OmniPGW - Prometheus

- `omnipgw` - `omnipgw`
- 

`omnipgw`

## Web UI

`http://<omnipgw_ip>:4000`

`omnipgw`

- `/pgw_sessions` - IMSI, IP, MSISDN, APN
- `/diameter` - Diameter Gx, PCRF, Gy, OCS
- `/pfcpeers` - PFCP PGW-U
- `/logs` - logs

## Prometheus

`http://<omnipgw_ip>:9090/metrics`

`omnipgw`

- `teid_registry_count` - teid
- `address_registry_count` - UE IP
- `sxb_inbound_errors_total` - PFCP
- `gx_inbound_errors_total` - Diameter Gx
- `gy_inbound_errors_total` - Diameter Gy

`omnipgw` `omnipgw`

`omnipgw`

Web UI `/logs`

`omnipgw`

- "create\_session\_request" - 0000
  - "Credit Control" - Gx/Gy 00
  - "PFCP Session" - 000000
  - "error" 0 "ERROR" - 0000
  - "timeout" - 0000
- 

00000000

00000000000000000000 "000000"

000

- SGW-C 000000000000 "000000" (73)
- 000000000000
- 0000000000
- 000 [PGW-C] 0000000000 - 000000

Wireshark 0000000000000000 "000000"

00000

- 000000 OmniPGW 000

- 000000000000

0000

1. 0000000000

```
license_status
```

- 00 0 00000000

2. 00000000000000

- 00 "license" 0 "License"
- 00 "000000000000" 00

3. 00000000000000

- 00 config/runtime.exs 0 :license\_client 0000 URL
- 0000 https://localhost:10443/api

000000

1. 0000000000000000

```
curl -k https://<license_server_ip>:10443/api/status
```

2. 00 config/runtime.exs 0000000000

```
config :license_client,
 license_server_api_urls:
 ["https://<license_server_ip>:10443/api"],
 licensee: "00000000"
```

3. 0000000000000000

- 000000 omnipgwc
- 00 Omnitouch 00000000



### 3. PFCP

- Web UI → /pfcp\_peers
- "Association: DOWN"
- pfcp\_peer\_associated = 0

### 4. APN

- config/runtime.exs ue.apn\_map
- APN

### IP

1. Web UI → /pgw\_sessions
2. config/runtime.exs IP

```
config :pgw_c,
 ue: %{
 subnet_map: %{
 "internet" => "10.0.0.0/23" # /24 /23
 }
 }
```

### 3. OmniPGW

4. curl http://<ip>:9090/metrics | grep address\_registry\_count

### PCRF

1. ping <pcrf\_ip>
2. PCRF Diameter telnet <pcrf\_ip> 3868
3. config/runtime.exs Diameter
4. OmniPGW
5. Web UI → /diameter "connected"

### PCFP

- PFCP /

□□□

- □□ IP □□□□□□□□ 80% □□□
  - □□ PCRF □□□□□□ Diameter □□□□
  - □□□□□□□□□□
- 

□□□□□□□□□□□□□□

□□□

- □□□ Web UI □□□□□□□□
- □□□□□□□□□□□□□□□□□□
- □□□□□□□□□□□□

□□□□□

1. PFCP □□□□□□□□ S5/S8 □□□□□□
2. PCRF CCR-Initial □□
3. □□□□□□□□□□□□□□□□
4. □□□□□□□□□□□□

□□□

1. □ **Web UI** □□□□□□□□
  - `/pgw_sessions` → □ IMSI □□
  - □□ `pfcp_seid` □□□□□□□□□□□□ PFCP □□□
  - □□ `gx_session_id` □□□□□□□□□□□□ Gx □□□
2. □□□□□□ **IMSI**□
  - □ IMSI □□□□□
  - □□ "Session Establishment Request"□PFCP□
  - □□ "Credit Control Request"□Gx□
  - □□□□□□□□□□
3. □□□□□

```
TEID PFCP
teid_registry_count - seid_registry_count

TEID Gx
teid_registry_count - session_id_registry_count
```

□□□□

### 1. PFCP □□□□

- PGW-U □□□□□□
- PFCP □□□□ Web UI → **/pfcpeers**
- SGW-C □□□□□□□□□□

### 2. Gx □□□□

- PCRF □□□ `histogram_quantile(0.95, rate(gx_outbound_transaction_duration_bucket[5m]))`
- □□□□□□ `config/runtime.exs` □□□ Gx □□
- □□□□□□□□□□

### 3. □□□□□□□□□□

- □□□□□□ OmniPGW □□□□□□□□
- □□□□□□□□ `teid_registry_count` □□□□□

□□□

- PFCP □ Gx □□□□
  - □□□□□□□□□□□□□□□□□□
  - □□□□□□□□□□□□
-

# PFCP / 配置

## PFCP 配置

配置

- Web UI → `/pfcpeer` 显示 "Association: DOWN"
- 配置检查
- 检查 `pfcpeer_associated` = 0
- 检查 "PFCP 配置" 是否正确

配置

1. PGW-U 配置
2. PGW-U 配置
3. PFCP 配置 IP
4. 配置 UDP 8805

配置

1. 配置

```
ping <pgw_u_ip>
nc -u -v <pgw_u_ip> 8805
```

2. 检查 PFCP 配置

- 检查 `config/runtime.exs` 中的 `upf.peer_list`
- 检查 IP 地址 ID 是否正确 PGW-U 配置

3. 检查 PGW-U 配置

- 检查 PGW-U 配置
- 检查 PGW-U 配置 `systemctl status omnipgw_u`

4. 配置

```
0000
pfcf_consecutive_heartbeat_failures

PFCP 000
rate(sxb_inbound_errors_total[5m])
```

00000

### 1. 00000000

- 000000 `traceroute <pgw_u_ip>`
- 000000000000 UDP 8805 000
- 000000000000000

### 2. 00 **PGW-U** 000

- 00 PGW-U 00
- 00 30 0000000000
- 00 Web UI → **/pfcf\_peers** 000000 "Association: UP"0

### 3. 00000000

- 00 `config/runtime.exs` 00 PFCP 0000
- 00 OmniPGW
- 0000000000

000

- 00 `pfcf_peer_associated` 000000000000
- 00 `pfcf_consecutive_heartbeat_failures` 000000 > 20
- 0000 PGW-U 00
- 00 PFCP 0000/000000000000

## 000**PFCP** 00000000

000

- 00000000
- QoS 00000000 PCRF RAR000
- 000"00000000"
- 000

```
sxb_inbound_errors_total{message_type="session_modification_respon
se"} 00
```

00000

1. 000 PFCP 000PDR/FAR/QER 000
2. PGW-U 0000
3. 00 ID 00
4. PGW-U 0000

000

1. 00000
  - 00 "0000" 0 SEID
  - 00 PFCP 0000000000
  - 00000"00 ID 000"0"0000"

## 2. 00 **PGW-U** 000

- 00 PFCP 0000
- 00000000CPU0000

## 3. 0 **Web UI** 00000000

- **/pgw\_sessions** → 0 IMSI 0000
- 00 pdr\_map 0 far\_map 0 qer\_map 000000
- 0000 ID

00000

## 1. 00000000

- 000000000000
- 00000000000000 UE 0000

## 2. PGW-U

- PGW-U PDR
- PGW-U
- PGW-U

## 3.

- Web UI
- PFCP
- 

- PGW-U
- 
- `sxb_inbound_errors_total`

---

# Diameter (Gx/Gy)

## PCRF Gx

- Web UI → **diameter** PCRF "disconnected"
- QoS QCI=5
- "Diameter" "CER/CEA"

- PCRF
- PCRF
- Diameter Origin-Host Realm
- TCP 3868

## 1. ping

```
ping <pcrf_ip>
telnet <pcrf_ip> 3868
```

## 2. Diameter

- `config/runtime.exs` `diameter.peer_list`
- `host` `realm` `ip` PCRF
- `origin_host` PCRF

## 3. PCRF

- PGW-C CER
- 

## 4. Diameter

```
Diameter
diameter_peer_connected{peer="<pcrf_host>"}
```

## 1. ping

- PCRF
- TCP 3868
- `nc -v <pcrf_ip> 3868`

## 2. PCRF

- PCRF
- 30
- Web UI → **diameter**

## 3. Diameter

- `config/runtime.exs` Diameter

```

config :pgw_c,
 diameter: %{
 host: "pgw-c.epc.mnc999.mcc999.3gppnetwork.org", # []
 PCRF []
 realm: "epc.mnc999.mcc999.3gppnetwork.org",
 peer_list: [
 %{
 host: "pcrf.epc.mnc999.mcc999.3gppnetwork.org",
 realm: "epc.mnc999.mcc999.3gppnetwork.org",
 ip: "192.168.1.100",
 initiate_connection: true
 }
]
 }
}

```

- [] OmniPGW
- []

[][]

- [] Diameter []
- [] PCRF []
- [] Diameter []

## [][] CCR/CCA [] Gx []

[][]

- [] > 5 []
- [] "[]"
- [] gx\_outbound\_transaction\_duration [] > 5s
- [] QoS []

[][]

1. PCRF []
2. PCRF []
3. []

#### 4. PCRF 配置

配置

##### 1. 配置 Gx 配置

```
P95 配置
histogram_quantile(0.95,
rate(gx_outbound_transaction_duration_bucket[5m]))

P99 配置
histogram_quantile(0.99,
rate(gx_outbound_transaction_duration_bucket[5m]))
```

##### 2. 配置 PCRF 配置

- 配置 PCRF 配置
- 配置 CPU 配置
- 配置 PCRF 配置

##### 3. 配置配置

```
ping -c 100 <pcrf_ip> | tail -1 # 配置配置
```

##### 4. 配置配置

- 配置 CCR/CCA 配置 "配置"
- 配置 "配置 CCR" 与 "配置 CCA" 配置

配置配置

##### 1. 配置 PCRF 配置

- 配置 PCRF 配置
- 配置 CCR 配置
- 配置 PCRF 配置/配置

##### 2. 配置配置

- 設定ファイルを確認
- 設定 PGW-C の PCRF 設定を確認

### 3. 設定を確認

- 設定 `config/runtime.exs`

```
config :pgw_c,
 diameter: %{
 transaction_timeout_ms: 10000 # 設定 5000 秒
 }
```

- 設定 OmniPGW
- 設定 設定ファイルを確認

設定

- 設定 Gx 設定ファイル > 1s > 5s
- 設定ファイル PCRF 設定
- 設定 PCRF 設定

## 設定 OCS 設定 Gy

設定

- Web UI → **/diameter** 設定 OCS 設定 "disconnected"
- 設定ファイル
- 設定 "Gy 設定"

設定

設定 PCRF 設定 Gy 設定

設定

- 設定 TCP 3868 設定 Gx 設定
- 設定ファイル
- 設定 `diameter.peer_list` 設定 OCS 設定



```
teid_registry_count
teid_registry_count
address_registry_count
```

#### 4. `teid_registry_count`

- Web UI → `/pgw_sessions`
- `teid_registry_count`
- `address_registry_count`

`teid_registry_count`

`address_registry_count`

#### 1. `config/runtime.exs`

```
config :pgw_c,
 ue: %{
 subnet_map: %{
 "internet" => "10.0.0.0/22" # 1022 IP /24 = 254 IP
 }
 }
}
```

#### 2. `OmniPGW`

#### 3. `teid_registry_count`

`teid_registry_count`

1. `Web UI` `teid_registry_count`
2. `SGW-C` `teid_registry_count`
3. `PCRF/SGW` `teid_registry_count`
4. `address_registry_count` `teid_registry_count`

`teid_registry_count`

- `IP` `teid_registry_count`
  - `teid_registry_count` > 70%
  - `teid_registry_count` > 85%

- `IPsec`
- `IPsec`
- `IPsec`

## IPsec

UE

- UE IPsec
- `"IPsec"`
- Web UI `IPsec`

IPsec

1. `IPsec`
2. `IPsec`
3. `IPsec`

IPsec

1. **Web UI IPsec**
  - `/pgw_sessions` → IPsec
  - IMSI IPsec
2. `IPsec`
  - IPsec
  - `"IPsec"`

IPsec

1. `IPsec`
  - IPsec IMSI
2. `IPsec`
  - SGW-C IMSI

- □□□□□□□□

### 3. UE □□□□

- UE □□□□□□
- □□□□□□ IP

### 4. □□□□□□

- □□ OmniPGW □□□ IP □□
- □□□□□□□□□□□□□□

□□□

- □□□□□□□□□□□□□□
  - □□□□□□□□□□□□□□
-

□□□□

## □□ Prometheus □□

```
□□□□
teid_registry_count

□□□□□□□□□□
rate(s5s8_inbound_messages_total{message_type="create_session_request"

IP □□□□□□□□ /24 □□□
(address_registry_count / 254) * 100

P95 □□□□□□□
histogram_quantile(0.95,
rate(s5s8_inbound_handling_duration_bucket{request_message_type="crea
[5m]))

□□□
rate(s5s8_inbound_errors_total[5m])

PCRF □□
histogram_quantile(0.95, rate(gx_outbound_transaction_duration_bucket

PFCP □□□□
pfcf_peer_associated
```

# Web UI

| 項目               | 値          |
|------------------|------------|
| IMSI             | XXXXXXXXXX |
| "create_session" | XXXXXXXX   |
| "delete_session" | XXXXXXXX   |
| "Credit Control" | Gx PCRF 項目 |
| "PFCP Session"   | XXXXXXXX   |
| "error"          | XXXXXXXX   |
| "timeout"        | XXXX       |
| "Association"    | PFCP 項目    |

## 📄📄📄📄

```
📄📄📄📄
systemctl status omnipgw_c

📄📄 Web UI
curl http://<omnipgw_ip>:4000

📄📄📄📄
curl http://<omnipgw_ip>:9090/metrics

📄📄📄📄
curl http://<omnipgw_ip>:9090/metrics | grep teid_registry_count

📄📄 PFCP 📄📄
curl http://<omnipgw_ip>:9090/metrics | grep pfcpeer_associated

📄📄 IP 📄📄📄📄
curl http://<omnipgw_ip>:9090/metrics | grep
address_registry_count
```

## 📄📄📄📄

- 📄📄📄📄 - Prometheus 📄📄 Grafana 📄📄📄📄
- 📄📄📄📄 - 📄📄📄📄📄
- 📄📄📄📄 - 📄📄📄📄📄📄📄📄
- **PFCP 📄📄** - PFCP 📄📄📄📄📄📄
- **Diameter Gx 📄📄** - Gx 📄📄📄📄📄
- **Diameter Gy 📄📄** - Gy 📄📄📄📄📄
- **QoS 📄📄📄📄** - QoS 📄📄📄

## 📄📄📄📄

**OmniPGW 📄📄📄📄** - 📄 *Omni*touch 📄📄📄📄📄

# UE IP



IP

---



- 1.
  2. IP
  - 3.
  - 4.
  - 5.
  - 6.
  - 7.
- 



PGW-C UE PDN IP

## UE IP 할당

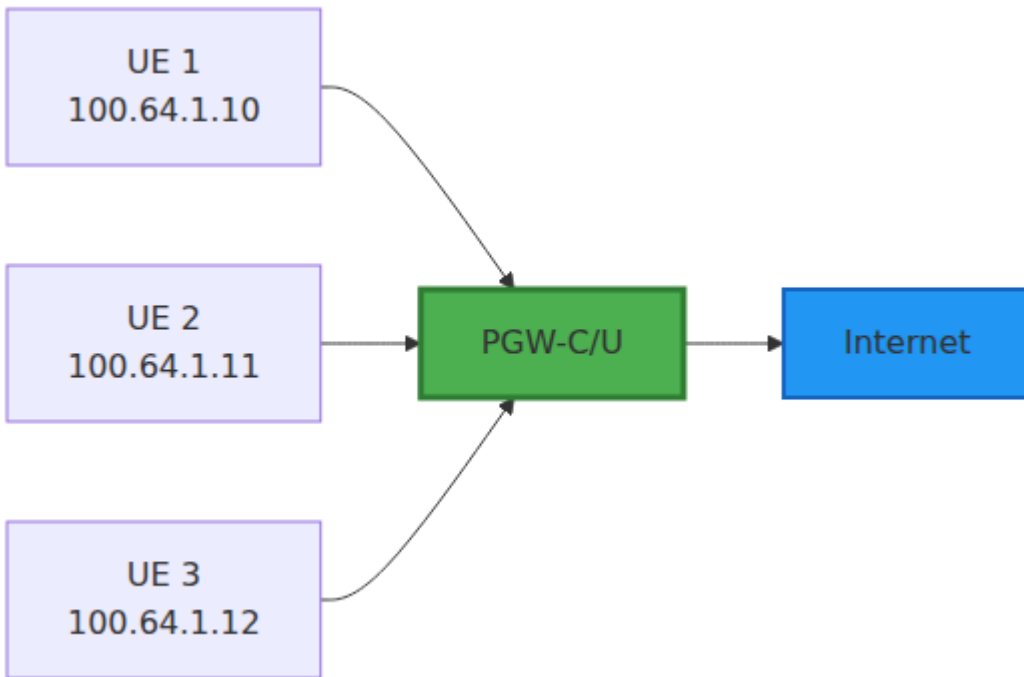

UE가 PGW-C에 접속할 때 IP 할당

- IP 할당
- IP 할당
- IP 할당
- PDN 할당

## UE IP 할당

| IP 할당         | 할당 | 할당              |
|---------------|----|-----------------|
| <b>IPv4</b>   | 할당 | 할당 IPv4 할당      |
| <b>IPv6</b>   | 할당 | IPv6 할당         |
| <b>IPv4v6</b> | 할당 | 할당 IPv4 할당 IPv6 |

# IP 地址

## PDN 类型

UE 的 PDN 类型由 PDN 类型决定

| PDN 类型 | 地址      | 地址范围            |
|--------|---------|-----------------|
| IPv4   | IPv4 地址 | IPv4 地址         |
| IPv6   | IPv6 地址 | IPv6 地址/64      |
| IPv4v6 | 地址      | IPv4 地址 IPv6 地址 |

地址

PGW-C 地址 IP 地址

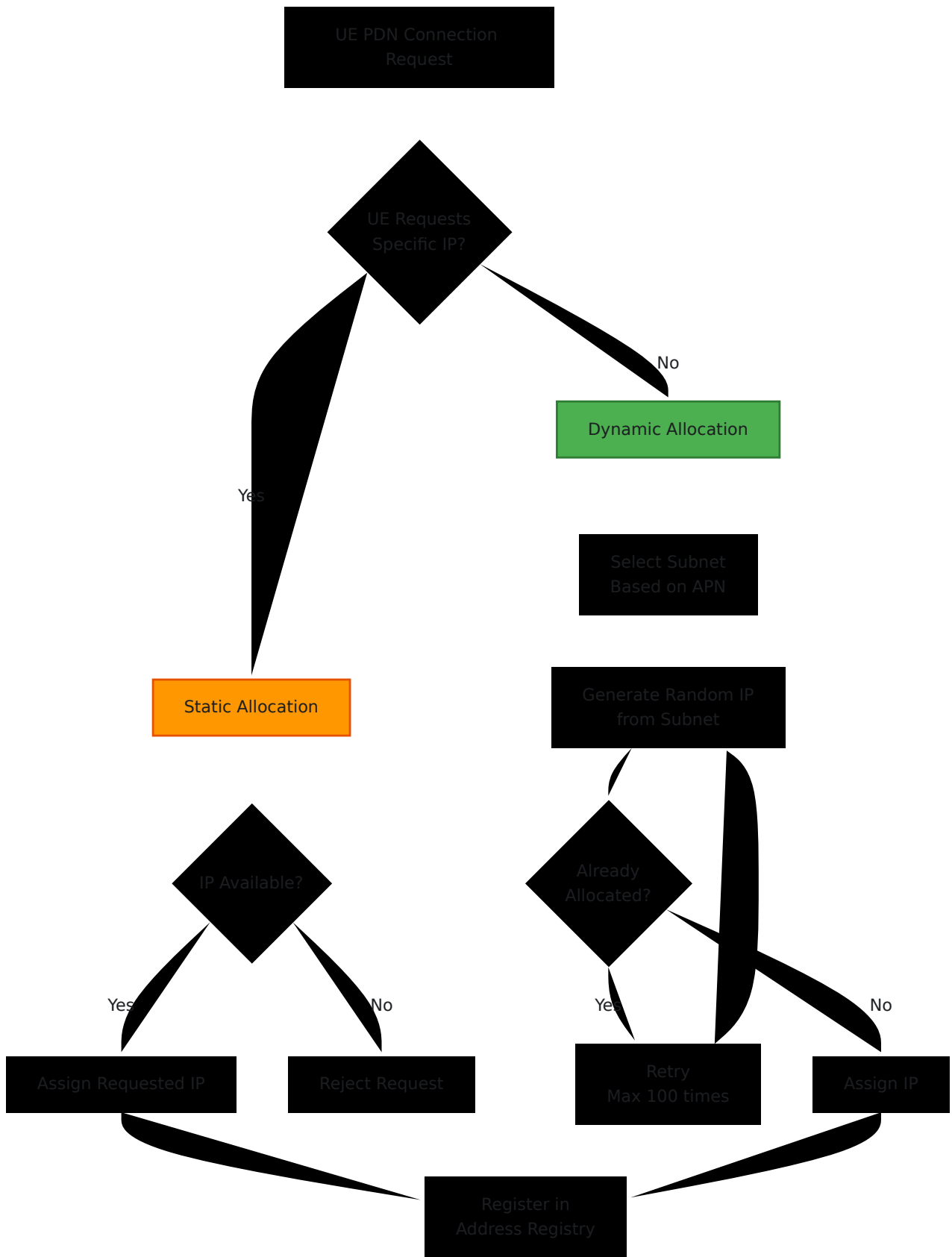

1. IP 할당 프로세스

- PGW-C IP 할당 프로세스
- IP 할당 프로세스

- □□□□□□□□

## 2. □□□□

- UE □ GTP-C □□□□□□ IP
- PGW-C □□□□
- □□□□□□ IP □□□□

## □□ **APN** □□□□

□□ **APN**□□□□□□ □□□□□□ IP □□

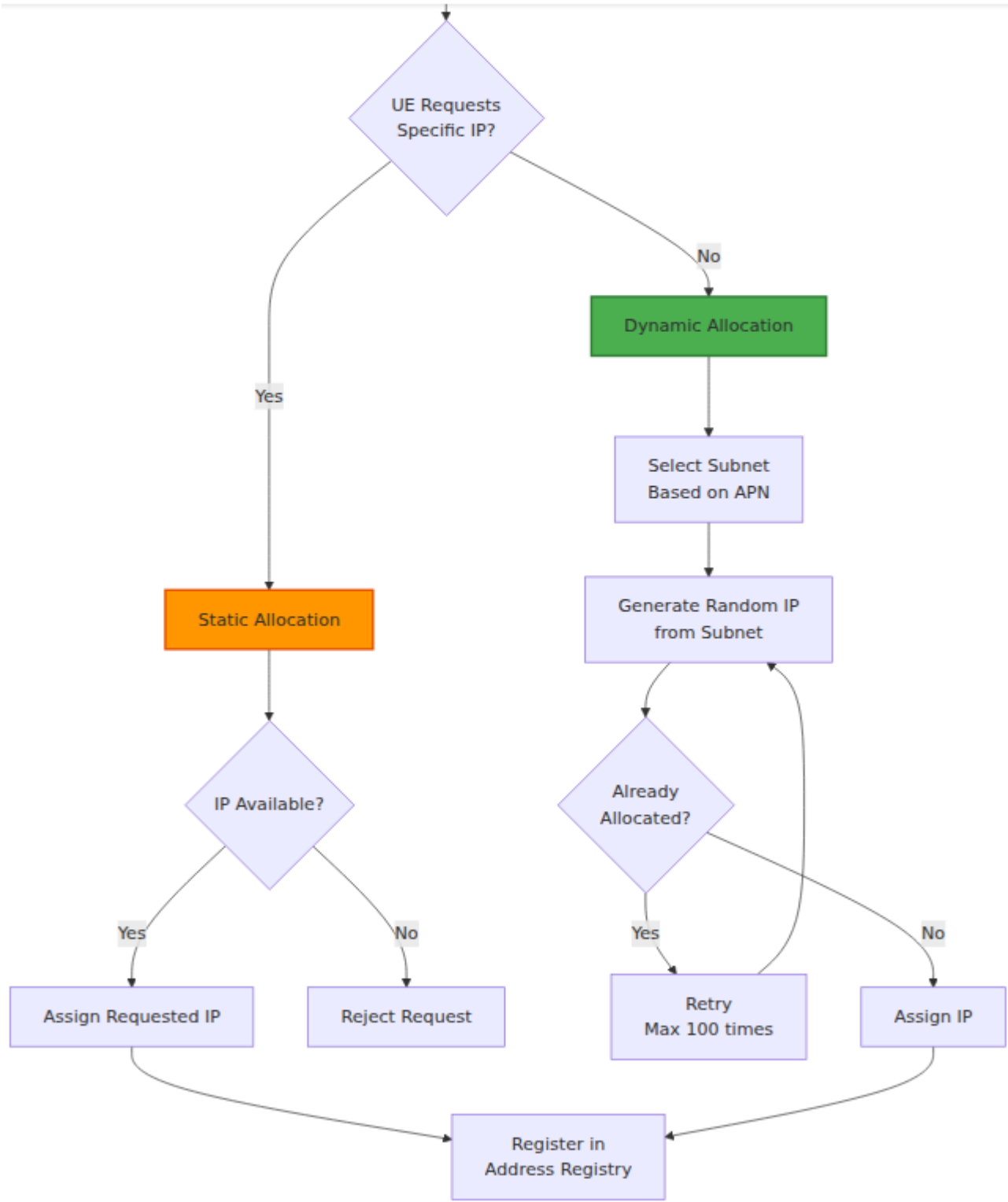

□□□

- □□□□ - □□ APN □□□□□□□□
- □□❓❓□□ - □□□□ APN □□□□□□□□

- 0000 - 0000000000000000
- 00 - 000000000000

0000

0000 000000 IP

| 00   | 00                  |
|------|---------------------|
| 00   | 00 UE IP → 0000 PID |
| 00   | 00 UE IP 0000       |
| 00   | 00000000 IP         |
| 0000 | 000000              |

00

0000

00 `config/runtime.exe`



```

config :pgw_c,
 ue: %{
 subnet_map: %{
 # IMS APN
 ["ims"|"ims.apn"|"ims.something.else"]
 "^ims" => [
 "100.64.10.0/24"
],

 # M2M APNs
 ["m2m."|"m2m.test"|"m2m.prod"]
 "^m2m\." => [
 "100.64.20.0/24"
],

 # Enterprise - "enterprise.corp"
 "enterprise.corp" => [
 "10.100.0.0/16"
],

 # Default APN
 default: [
 "42.42.42.0/24"
]
 }
 }
}

```

## References

- [Elixir/Erlang](#)
- [Elixir](#)
- [^](#)
- 
- 

## References

| Pattern      | Regex               | Matches                     |
|--------------|---------------------|-----------------------------|
| ims...       | "^ims"              | ims, ims.apn, ims.anything  |
| ...corp      | "^.*\\.corp\$"      | foo.corp, bar.corp          |
| test         | "^.*test.*"         | test, foo.test.bar, testing |
| internet.apn | "^internet\\.apn\$" | internet.apn                |

Regex

Regex for .corp APN: `^.*\\.suffix$`

```

subnet_map: %{
 # .corp APN
 "^.*\\.corp$" => ["10.100.0.0/16"],

 # .iot APN
 "^.*\\.iot$" => ["10.200.0.0/16"],

 default: ["42.42.42.0/24"]
}

```

Regex

| APN                | Regex           | IP Range       |
|--------------------|-----------------|----------------|
| ims                | ^ims            | 100.64.10.0/24 |
| ims.apn            | ^ims            | 100.64.10.0/24 |
| ims.something.else | ^ims            | 100.64.10.0/24 |
| m2m.test           | ^m2m\.          | 100.64.20.0/24 |
| m2m                | default         | 42.42.42.0/24  |
| enterprise.corp    | enterprise.corp | 10.100.0.0/16  |
| foo.corp           | ^.*\.corp\$     | 10.100.0.0/16  |
| unknown.apn        | default         | 42.42.42.0/24  |

Regex

**CIDR** <network>/<prefix\_length>

| CIDR | IP Count | IP Range                    |
|------|----------|-----------------------------|
| /24  | 254      | 100.64.1.1 - 100.64.1.254   |
| /23  | 510      | 100.64.0.1 - 100.64.1.254   |
| /22  | 1022     | 100.64.0.1 - 100.64.3.254   |
| /20  | 4094     | 100.64.0.1 - 100.64.15.254  |
| /16  | 65534    | 100.64.0.1 - 100.64.255.254 |

IP

- 100.64.1.0/24
- 100.64.1.255/24
- PGW-C `<network> + 1` `<broadcast> - 1`

## APN

```
config :pgw_c,
 ue: %{
 subnet_map: %{
 "internet" => [
 "100.64.1.0/24",
 "100.64.2.0/24",
 "100.64.3.0/24",
 "100.64.4.0/24"
]
 }
 }
}
```

- PGW-C
- 
- 

- 
- 
-

□□□□□□

```
config :pgw_c,
 ue: %{
 subnet_map: %{
 # □□□□□□
 "internet" => [
 "100.64.0.0/20" # 4094 □ IP □□□□□□
],

 # IMS□□□ LTE □□□□
 "ims" => [
 "100.64.16.0/22" # 1022 □ IP □□ IMS
],

 # □□ APN
 "enterprise.corp" => [
 "10.100.0.0/16" # 65534 □ IP □□□□
],

 # □□□□□□□□□□□□
 "iot.m2m" => [
 "100.64.20.0/22" # 1022 □ IP □□□□□□
],

 # □□□□
 default: [
 "42.42.42.0/24" # 254 □ IP □□□□ APN
]
 }
 }
}
```

## IPv6

```
config :pgw_c,
 ue: %{\br/> subnet_map: %{\br/> "internet" => [\br/> # IPv4
 "100.64.1.0/24"
],
 "internet.ipv6" => [\br/> # IPv6
 "2001:db8:1::/48"
],
 default: [\br/> "42.42.42.0/24"
]
 }
 }
}
```

## IPv6

- UE /64
- UE IP
- UE `2001:db8:1:a::/64`

## IPv4v6

```
config :pgw_c,
 ue: %{\br/> subnet_map: %{\br/> "internet" => [\br/> "100.64.1.0/24", # IPv4
 "2001:db8:1::/48" # IPv6
],
 }
 }
}
```

- UE 通过 PDN 连接 IPv4v6
  - PGW-C 支持 IPv4 和 IPv6 地址
  - 网络地址转换
- 

## 网络

IP 地址由 PGW-C 在 S5/S8 接口分配给 UE。GTP-C 在 S5/S8 接口使用 UDP 传输。

# IPv4

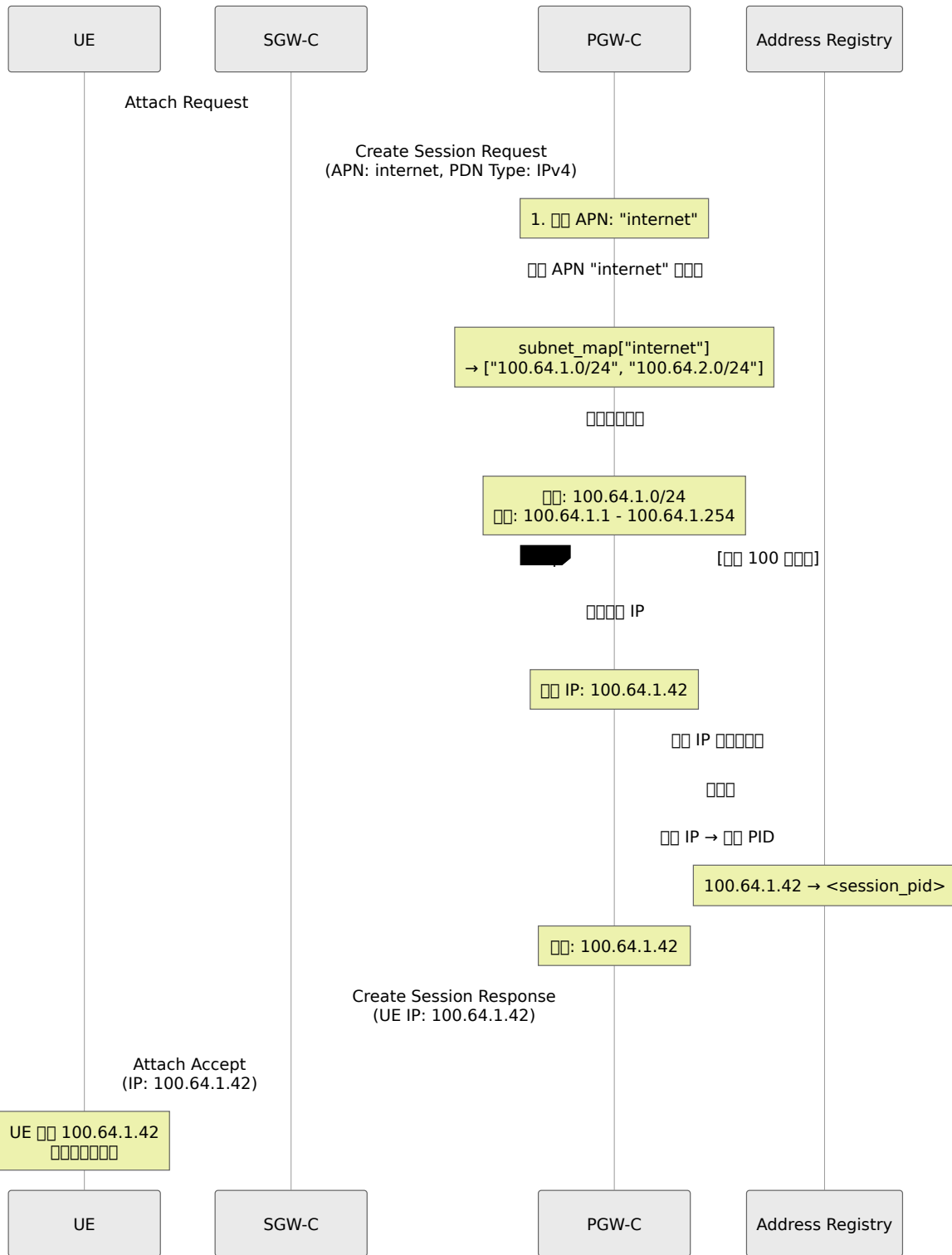

IPv4

IPv4

1. 查詢 查詢 APN 查詢
2. 查詢 查詢
3. **IP** 查詢 查詢 IP
4. 查詢 查詢 IP 查詢
5. 查詢 查詢 100 查詢 IP
6. 查詢 查詢 IP 查詢

查詢

- 查詢 **100** 查詢 查詢
- 查詢 查詢 IP 查詢
- 查詢 查詢
- 查詢 查詢 APN 查詢

查詢

查詢 查詢 IP

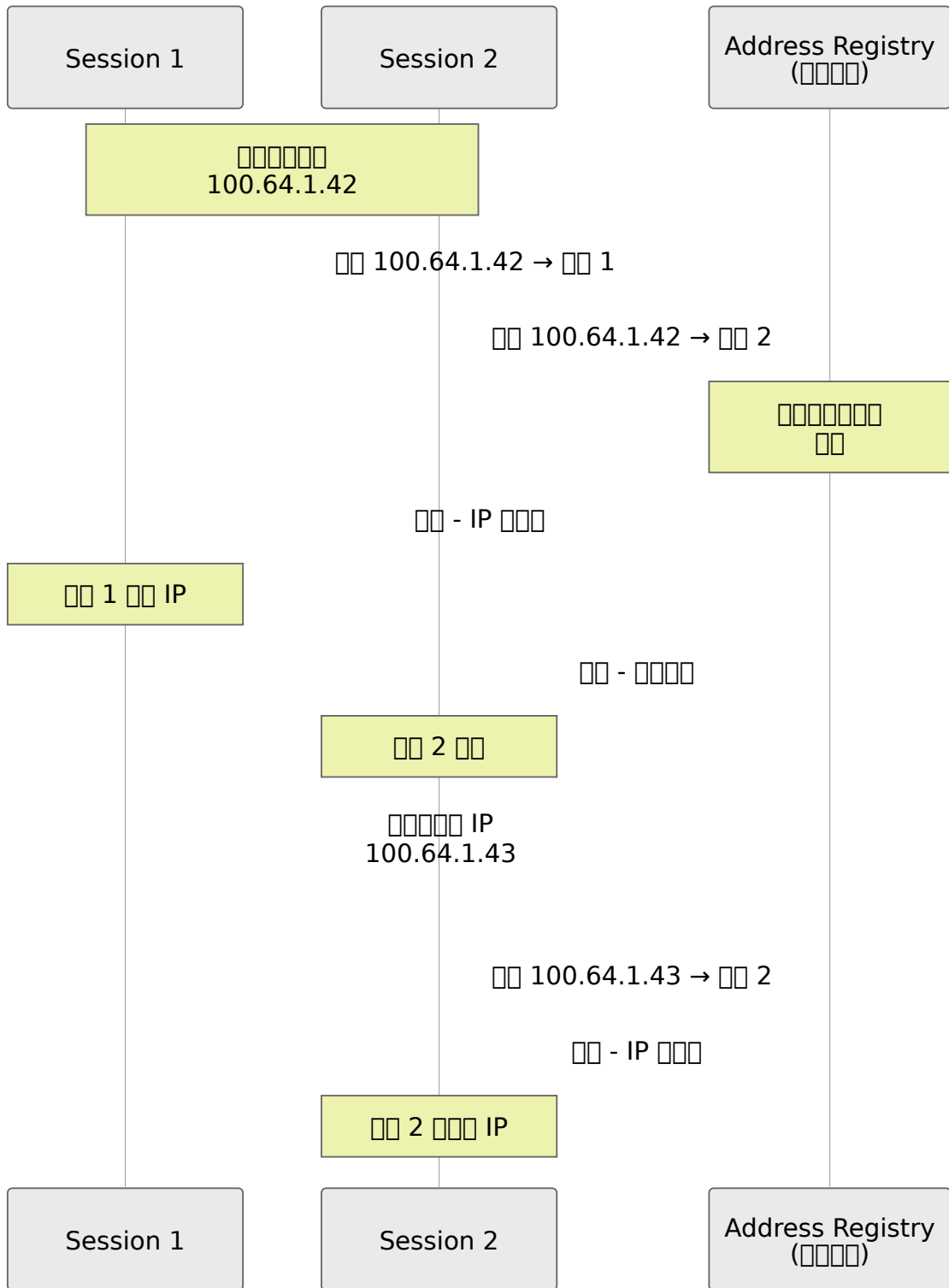

□□□□□□□□

- □□□□□□□□□□□□□□□□
- □□□□□□□□□□
- □□□□□□□□ IP □□
- □□□□□□□□ IP □□□□
- □□□□□□□□□□□□□□ IP

□□□□□□

□□□ UE □□□□ APN

□□□□□

```
□□
subnet_map: %{
 "internet" => ["100.64.1.0/24"],
 default: ["42.42.42.0/24"]
}
```

□□

- UE □□ APN: "unknown.apn"
- □□□ subnet\_map □□□ "unknown.apn"
- □□□□□□□□□□□□□□
- □ 42.42.42.0/24 □□ IP

□□□□□

1. □□□□□□□□□□□□□□ APN □□
2. □□□□□□□□□□ default □
3. □□□□□□□□□□□□□□

□□□□□□□□

OmniCharge

OmniRAN

Downloads

⌵ □□□□

OmniTouch Website [↗](#)

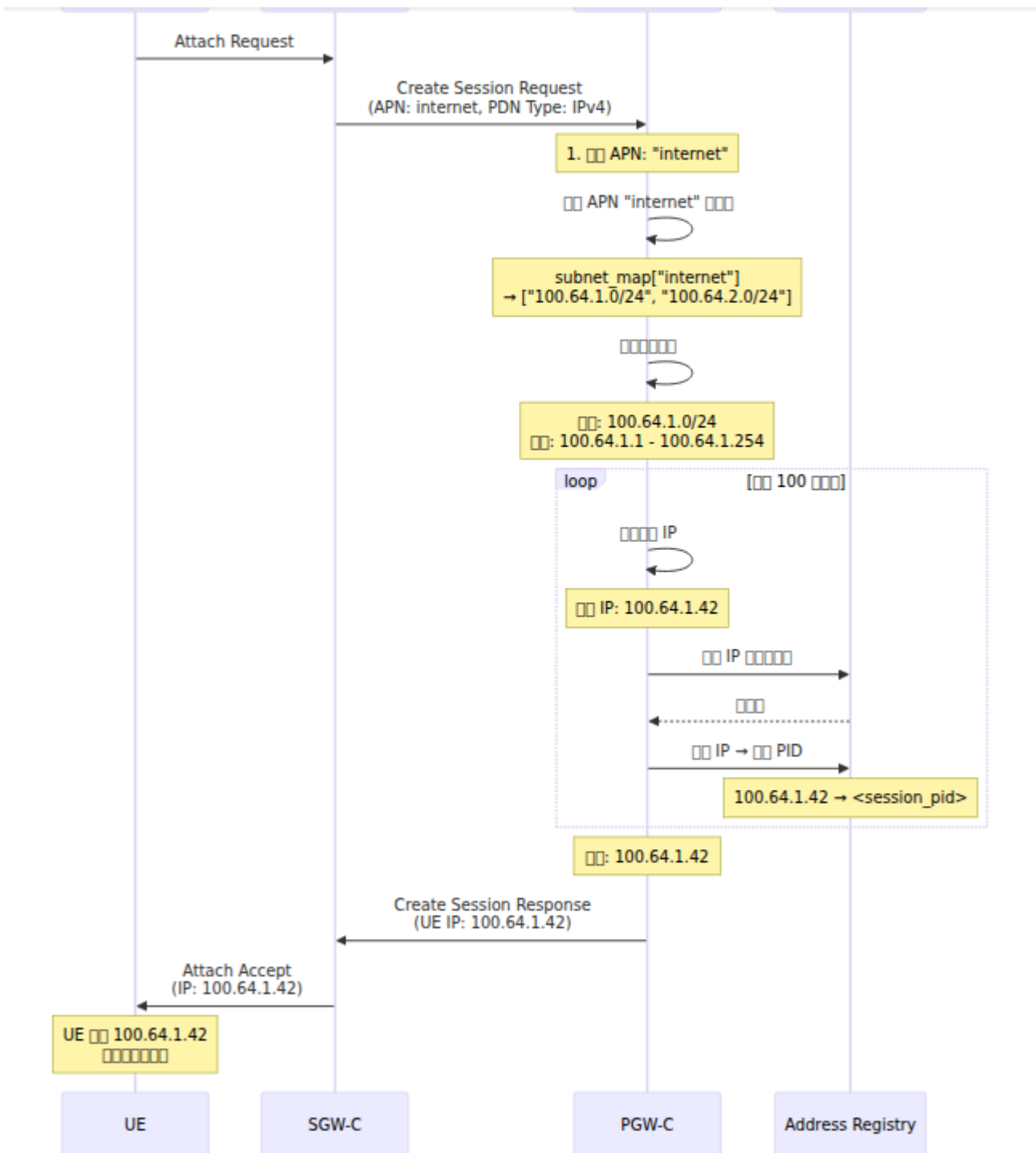

□□□□

- □□□□□□□□□□□□□□□□
- IP □□□□□□□□□□
- □□□□□□

## IP Pool

### Overview

IP Pool Management

```
IP: 100.64.1.0/24 (254 IP)
Pool: 254 IP
Usage: 100% → 254
```

### Configuration

1. PGW-C IP 100.64.1.0/24
2. IP Pool Management
3. Error: `{:error, :ue_ip_address_allocation_failed}`
4. IP Pool Usage
5. SGW-C IP Pool Management

### Configuration

```
IP Pool Management
address_registry_count / total_pool_size > 0.8 # 80% Usage

IP Pool Management
"internet" => [
 "100.64.1.0/24",
 "100.64.2.0/24", # IP Pool
 "100.64.3.0/24"
]
```

## IP Pool

IP Pool Management

**GTP-C** IP Pool

### Create Session Request

- |— IMSI: 310260123456789
- |— APN: enterprise.corp
- |— PDN 0000 (IE)
  - |   └─ PDN 00: IPv4
  - |   └─ IPv4 00: 10.100.0.50 ← UE 0000 IP

### OmniPGW 000

1. 00000 IP 0000000 PDN 0000 IE
2. 00 IP 000000 IP 00000 APN 000000
3. 0000000 00 IP 000000000000
4. 0000000
  - o 0000000000 IP 0000000
  - o 000000000000000000000000

### 0000000

- 000 UE 0000000000 IP 00
- 000IP 000000 000000 - IP 0000
- 000IP 0000000 000000 - IP 00000000

### IPv6 0000

### UE 00 IPv6

### Create Session Request

- |~~000~~— PDN 00: IPv6

### PGW-C 00 /64 000

Network: 2001:db8:1:a::/64

UE Network

- 2001:db8:1:a::1
- 2001:db8:1:a::2
- ... (18 quintillion)

Network

- UE Network IP Network
- SLAAC Network
- NAT Network

Network

**UE Network IPv4v6**

Create Session Request

└─ PDN Network: IPv4v6

**PGW-C Network**

IPv4: 100.64.1.42

IPv6: 2001:db8:1:a::/64

Network

- IPv4 Network IPv4 Network
- IPv6 Network IPv6 Network
- Network
- Network GTP Network

Network **IP** Network

Network **IP** Network **RFC 1918** Network

```
子网映射配置
subnet_map: %{
 "internet" => [
 "10.0.0.0/8",
 "172.16.0.0/12",
 "192.168.0.0/16"
]
}
```

配置 **PGW-U** 的 **NAT** 规则

配置 **IP** 池

```
配置 IP 池
subnet_map: %{
 "internet" => [
 "203.0.113.0/24" # 公网 IP 池
]
}
```

配置 **NAT** - 规则

配置

- 配置 **IP RFC 6598** 池 `100.64.0.0/10` 用于 NAT
- 配置 **IP** 池

配置

## Web UI - IP 池

OmniPGW 的 Web 界面 IP 池配置

配置 `http://<omnipgw-ip>:<web-port>/ip_pools`

□□□

### 1. □□□

- □□□□ IP □
- □□□□□□□□
- □□□□ IP
- □□□□□□□□

### 2. □□ **APN** □□□ □□□□□□□□

- □□□ - APN □□□□□□□□“default”□“ims.something.else”□“Internet”□
- **APN** □□ - □□□ APN □□□□
- **IP** □□ - □□□□□□□□ CIDR □□□
- □□□ - □□□□□□□□□□□□□□
- □□□□□
  - □□□□□□□□ IP □□
  - □□□□□□□□□□ IP
  - □□□□□□□□□□ IP

### 3. □□□□

- 2 个 IP
- 100 个 IP
- 100 个 IP

IP

- 100 个 IP
- 100 个 IP
- 100 个 IP
- 1 APN 100 个 IP

IP

100 个 IP

```
100 个 IP
address_registry_count

100 个 IP
address_registry_count / <total_pool_size> * 100
```

IP

```
IP: 100.64.1.0/24 (254 个 IP)
IP: 150 个 IP
IP: 150 / 254 = 59%
```

00

```
0000000000
- alert: UEIPPoolUtilizationHigh
 expr: address_registry_count > 200 # 00 /24 0
 for: 10m
 annotations:
 summary: "UE IP 000000 80%"
 description: "00: {{ $value }} / 254 0 IP 0000"

00000000
- alert: UEIPPoolExhausted
 expr: address_registry_count >= 254 # 00 /24 0
 for: 1m
 annotations:
 summary: "UE IP 000 - 0000 IP"

0000000000
- alert: UEIPAllocationFailures
 expr: rate(ue_ip_allocation_failures_total[5m]) > 0
 for: 5m
 annotations:
 summary: "UE IP 000000"
```

## Grafana 000

00 1 IP 0000

```
0000000000
(address_registry_count / 254) * 100
```

00 2 0000000000 IP

```
0000
address_registry_count
```

00 3 0000

```
查看速率
rate(address_registry_count[5m])
```

查看 4 小时速率

```
查看速率与总地址数之差
(254 - address_registry_count) / rate(address_registry_count[1h])
```

查看 IP

查看 1 小时内所有 IP

查看

- 查看速率 "速率"
- 查看 "UE IP 速率"

查看

1. 查看

```
查看速率
curl http://<pgw_c_ip>:42069/metrics | grep
address_registry_count
```

2. 查看

```
例
config :pgw_c,
 ue: %{
 subnet_map: %{
 "internet" => [
 "100.64.1.0/24" # CIDR
]
 }
 }
}
```

### 3. APN 例

```
APN 例
例
subnet_map: %{
 default: ["42.42.42.0/24"]
}
```

例

- 例
- PGW-C IP
- `runtime.exs`

### 2 IP 例

例

- UE IP
- 例

例

- 例

例

```
检查已经注册 IP
grep "already_registered" /var/log/pgw_c.log
```

检查

- 检查已经注册 IP
- 检查已经注册 IP

## 检查 3 个已经注册 IP

检查

- UE 已经注册 IP
- APN "internet" 和 "ims" 已经注册 IP

检查

- 检查已经注册 IP

检查

```
检查 APN 已经注册
subnet_map: %{
 "internet" => [...], # 检查
 "Internet" => [...], # 检查 APN!
}
```

检查

- 检查 APN 已经注册 IP
- 检查已经注册 IP

## 检查 4 个 IPv6 已经注册

检查

- UE 已经注册 IPv6 已经注册

□□□□

### 1. □□ IPv6 □

```
□□ IPv6 □
subnet_map: %{
 "internet" => [
 "100.64.1.0/24" # □ IPv4
]
}
```

### 2. □□ IPv6 □

```
□□□□□□ /48 □□□□
"internet" => [
 "2001:db8::/128" # □□ - □□□□□□
]
```

□□□□

```
□□ IPv6 □
subnet_map: %{
 "internet" => [
 "100.64.1.0/24",
 "2001:db8:1::/48" # IPv6 □
]
}
```

## □□ 5□□□□□□

□□

- □□□□
- `address_registry_count` □□□□

□□□□

### 1. □□□□

```
"internet" => [
 "100.64.1.0/24", # []
 "100.64.2.0/24", # [] 254 [] IP
 "100.64.3.0/24" # [] 254 [] IP
]
```

## 2. []

```
[] /24 [] /22
"internet" => [
 "100.64.0.0/22" # 1022 [] IP
]
```

## 3. []

- []
- []

[][][]

[][][]

[][][][][]

```
[][][]10,000
[][][]30%[]3,000 []
[][][]50%
[] IP[]3,000 * 1.5 = 4,500 [] IP
```

```
[][]/20[]4,094 [] IP - []
[][]/19[]8,190 [] IP - []
```

[][][]

[][]

- 100.64.0.0/10 RFC 6598 - NAT
- 400 IP
- NAT

□□□

- IP
- VPN

□□□□

```

config :pgw_c,
 ue: %{
 subnet_map: %{
 # APN -
 "internet" => [
 "100.64.0.0/18" # 16,382 IP
],

 # IMS -
 "ims" => [
 "100.64.64.0/22" # 1,022 IP
],

 # -
 "enterprise.corp" => [
 "100.64.68.0/22" # 1,022 IP
],

 # -
 "iot.m2m" => [
 "100.64.72.0/20" # 4,094 IP
],

 # -
 default: [
 "100.64.127.0/24" # 254 IP
]
 }
 }

```

---

## □□□□

### □□

- □□□□ - UE IP □□□□APN □□□□
- **PCO** □□ - □ IP □□□□□□□□ DNS□P-CSCF□MTU
- □□□□ - □□□□□□□□PDN □□□□□ IP □□
- **PFCP** □□ - □□ PFCP □ UPF □□ UE □□

### □□□□

- **S5/S8** □□ - □□ GTP-C □□ IP □□
- **Diameter Gx** □□ - IP □□□□□□□□

### □□

- □□□□ - IP □□□□□□□□□□□□
- □□ **CDR** □□ - CDR □□ UE IP □□□□□□□□

---

## □□□□□□

# OmniPGW 部署

## OmniPGW - 部署 (PGW-C)

OmniPGW 部署

---

### 部署

1. 部署
  2. 部署
  3. 部署
  4. 部署
  5. 部署
  6. 部署
  7. Web UI - 部署
  8. 部署
  9. 部署
  10. 部署
  11. 部署
  12. 部署
- 

### 部署

OmniPGW 部署 (PGW-C) 部署 3GPP LTE 部署 (EPC) 部署  
OmniPGW 部署

- 部署 - 部署 (UE) 部署
- IP 部署 - 部署 IP 部署
- 部署 - 部署 PCRF 部署
- 部署 - 部署 PGW-U (部署) 部署

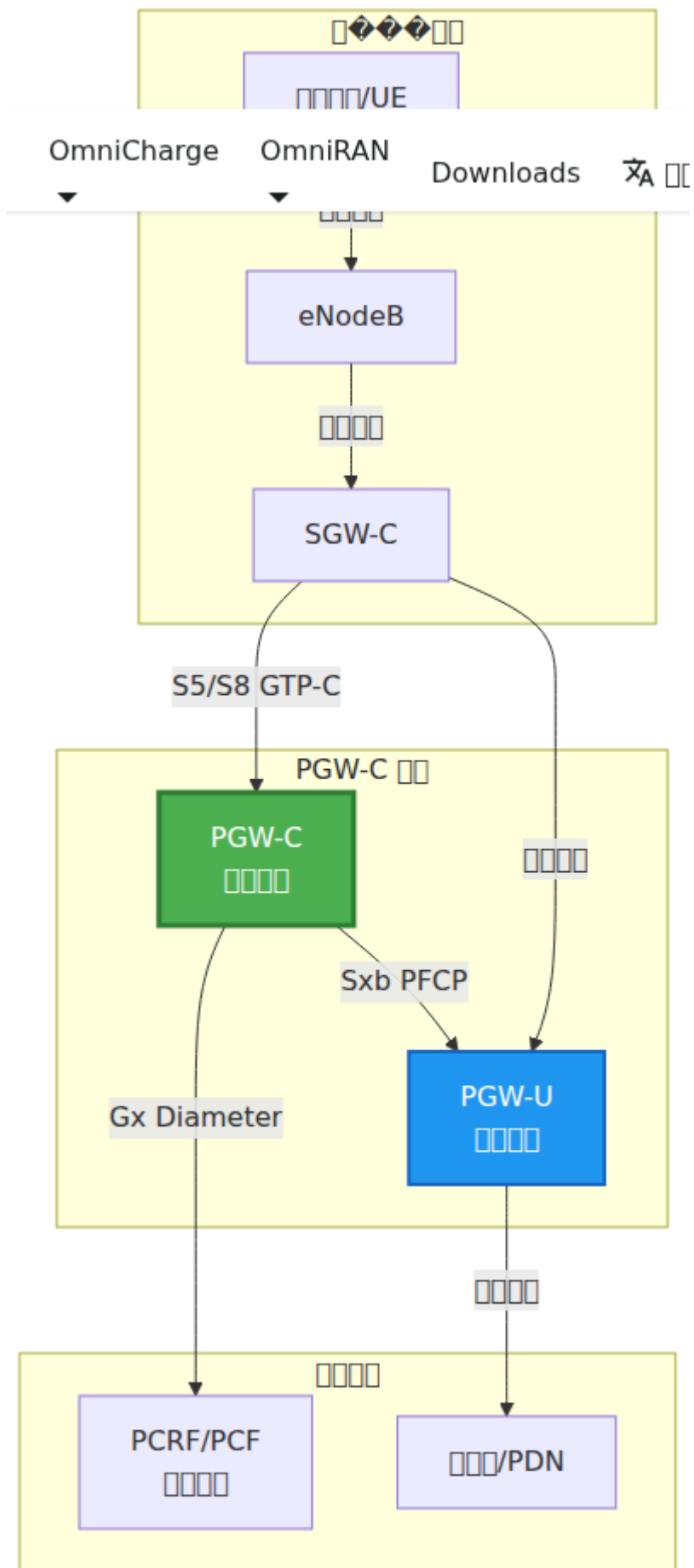

## PGW-C

- **SGW-C** S5/S8 (GTP-C)
  - **UE IP**
  - **Gx (Diameter) PCRF**
  - **Sxb (PFCP) PGW-U**
  - **QoS QoS**
  -
-

□□



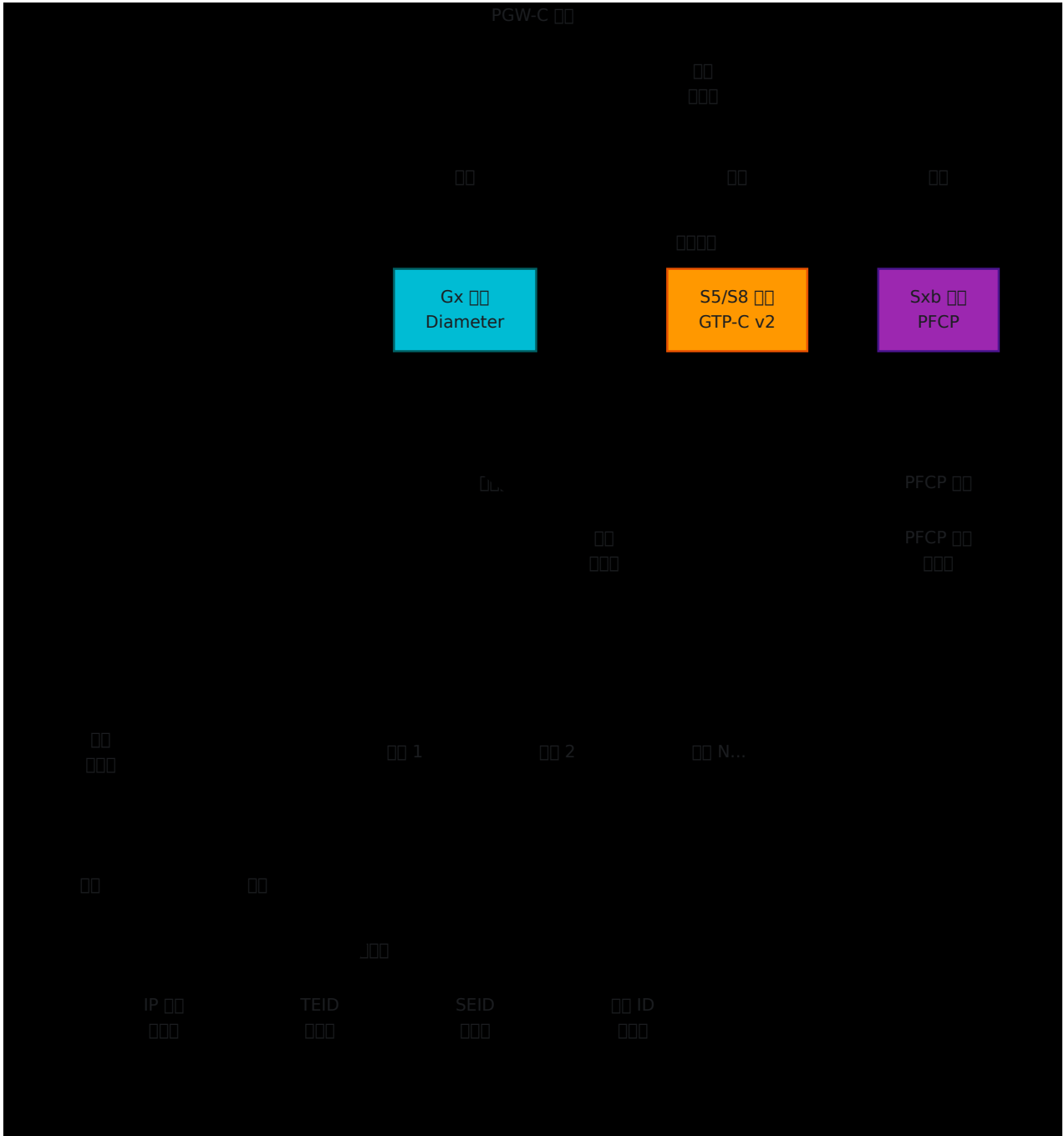











□□□□



□□□□

PGW-C □□ Elixir/OTP □□□□□□□□□□□□

- □□□□□ - □□□□□□□□□□□□

-  -  - 
-  -  PDN  GenServer
-  -  (IP  TEID  SEID 
- **PFCP**  -  PGW-U  PFCP 

---









PGW-C  3GPP 

## **S5/S8** (**GTP-C v2**)

 SGW-C  PGW-C 

  UDP  GTP-C  2

-  
-  
-  
-  

  **S5/S8** 

## **Sxb** (**PFCP**)

 PGW-C  PGW-U 

  UDP  PFCP (

-  
-  

- 3GPP TS 23.002/3GPP
- 3GPP TS 23.002/3GPP
- 3GPP TS 23.002/3GPP

3GPP TS 23.002 PFCP/Sxb 3GPP

## Gx (Diameter)

3GPP TS 23.002 (PCRF) 3GPP

3GPP Diameter (IETF RFC 6733)

3GPP

- 3GPP TS 23.002 (CCR-I/CCA-I)
- 3GPP TS 23.002 (CCR-T/CCA-T)

3GPP TS 23.002 Diameter Gx 3GPP

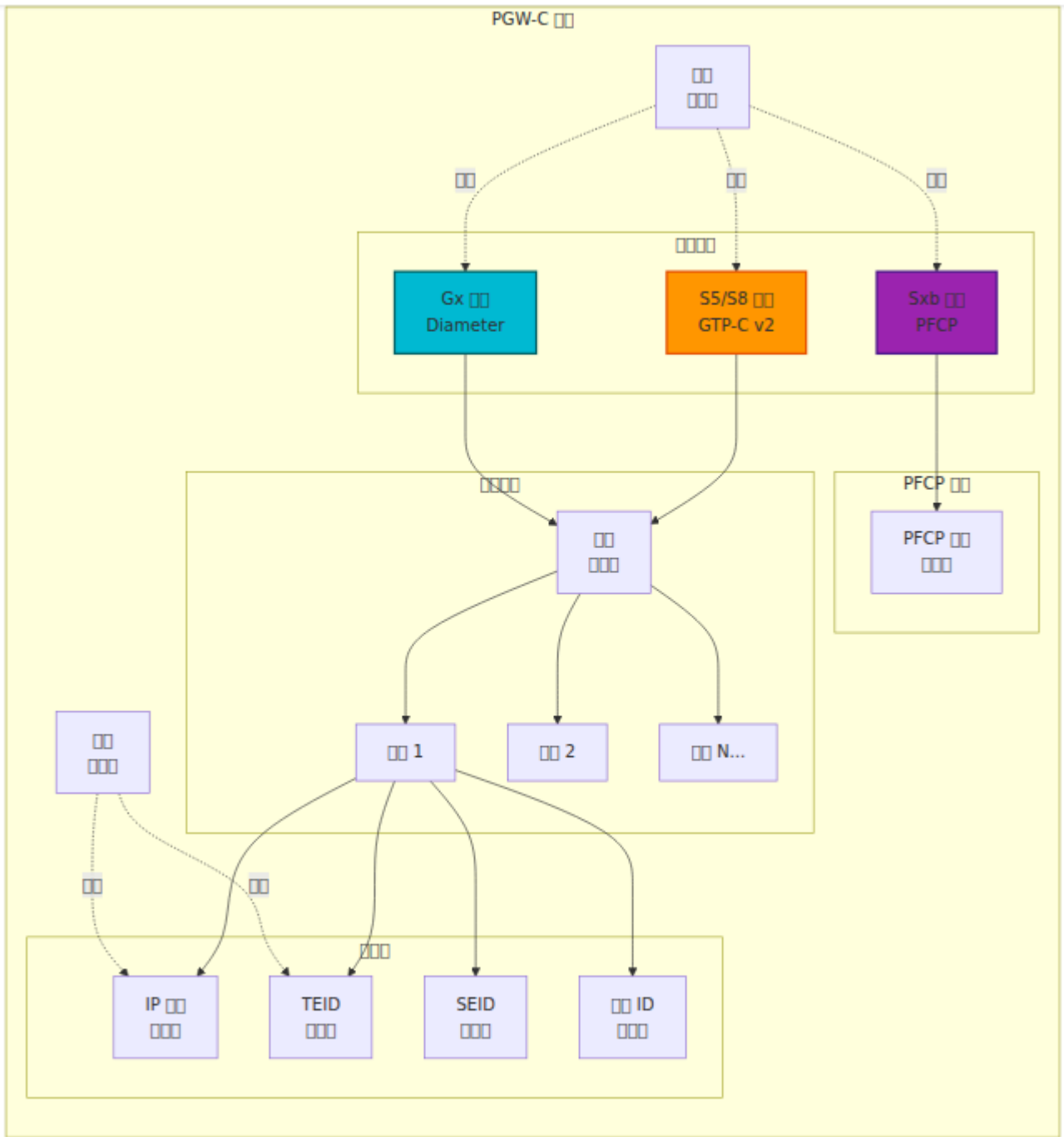

□□□□

## PDN □□

PDN (□□□□□□□□) □□□□ UE □□□□□ (□□□□□) □□□□□□□□□□□□□□

- **UE IP** □□ - □□□□□□□□□□□□

- **APN** (Access Point Name) - 网络标识符
- **QoS** (Quality of Service) - 服务质量
- **ID** - 标识符
- **TEID** (Tunnel Endpoint ID) - S5/S8 隧道端点标识符
- **SEID** (Service ID) - Sxb 服务标识符

## 网络标识符

网络标识符 QoS 网络标识符

- **PDN** (PDN Type) - PDN 类型
- **QoS** (QoS Class Identifier) - QoS 类别标识符
- **EBI** (EPS Bearer ID) - EPS 承载标识符
- **QoS** (QoS Class Identifier) - QCI/ARF (MBR/GBR)

## PFCP 网络

PGW-C 与 PGW-U 网络标识符

- **PDR** (Policy Decision Rule) - 策略决策规则 (规则/规则)
- **FAR** (Forwarding Action Rule) - 转发动作规则
- **QER** (QoS Enforcement Rule) - QoS 执行规则
- **BAR** (Bandwidth Allocation Rule) - 带宽分配规则

网络标识符 **PFCP** 网络标识符

## IP 网络

UE IP 网络标识符

- **APN** (Access Point Name) - APN 网络标识符
- **IP** (IP Address) - IP 地址
- **UE** (User Equipment) - UE IP 地址
- **IP** (IP Address) - IP 地址

网络标识符 **UE IP** 网络标识符

---

□□

□□□□

- Elixir ~1.16
- Erlang/OTP 26+
- □ SGW-C□PGW-U □ PCRF □□□□
- □ LTE EPC □□□□

## □□ OmniPGW

1. □ `config/runtime.exs` □□□□□□□□

2. □□□□□□□□

```
mix deps.get
mix compile
```

3. □□□□□□□□

```
mix run --no-halt
```

□□□□

□□□□□□□□□□□□

```
[info] □□ OmniPGW...
[info] □ 127.0.0.42:42069 □□□□□□□□
[info] □ 127.0.0.10 □□ S5/S8 □□
[info] □ 127.0.0.20 □□ Sxb □□
[info] □□ Gx □□
[info] □□ PFCP □□□□□□
[info] OmniPGW □□□□
```

□□□□□ □ `http://127.0.0.42:42069/metrics` (□□□□□□)□

---



## Web UI

http://<omnipgw-ip>:<web-port>/

Table

| Category        | URL              | Description          | Count |
|-----------------|------------------|----------------------|-------|
| <b>UE</b>       | /ue_search       | UE Search            | 1     |
| <b>PGW</b>      | /pgw_sessions    | PGW Sessions PDN     | 2     |
|                 | /session_history | Session History      | 5     |
|                 | /topology        | Topology             | 5     |
| <b>IP</b>       | /ip_pools        | UE IP Pools          | 2     |
| <b>PFCP</b>     | /pfcf_sessions   | PGW-U PFCP           | 2     |
| <b>UPF</b>      | /upf_status      | UPF PFCP             | 2     |
| <b>UPF</b>      | /upf_selection   | UPF Selection P-CSCF | 1     |
| <b>Diameter</b> | /diameter        | PCRF                 | 1     |
| <b>P-CSCF</b>   | /pcscf_monitor   | P-CSCF DNS           | 5     |
| <b>Gy</b>       | /gy_simulator    | Gy/Ro Simulator      | 1     |
|                 | /cell_towers     | OpenCellID           | 1     |
|                 | /logs            | Logs                 | 1     |

## □□□□

### □□□□

- □□□□□□□□ (□□□□□□□□)
- □□ OmniPGW □□□□□□□□
- □□□□□□□□□□ (□□/□□)

### □□□□□□

- □ IMSI□IP□MSISDN □ APN □□□□
- □□□□□□□□□□□□□□

### □□□□□□□□

- □□□□□□□□□□□□□□
- □□□□□□□□
- □□□□□□□□□□

### □□□□□□ (□□□□)□

- □□□□□□□□□□
- □□□□ NOC/□□□□□□□□
- □□□□□□ IP □□□□□□

## □□□□□□□□

### □□□□□□ (□□□□)□

1. `GET /ue_search`
2. `POST /ue_search`
3. `GET /imsi/MSISDN/IP`
4. `POST /ue_search`
  - a) `imsi` - IMSI
  - b) `tac` - TAC ID
  - c) `qci` - QCI
    - `qci` MBR/GBR
    - `apn` AMBR
  - d) `gy` - Gy ID
  - e) `gx` - Gx PCC
  - f) `pcrf` - PCRF
5. `POST /ue_search` → `POST /diameter` PCRF
6. `POST /ue_search` → `POST /ue_search`

#### PGW Sessions

1. `GET /pgw_sessions`
2. `POST /pgw_sessions`
3. `GET /imsi`
4. `POST /pgw_sessions`
  - `ue_ip` UE IP
  - `qos` QoS
  - `apn` APN
5. `POST /pgw_sessions` → `POST /pgw_sessions` UE

#### UPF Sessions

1. `POST /upf_sessions` → `POST /pgw_u` "imsi"
2. `POST /diameter` → `POST /pcrf` "imsi"
3. `POST /pgw_sessions` → `POST /upf_sessions`

#### PGW Sessions

- `POST /pgw_sessions`
- `POST /pgw_sessions`
- `POST /pgw_sessions`
- `POST /apn`

# Web UI

## Web UI

- (UE)
- 
- (PFCP/Diameter)
- 
- IMSI/MSISDN/IP
- ()
- QoS (MBR/GBR/QCI)
- 
- 
- IP
- 

## Prometheus

- 
- 
- 
- 
- 

- Web UI Prometheus

---

## 

Web UI OmniPGW Prometheus

## 

-

- `teid_registry_count` - S5/S8
  - `seid_registry_count` - PCFP
  - `session_id_registry_count` - Gx
  - `address_registry_count` - UE IP
  - `charging_id_registry_count` - ID
- - `s5s8_inbound_messages_total` - GTP-C
  - `sxb_inbound_messages_total` - PCFP
  - `gx_inbound_messages_total` - Diameter
  -
- - `s5s8_inbound_errors_total` - S5/S8
  - `sxb_inbound_errors_total` - PCFP
  - `gx_inbound_errors_total` - Diameter

HTTP

```
curl http://127.0.0.42:42069/metrics
```

OmniPGW

# 目次

```
OmniPGW 目次
├── OPERATIONS.md (目次)
├── docs/
│ ├── 目次
│ │ ├── configuration.md 目次 runtime.exs 目次
│ │ ├── ue-ip-allocation.md IP 目次
│ │ └── pco-configuration.md DNS/P-CSCF/MTU 目次
│ ├── 目次
│ │ ├── pfcg-interface.md Sxb/PFCP (PGW-U 目次)
│ │ ├── diameter-gx.md Gx (PCRF 目次)
│ │ ├── diameter-gy.md Gy/Ro (OCS 目次)
│ │ └── s5s8-interface.md S5/S8 (SGW-C 目次)
│ └── 目次
│ ├── session-management.md PDN 目次
│ └── monitoring.md Prometheus 目次
```

## 目次

目次

| 目次                   | 目次      | 目次 |
|----------------------|---------|----|
| <b>OPERATIONS.md</b> | 目次 (目次) | 目次 |

目次

| 파일명                                  | 주요 내용                    | 라인 수   |
|--------------------------------------|--------------------------|--------|
| <a href="#">configuration.md</a>     | runtime.exs 관련 설정        | 1,600+ |
| <a href="#">ue-ip-allocation.md</a>  | UE IP 할당 관련              | 943    |
| <a href="#">pco-configuration.md</a> | 정책 설정 (DNS, P-CSCF, MTU) | 344    |

#### 네트워크 인터페이스

| 파일명                                | 주요 내용                      | 라인 수   |
|------------------------------------|----------------------------|--------|
| <a href="#">pfcsp-interface.md</a> | PFCP/Sxb 관련 PGW-U          | 1,355  |
| <a href="#">diameter-gx.md</a>     | Diameter Gx 관련 PCRF (정책)   | 941    |
| <a href="#">diameter-gy.md</a>     | Diameter Gy/Ro 관련 OCS (요금) | 1,100+ |
| <a href="#">s5s8-interface.md</a>  | GTP-C S5/S8 관련 SGW-C       | 456    |

#### 관리 및 모니터링

| 파일명                                   | 주요 내용                  | 라인 수 |
|---------------------------------------|------------------------|------|
| <a href="#">session-management.md</a> | PDN 세션 관리              | 435  |
| <a href="#">monitoring.md</a>         | Prometheus, Grafana 관련 | 807  |
| <a href="#">data-cdr-format.md</a>    | CDR 관련 URR 관련          | 847  |
| <a href="#">qos-bearers.md</a>        | QoS 관련                 | 448  |
| <a href="#">troubleshooting.md</a>    | 문제 해결 가이드              | 687  |

#### 기타

| 項目                                  | 項目        | 項目  |
|-------------------------------------|-----------|-----|
| <a href="#">pcscf-monitoring.md</a> | P-CSCF 監視 | 894 |

目次

## Mermaid

Mermaid のインストール

- インストール
- インストール (Linux)
- インストール
- インストール

目次

インストール

- インストール
- インストール
- インストール

目次

インストール

- インストール
- インストール
- インストール

目次

インストール

## □□□□

### □□□□□□

1. OPERATIONS.md - □□ (□□□)
2. configuration.md - □□
3. monitoring.md - □□
4. session-management.md - □□□□

### □□□□□□

1. OPERATIONS.md - □□□□ (□□□)
2. pfcg-interface.md - □□□□□□
3. diameter-gx.md - □□□□
4. diameter-gy.md - □□□□
5. s5s8-interface.md - □□□□
6. ue-ip-allocation.md - IP □□

### □□□□□□

1. configuration.md - □□□□
2. ue-ip-allocation.md - IP □
3. pco-configuration.md - □□□□
4. monitoring.md - □□□□

## □□□□

- □□□□ 14
- □□□□ ~10,900+
- □□□□ ~265 KB
- **Mermaid** □□□ 75+
- □□□□□ 150+

## □□□□□□□

□□

- □ □□/□□□□□□
- □ OTP/Elixir □□
- □ □□□□
- □ □□ GenServer □□□

□□

- □ PFCP (□□□□□□□□□□)
- □ GTP-C v2 (GPRS □□□□)
- □ Diameter (RFC 6733)

### 3GPP □□

- □ Sxb (PGW-C ↔ PGW-U)
- □ Gx (PGW-C ↔ PCRF)
- □ Gy/Ro (PGW-C ↔ OCS)
- □ S5/S8 (SGW-C ↔ PGW-C)

□□

- □ □□□□
  - □ IP □□□□
  - □ QoS □□
  - □ □□□□
  - □ □□□□□
-

□□□□

## 3GPP □□

| □□        | □□                    |
|-----------|-----------------------|
| TS 29.274 | GTP-C v2 (S5/S8 □□)   |
| TS 29.244 | PFPCP (Sxb □□)        |
| TS 29.212 | Diameter Gx □□ (□□□□) |
| TS 32.299 | Diameter □□□□ (Gy/Ro) |
| TS 32.251 | □□□□□□□□              |
| TS 23.401 | EPC □□                |

□□□□

- □□□□ [config/runtime.exs](#)
-