

OmniUPF API

Documentation

Overview

The OmniUPF API provides a comprehensive RESTful interface for managing and monitoring the eBPF-based User Plane Function. The API enables real-time control and observability of all UPF components.

API Capabilities

Session Management:

- **PFCP Sessions:** Query active sessions, view session details, filter by UE IP or TEID
- **PFCP Associations:** Monitor control plane node associations and status

Traffic Rules:

- **Packet Detection Rules (PDR):** Inspect uplink and downlink traffic classifiers (IPv4/IPv6)
- **Forwarding Action Rules (FAR):** View forwarding, buffering, and drop policies
- **QoS Enforcement Rules (QER):** Monitor rate limiting and QoS policies
- **Usage Reporting Rules (URR):** Track data volume counters per session

Packet Buffering:

- **Buffer Status:** View buffered packets per FAR (`GET /buffer`, `GET /buffer/:far_id`)
- **Buffer Operations:** Flush or clear buffered packets (`POST /buffer/:far_id/flush`, `DELETE /buffer/:far_id`, `DELETE /buffer`)

- **Buffering Control:** Manual notification triggering (POST /buffer/:far_id/notify)
- **Notification Status:** View DLDR notification state (GET /buffer/notifications)

Monitoring and Statistics:

- **Packet Statistics:** Real-time packet counters by protocol (GTP, IP, TCP, UDP, ICMP, ARP)
- **XDP Statistics:** Datapath performance metrics (pass, drop, redirect, abort)
- **N3/N6 Interface Stats:** RAN and Data Network traffic distribution
- **Route Statistics:** FIB lookup performance (cache hits, lookups, errors)

Route Management:

- **UE Routes:** Query UE IP to gNB routing table (GET /routes)
- **FRR Integration:** Synchronize routes with Free Range Routing daemon (POST /routes/sync)
- **Routing Sessions:** View routing protocol sessions (GET /routing/sessions)
- **OSPF Database:** Query OSPF external route database (GET /ospf/database/external)

Configuration:

- **UPF Config:** Retrieve and edit configuration (GET /config, POST /config)
- **Dataplane Config:** Query dataplane-specific configuration (GET /dataplane_config)
- **XDP Capabilities:** Query XDP mode support and interface capabilities (GET /xdp_capabilities)
- **eBPF Map Capacity:** Monitor resource utilization and capacity (GET /map_info)

Web UI Integration

The OmniUPF Web UI is built on this API and provides an interactive dashboard for all API functionality. See the [Web UI Guide](#) for screenshots and usage

examples.

Swagger API Documentation

The API is fully documented using **OpenAPI 3.0 (Swagger)** specification. The interactive Swagger UI provides:

- Complete endpoint documentation with request/response schemas
- Try-it-out functionality for testing API calls directly from the browser
- Schema definitions for all data models
- HTTP status codes and error responses

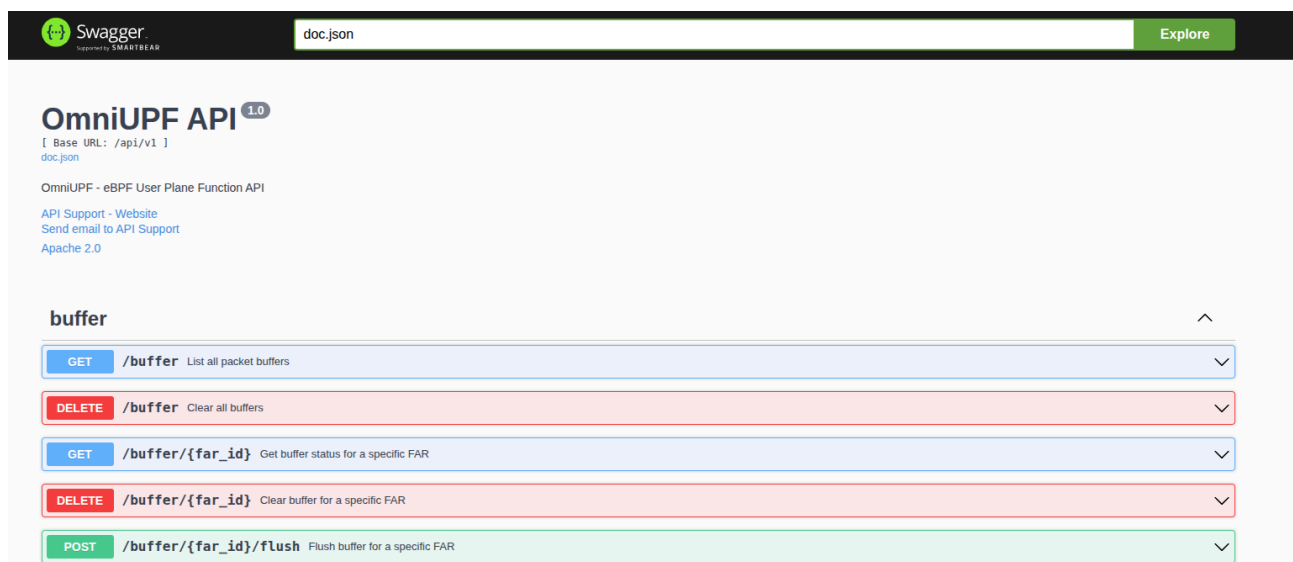

Interactive Swagger UI showing the OmniUPF API endpoints with detailed documentation.

Accessing Swagger UI

The Swagger documentation is available at:

```
http://<upf-host>:8080/swagger/index.html
```

For example: `http://10.98.0.20:8080/swagger/index.html`

API Base Path

All API endpoints are prefixed with:

```
/api/v1
```

```
## API Features
```

```
### Pagination
```

OmniUPF API supports pagination for endpoints that return large datasets. Pagination prevents timeouts and reduces memory usage when querying thousands of sessions, PDRs, or URRs.

Supported Pagination Styles:

- Page-based pagination** (recommended):
 - ``page``: Page number (starting from 1)
 - ``page_size``: Items per page (default: 100, max: 1000)
- Offset-based pagination**:
 - ``offset``: Number of items to skip
 - ``limit``: Number of items to return (max: 1000)

Example Requests:

```
```bash
Page-based: Get second page with 50 items per page
GET /api/v1/pfcp_sessions?page=2&page_size=50

Offset-based: Skip first 100 items, return next 50
GET /api/v1/pfcp_sessions?offset=100&limit=50

Default behavior (no pagination params): First 100 items
GET /api/v1/pfcp_sessions
```

**Response Format:**

```

 {
 "data": [
 { /* session object */ },
 { /* session object */ },
 ...
],
 "pagination": {
 "total": 5432,
 "page": 2,
 "page_size": 50,
 "total_pages": 109
 }
 }

```

### Paginated Endpoints:

- `/api/v1/pfcp_sessions` - PFCP sessions list
- `/api/v1/pfcp_associations` - PFCP associations list
- `/api/v1/routes` - UE IP routes
- `/api/v1/uplink_pdr_map` - Uplink PDRs (basic info)
- `/api/v1/uplink_pdr_map/full` - Uplink PDRs with full SDF filter details
- `/api/v1/downlink_pdr_map` - Downlink PDRs IPv4 (basic info)
- `/api/v1/downlink_pdr_map/full` - Downlink PDRs IPv4 with full SDF filter details
- `/api/v1/downlink_pdr_map_ip6` - Downlink PDRs IPv6 (basic info)
- `/api/v1/downlink_pdr_map_ip6/full` - Downlink PDRs IPv6 with full SDF filter details
- `/api/v1/far_map` - Forwarding Action Rules
- `/api/v1/qer_map` - QoS Enforcement Rules
- `/api/v1/urr_map` - Usage Reporting Rules

### Buffer Management Endpoints:

- `GET /api/v1/buffer` - List all FAR buffers with statistics
- `GET /api/v1/buffer/:far_id` - Get buffer status for specific FAR
- `GET /api/v1/buffer/notifications` - List DLDR notification status
- `DELETE /api/v1/buffer` - Clear all buffered packets

- `DELETE /api/v1/buffer/:far_id` - Clear buffer for specific FAR
- `POST /api/v1/buffer/:far_id/flush` - Flush (replay) buffered packets
- `POST /api/v1/buffer/:far_id/notify` - Manually send DLDR notification

### Configuration Endpoints:

- `GET /api/v1/config` - Get current UPF configuration
- `POST /api/v1/config` - Update UPF configuration (runtime editable fields)
- `GET /api/v1/dataplane_config` - Get dataplane-specific configuration

### Routing Integration Endpoints:

- `GET /api/v1/routes` - List UE routes
- `POST /api/v1/routes/sync` - Trigger route synchronization with FRR
- `GET /api/v1/routing/sessions` - Get routing protocol sessions
- `GET /api/v1/ospf/database/external` - Get OSPF external LSA database

### Best Practices:

- Use `page_size=100` for Web UI display
- Use `page_size=1000` for bulk exports (max limit)
- Query `pagination.total_pages` to determine iteration count
- Increase `page_size` for better API performance (fewer requests)

## CORS Support

Cross-Origin Resource Sharing (CORS) is enabled by default for all API endpoints, allowing Web UI and third-party applications to consume the API from different origins.

## Prometheus Metrics

In addition to the REST API, OmniUPF exposes Prometheus metrics on the `/metrics` endpoint (default port `:9090`).

Metrics provide:

- PFCP message counters and latency per peer
- Packet statistics by protocol type
- XDP action verdicts
- Buffer statistics
- eBPF map capacity utilization
- URR volume tracking

See the [Metrics Reference](#) for complete documentation.

## Related Documentation

- [Web UI Guide](#) - Interactive dashboard built on this API
- [Metrics Reference](#) - Prometheus metrics documentation
- [PFCP Cause Codes](#) - PFCP error codes and troubleshooting
- [Rules Management Guide](#) - PDR, FAR, QER, URR configuration
- [Route Management Guide](#) - FRR integration and UE routing
- [Monitoring Guide](#) - Statistics monitoring and capacity planning
- [Configuration Guide](#) - UPF configuration options
- [Swagger UI](#) - Interactive API documentation (replace `localhost` with your UPF host)

# OmniUPF Architecture Guide

## Table of Contents

1. [Overview](#)
2. [eBPF Technology Foundation](#)
3. [XDP Datapath](#)
4. [Packet Processing Pipeline](#)
5. [eBPF Map Architecture](#)
6. [Buffering Mechanism](#)
7. [QoS Enforcement](#)
8. [Performance Characteristics](#)
9. [Scalability and Tuning](#)

## Overview

OmniUPF leverages eBPF (extended Berkeley Packet Filter) and XDP (eXpress Data Path) to achieve carrier-grade performance for 5G/LTE packet processing. By running packet processing logic directly in the Linux kernel, OmniUPF eliminates the overhead of userspace processing and achieves multi-gigabit throughput with microsecond latency.

# Architecture Layers

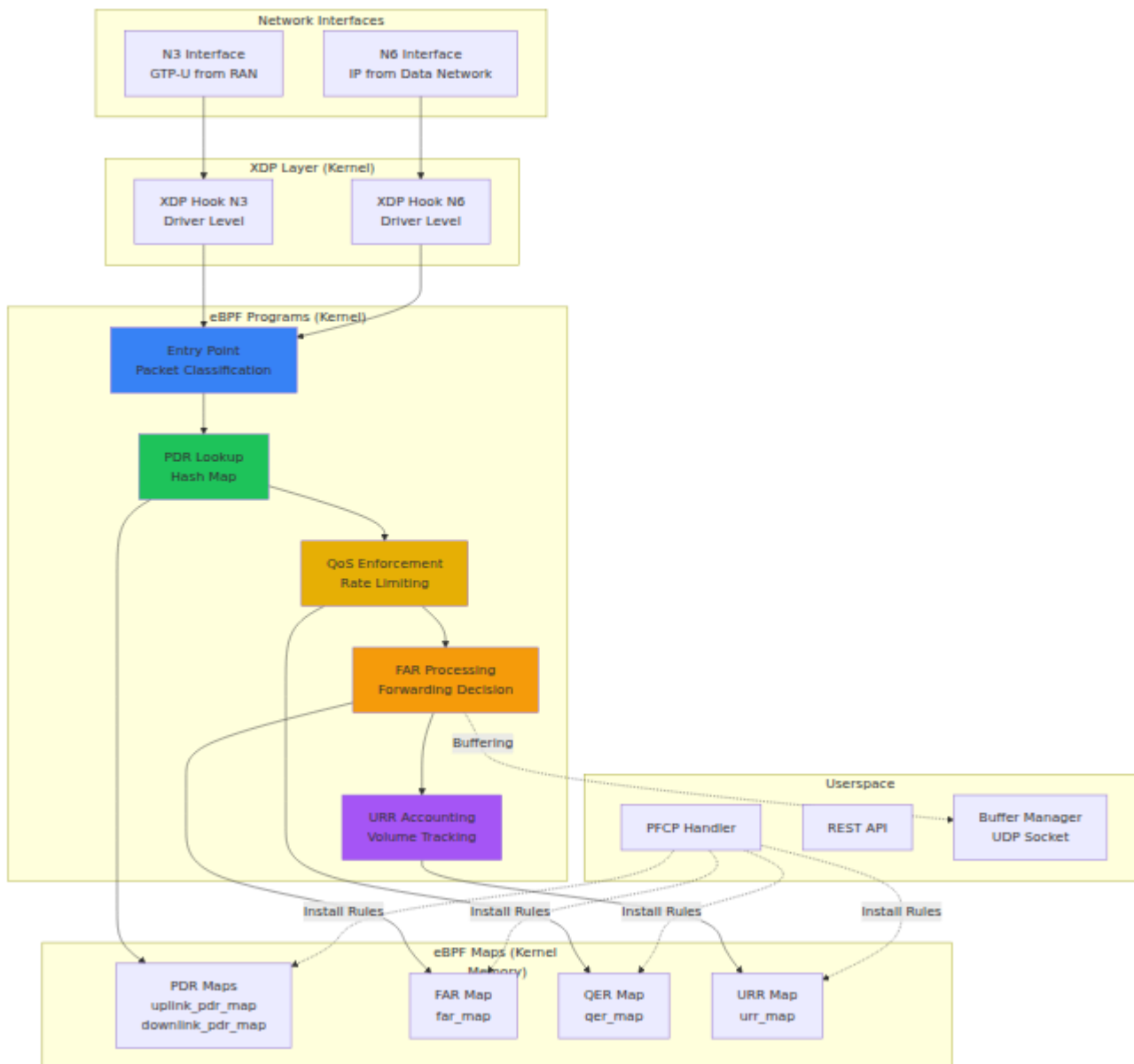

## Key Design Principles

### Zero-Copy Processing:

- Packets processed entirely in kernel space
- No data copying between kernel and userspace
- Direct packet manipulation using XDP

### Lock-Free Data Structures:

- eBPF maps use per-CPU hash tables

- Atomic operations for concurrent access
- No mutex/spinlock overhead

### **Hardware Offload Ready:**

- XDP offload mode supports SmartNIC execution
- Compatible with network cards supporting XDP
- Fallback to driver-native or generic modes

# **eBPF Technology Foundation**

## **What is eBPF?**

eBPF (extended Berkeley Packet Filter) is a revolutionary Linux kernel technology that allows safe, sandboxed programs to run in kernel space without changing kernel source code or loading kernel modules.

### **Key Features:**

- **Safety:** eBPF verifier ensures programs cannot crash the kernel
- **Performance:** Runs at native kernel speed (no interpretation overhead)
- **Flexibility:** Can be updated at runtime without kernel restart
- **Observability:** Built-in tracing and statistics

# eBPF Program Lifecycle

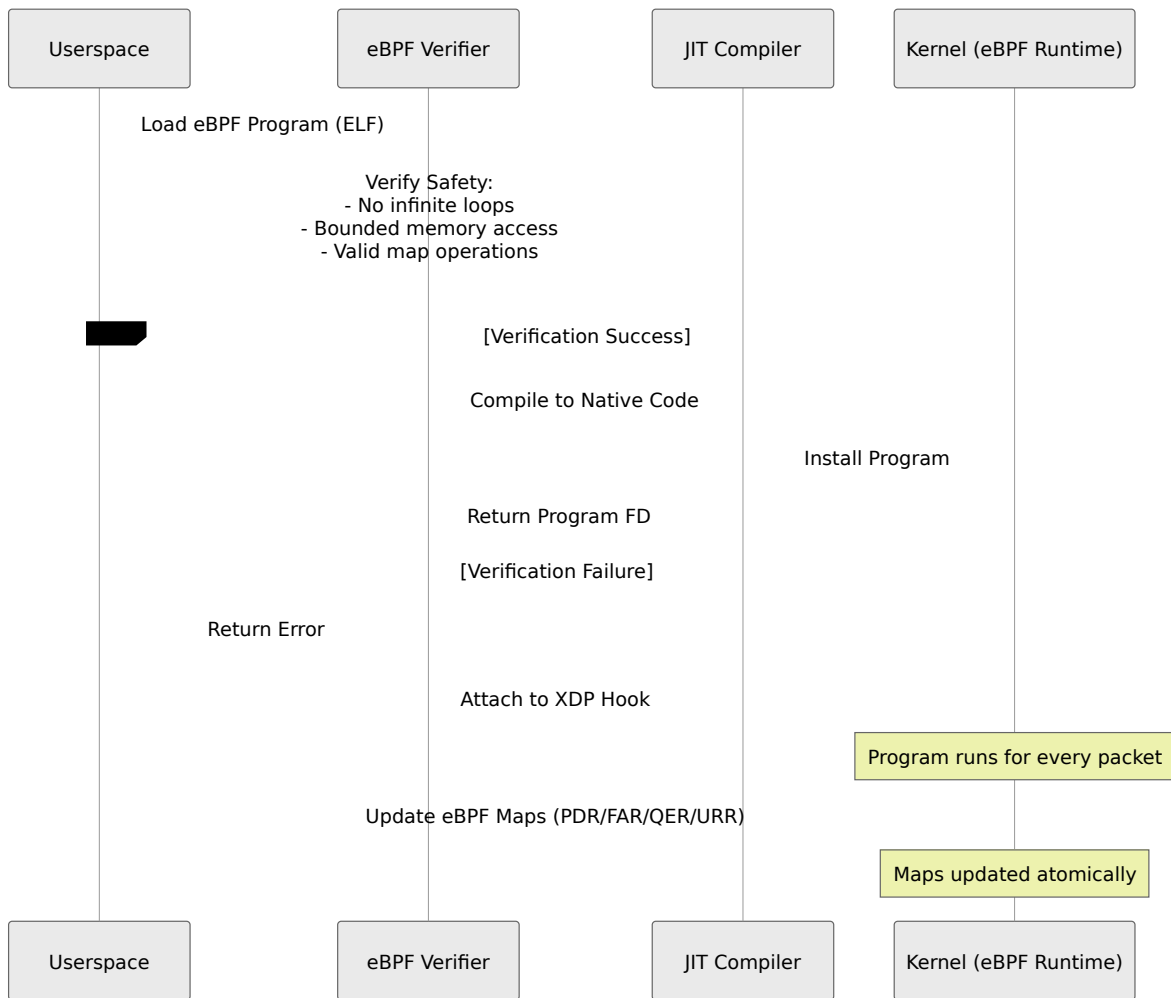

## eBPF Maps

eBPF maps are kernel data structures shared between eBPF programs and userspace.

### Map Types Used in OmniUPF:

Map Type	Description	Use Case
<code>BPF_MAP_TYPE_HASH</code>	Hash table with key-value pairs	PDR lookup by TEID or UE IP
<code>BPF_MAP_TYPE_ARRAY</code>	Array indexed by integer	QER, FAR, URR lookup by ID
<code>BPF_MAP_TYPE_PERCPU_HASH</code>	Per-CPU hash table (lock-free)	High-performance PDR lookups
<code>BPF_MAP_TYPE_LRU_HASH</code>	LRU (Least Recently Used) hash	Automatic eviction of old entries

### Map Operations:

- **Lookup:** O(1) hash lookup (sub-microsecond)
- **Update:** Atomic updates from userspace
- **Delete:** Immediate removal of entries
- **Iterate:** Batch operations for map dumps

## XDP Datapath

### XDP Overview

XDP (eXpress Data Path) is a Linux kernel hook that allows eBPF programs to process packets at the earliest possible point—right after the network driver receives them, before the kernel networking stack.

### XDP Attach Modes

OmniUPF supports three XDP attach modes, each with different performance and compatibility characteristics.

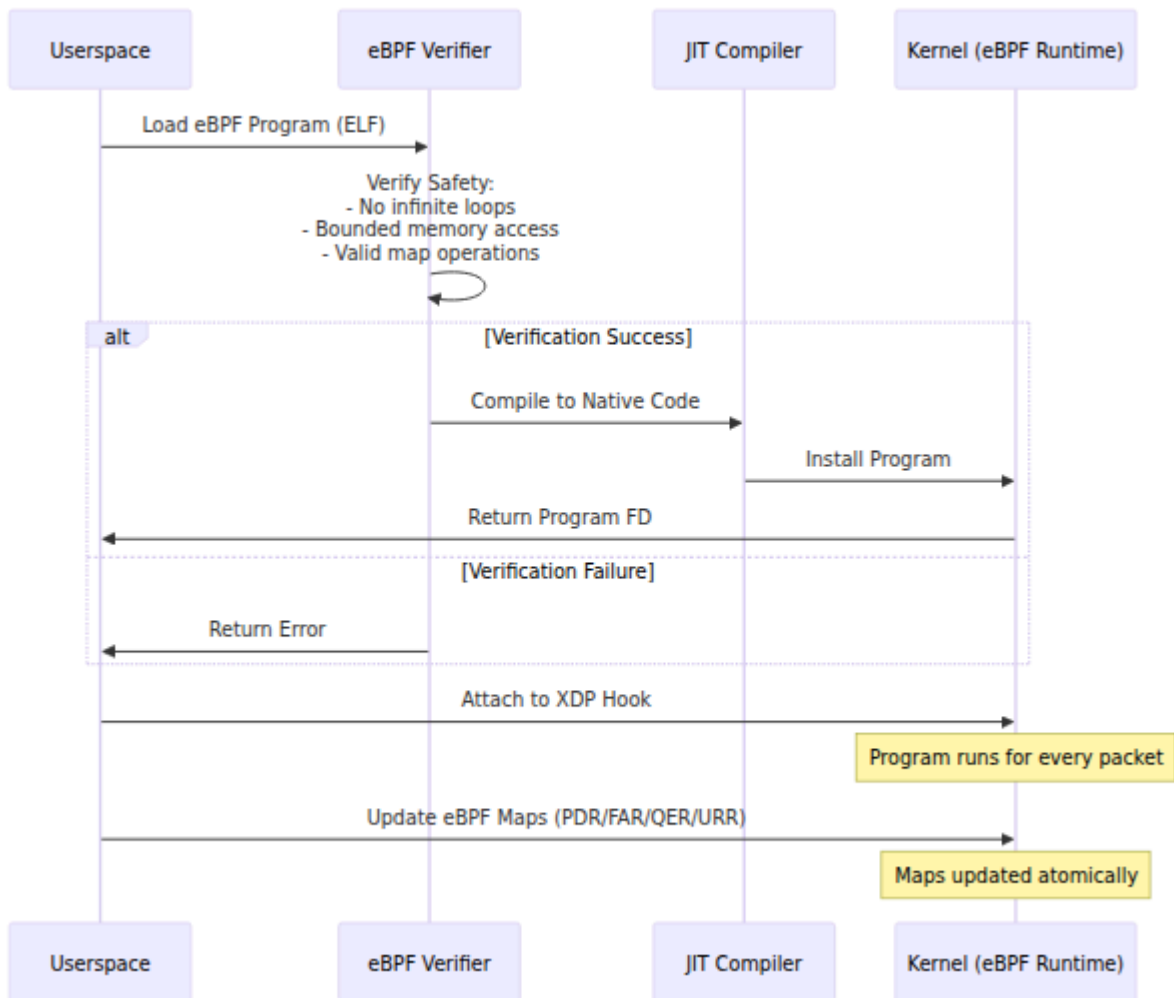

## 1. XDP Offload Mode

### Hardware Execution (Best Performance):

- eBPF program runs directly on SmartNIC hardware
- Packet processing in NIC without touching CPU
- Achieves 100 Gbps+ throughput
- Requires compatible SmartNIC (Netronome, Mellanox ConnectX-6)

### Configuration:

```
xdp_attach_mode: offload
```

### Limitations:

- Requires expensive SmartNIC hardware

- Limited eBPF program complexity
  - Not all eBPF features supported in hardware
- 

## 2. XDP Native Mode (Default for Production)

### Driver-Level Execution (High Performance):

- eBPF program runs in network driver context
- Packets processed before SKB (socket buffer) allocation
- Achieves 10-40 Gbps per core
- Requires driver with XDP support (most modern drivers)

### Configuration:

```
xdp_attach_mode: native
```

### Advantages:

- Very high performance (multi-million pps)
- Wide hardware compatibility
- Full eBPF feature set

### Supported Drivers:

- Intel: i40e, ice, ixgbe, igb
  - Mellanox: mlx4, mlx5
  - Broadcom: bnxt
  - Amazon: ena
  - Most 10G+ network cards
- 

## 3. XDP Generic Mode

### Software Emulation (Compatibility):

- eBPF program runs after kernel allocates SKB

- Software emulation of XDP behavior
- Works on any network interface
- Useful for testing and development

### **Configuration:**

```
xdp_attach_mode: generic
```

### **Use Cases:**

- Development and testing
- Virtualized environments (VMs without SR-IOV)
- Older network hardware
- Loopback interface testing

**Performance:** 1-5 Gbps (significantly slower than native/offload)

---

## **XDP Return Codes**

eBPF programs return XDP action codes to tell the kernel what to do with packets:

Return Code	Meaning	Use in OmniUPF
XDP_PASS	Send packet to kernel network stack	Buffering (local delivery), ICMP, unknown traffic
XDP_DROP	Drop packet immediately	Invalid packets, rate limiting, policy drops
XDP_TX	Transmit packet back out same interface	Not currently used
XDP_REDIRECT	Send packet to different interface	Main forwarding path (N3 ↔ N6)
XDP_ABORTED	Processing error, drop packet and log	eBPF program errors

# Packet Processing Pipeline

## Program Structure

OmniUPF uses eBPF tail calls to create a modular packet processing pipeline.



### Tail Calls:

- Allow eBPF programs to call other eBPF programs
- Reuses same stack frame (bounded stack depth)
- Enables modular pipeline design
- Maximum 33 tail call depth

# Uplink Packet Processing



# Downlink Packet Processing



# eBPF Map Architecture

## Map Memory Layout

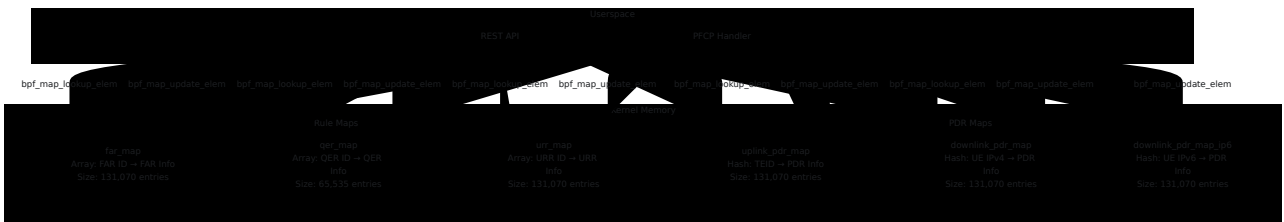

# Map Sizing

OmniUPF automatically calculates map sizes based on `max_sessions` configuration:

```
PDR Maps = 2 × max_sessions (uplink + downlink)
FAR Maps = 2 × max_sessions (uplink + downlink)
QER Maps = 1 × max_sessions (shared per session)
URR Maps = 3 × max_sessions (multiple URRs per session)
```

**Example** (`max_sessions = 65,535`):

- PDR maps: 131,070 entries each
- FAR map: 131,070 entries
- QER map: 65,535 entries
- URR map: 131,070 entries

**Total Memory:**

```
PDR maps: 3 × 131,070 × 212 B = ~83 MB
FAR map: 131,070 × 20 B = ~2.6 MB
QER map: 65,535 × 36 B = ~2.3 MB
URR map: 131,070 × 20 B = ~2.6 MB
Total: ~91 MB kernel memory
```

# Buffering Mechanism

## Buffering Overview

OmniUPF implements packet buffering for handover scenarios by encapsulating packets in GTP-U and sending them to a userspace process via UDP socket.

# Buffering Architecture

Parse error on line 4: .../>2. Add UDP Header (port 22152)<br/>3. -----  
-----^ Expecting 'SQE', 'DOUBLECIRCLEEND', 'PE', '-)', 'STADIUMEND',  
'SUBROUTINEEND', 'PIPE', 'CYLINDEREND', 'DIAMOND\_STOP', 'TAGEND',  
'TRAPEND', 'INVTRAPEND', 'UNICODE\_TEXT', 'TEXT', 'TAGSTART', got 'PS'

Try again

## Buffer Encapsulation Details

When buffering is enabled (FAR action bit 2 set), the eBPF program:

### 1. Calculates Original Packet Size:

```
orig_packet_len = ntohs(ip->tot_len); // From IP header
```

### 2. Expands Packet Header:

```
// Add space for: Outer IP + UDP + GTP-U
gtp_encap_size = sizeof(struct iphdr) + sizeof(struct udphdr) +
sizeof(struct gtpuhdr);
bpf_xdp_adjust_head(ctx, -gtp_encap_size);
```

### 3. Builds Outer IP Header:

```
ip->saddr = original_sender_ip; // Preserve source to avoid
martian filtering
ip->daddr = local_upf_ip; // Local IP where userspace
listener binds
ip->protocol = IPPROTO_UDP;
ip->ttl = 64;
```

### 4. Builds UDP Header:

```
udp->source = htons(22152); // BUFFER_UDP_PORT
udp->dest = htons(22152);
udp->len = htons(sizeof(udphdr) + sizeof(gtpuhdr) +
orig_packet_len);
```

## 5. Builds GTP-U Header:

```
gtp->version = 1;
gtp->message_type = GTPU_G_PDU;
gtp->teid = htonl(far_id | (direction << 24)); // Encode FAR
ID and direction
gtp->message_length = htons(orig_packet_len);
```

## 6. Returns XDP\_PASS:

- Kernel delivers packet to local UDP socket on port 22152
- Userspace buffer manager receives and stores packet

# Buffer Flush Operation

When handover completes, SMF updates FAR to clear BUFFER flag. Buffered packets are replayed:

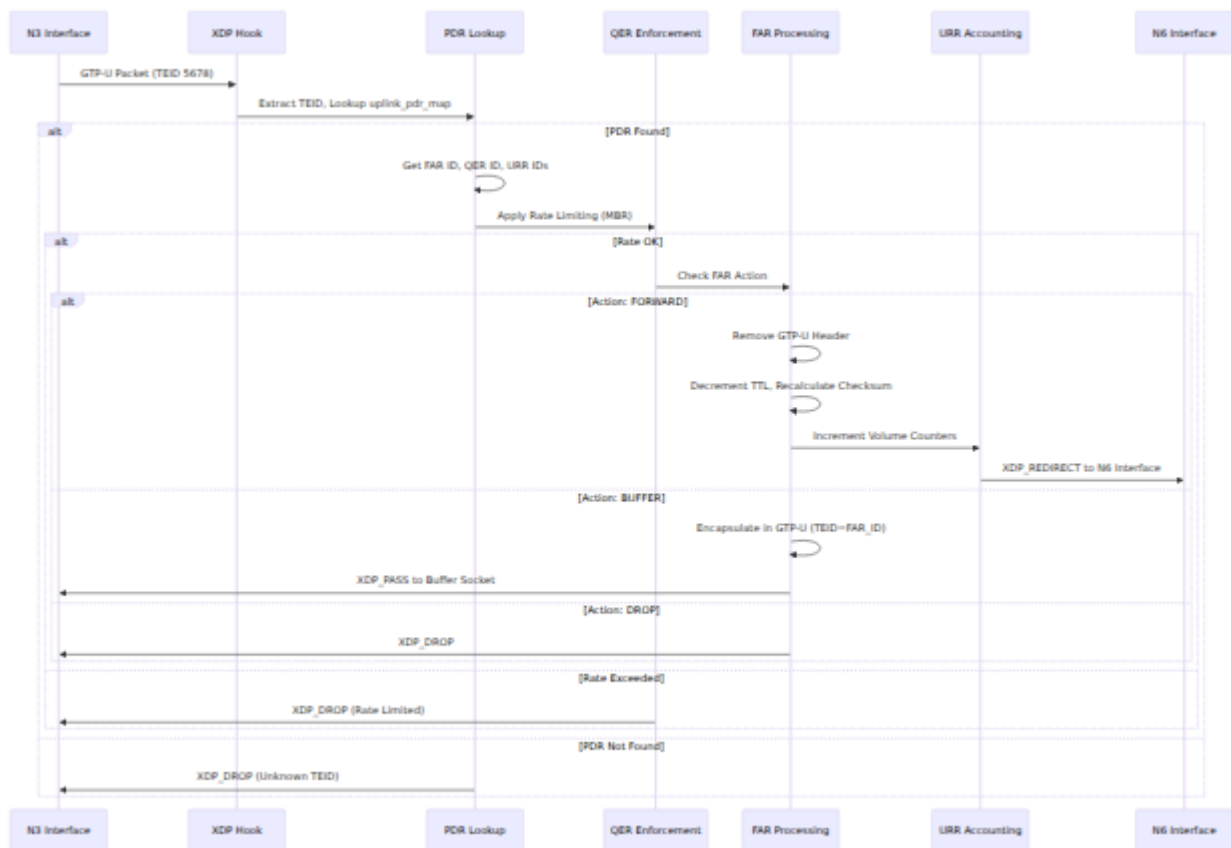

## Buffer Management Parameters

Parameter	Default	Description
<b>Max Per FAR</b>	10,000 packets	Maximum packets buffered per FAR
<b>Max Total</b>	100,000 packets	Maximum total buffered packets
<b>Packet TTL</b>	30 seconds	Time before buffered packets expire
<b>Buffer Port</b>	22152	UDP port for buffer delivery
<b>Buffer Cleanup Interval</b>	60 seconds	How often to check for expired packets

# QoS Enforcement

## Rate Limiting Algorithm

OmniUPF implements a **sliding window rate limiter** for QoS enforcement.

```
Parse error on line 5: ...= packet_size × 8 × (NSEC_PER_SEC / rate -----
-----^ Expecting 'SQE', 'DOUBLECIRCLEEND', 'PE', '-)', 'STADIUMEND',
'SUBROUTINEEND', 'PIPE', 'CYLINDEREND', 'DIAMOND_STOP', 'TAGEND',
'TRAPEND', 'INVTRAPEND', 'UNICODE_TEXT', 'TEXT', 'TAGSTART', got 'PS'
```

Try again

## Sliding Window Implementation

**Algorithm** (from `qer.h`):

```

static __always_inline enum xdp_action limit_rate_sliding_window(
 const __u64 packet_size,
 volatile __u64 *window_start,
 const __u64 rate)
{
 static const __u64 NSEC_PER_SEC = 1000000000ULL;
 static const __u64 window_size = 5000000ULL; // 5ms window

 // Rate = 0 means unlimited
 if (rate == 0)
 return XDP_PASS;

 // Calculate transmission time for this packet
 __u64 tx_time = packet_size * 8 * (NSEC_PER_SEC / rate);
 __u64 now = bpf_ktime_get_ns();

 // Check if we're ahead of window (packet would transmit in
 the future)
 __u64 start = *window_start;
 if (start + tx_time > now)
 return XDP_DROP; // Rate limit exceeded

 // If window has passed, reset it
 if (start + window_size < now) {
 *window_start = now - window_size + tx_time;
 return XDP_PASS;
 }

 // Update window to account for this packet
 *window_start = start + tx_time;
 return XDP_PASS;
}

```

### Key Parameters:

- **Window Size:** 5ms (5,000,000 nanoseconds)
- **Per-Direction:** Separate windows for uplink and downlink
- **Atomic Updates:** Uses volatile pointers for concurrent access
- **MBR = 0:** Treated as unlimited bandwidth

# QoS Example Calculation

**Scenario:** MBR = 100 Mbps, Packet Size = 1500 bytes

## 1. Transmission Time:

$$\begin{aligned} \text{tx\_time} &= 1500 \text{ bytes} \times 8 \text{ bits/byte} \times (1,000,000,000 \text{ ns/sec} \div \\ &100,000,000 \text{ bps}) \\ \text{tx\_time} &= 1500 \times 8 \times 10 = 120,000 \text{ ns} = 120 \mu\text{s} \end{aligned}$$

## 2. Rate Check:

- If last packet transmitted at  $t=0$ , next packet can transmit at  $t=120\mu\text{s}$
- If packet arrives at  $t=100\mu\text{s}$ , it's dropped (too early)
- If packet arrives at  $t=150\mu\text{s}$ , it's forwarded (window advanced)

## 3. Maximum Packet Rate:

$$\begin{aligned} \text{Max PPS} &= (100 \text{ Mbps} \div 8) \div 1500 \text{ bytes} = 8,333 \text{ packets/second} \\ \text{Inter-packet gap} &= 120 \mu\text{s} \end{aligned}$$

# Performance Characteristics

## Throughput

Configuration	Throughput	Packets/Second	Latency
<b>XDP Offload</b> (SmartNIC)	100 Gbps	148 Mpps	< 1 $\mu$ s
<b>XDP Native</b> (10G NIC, single core)	10 Gbps	8 Mpps	2-5 $\mu$ s
<b>XDP Native</b> (10G NIC, 4 cores)	40 Gbps	32 Mpps	2-5 $\mu$ s
<b>XDP Generic</b>	1-5 Gbps	0.8-4 Mpps	50-100 $\mu$ s

## Latency Breakdown

**Total Packet Processing Latency** (XDP Native):

Stage	Latency	Cumulative
NIC RX	0.5 $\mu$ s	0.5 $\mu$ s
XDP Hook Invocation	0.1 $\mu$ s	0.6 $\mu$ s
PDR Lookup (Hash)	0.3 $\mu$ s	0.9 $\mu$ s
QER Rate Check	0.1 $\mu$ s	1.0 $\mu$ s
FAR Processing	0.5 $\mu$ s	1.5 $\mu$ s
URR Update	0.2 $\mu$ s	1.7 $\mu$ s
GTP-U Encap/Decap	0.8 $\mu$ s	2.5 $\mu$ s
XDP_REDIRECT	0.5 $\mu$ s	3.0 $\mu$ s
NIC TX	0.5 $\mu$ s	3.5 $\mu$ s

**Total:** ~3.5  $\mu$ s per packet (XDP Native, 10G NIC)

## CPU Utilization

### Per-Core Processing Capacity:

- Single core: 8-10 Mpps (XDP Native)
- With hyper-threading: 12-15 Mpps
- Multi-core scaling: Near-linear up to 8 cores

### CPU Usage by Packet Rate:

$$\text{CPU \%} \approx (\text{Packet Rate} / 10,000,000) \times 100\% \text{ per core}$$

**Example:** 2 Mpps traffic uses ~20% of one core

# Memory Bandwidth

## eBPF Map Access:

- Hash lookup: ~100 ns (cache hit)
- Hash lookup: ~300 ns (cache miss)
- Array lookup: ~50 ns (always cache hit)

## Memory Bandwidth Required:

```
Bandwidth = Packet Rate × (Avg Packet Size + Map Lookups × 64 bytes)
```

**Example:** 10 Mpps × (1500 B + 3 lookups × 64 B) ≈ 160 Gbps memory bandwidth

# Scalability and Tuning

## Horizontal Scaling

### Multiple UPF Instances:

Setting SMF as parent of SMF would create a cycle

Try again

### Session Distribution:

- SMF distributes sessions across UPF instances
- Each UPF handles subset of UE sessions
- No inter-UPF communication needed (stateless)

## Vertical Scaling

### CPU Tuning:

1. Enable CPU affinity for XDP processing

2. Use RSS (Receive Side Scaling) to distribute RX queues
3. Pin eBPF programs to specific cores

### **NIC Tuning:**

1. Increase RX ring buffer size
2. Enable multi-queue NICs (RSS)
3. Use flow director for traffic steering

### **Kernel Tuning:**

```
Increase locked memory limit for eBPF maps
ulimit -l unlimited

Disable IRQ balance for XDP cores
systemctl stop irqbalance

Set CPU governor to performance
cpupower frequency-set -g performance

Increase network buffer sizes
sysctl -w net.core.rmem_max=134217728
sysctl -w net.core.wmem_max=134217728
```

## **Capacity Planning**

### **Formula:**

```
Required CPU Cores = (Expected PPS ÷ 10,000,000) × 1.5 (50%
headroom)
Required Memory = (Max Sessions × 212 B × 3) + 100 MB (eBPF maps +
overhead)
Required Network = (Peak Throughput × 2) + 10 Gbps (headroom)
```

### **Example** (1 million sessions, 20 Gbps peak):

- CPU:  $(20 \text{ Gbps} \div 10 \text{ Gbps per core}) \times 1.5 = 3\text{-}4$  cores
- Memory:  $(1\text{M} \times 212 \text{ B} \times 3) + 100 \text{ MB} \approx 750 \text{ MB}$

- Network:  $(20 \text{ Gbps} \times 2) + 10 \text{ Gbps} = 50 \text{ Gbps}$  interfaces

## Related Documentation

- **UPF Operations Guide** - General UPF operations and deployment
- **Rules Management Guide** - PDR, FAR, QER, URR details
- **Monitoring Guide** - Performance monitoring and metrics
- **Web UI Operations Guide** - Control panel usage
- **Troubleshooting Guide** - Common issues and diagnostics

# OmniUPF Configuration Guide

## Table of Contents

1. [Overview](#)
  2. [Operating Modes](#)
  3. [XDP Attachment Modes](#)
  4. [Configuration Parameters](#)
  5. [Configuration Methods](#)
  6. [Hypervisor Compatibility](#)
  7. [NIC Compatibility](#)
  8. [Configuration Examples](#)
  9. [Map Sizing and Capacity Planning](#)
- 

## Overview

OmniUPF is a versatile user plane function that can operate in multiple modes to support both 4G (EPC) and 5G core networks. Configuration is managed through YAML configuration files.

---

## Operating Modes

OmniUPF is a **unified platform** that can simultaneously operate as:

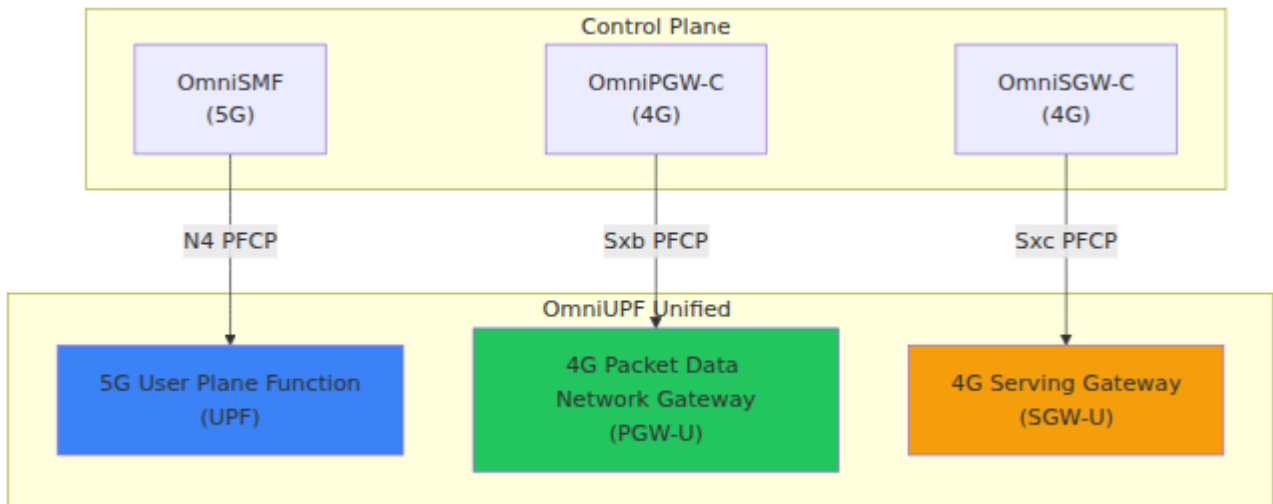

## Mode Configuration

The operating mode is **determined by the control plane** (SMF, PGW-C, or SGW-C) that establishes PFCP associations with OmniUPF. No specific OmniUPF configuration is required to switch between modes.

### Simultaneous Operation:

- OmniUPF can accept PFCP associations from multiple control planes concurrently
- A single OmniUPF instance can act as UPF, PGW-U, and SGW-U **at the same time**
- Sessions from different control planes are isolated and managed independently

## XDP Attachment Modes

OmniUPF uses XDP (eXpress Data Path) for high-performance packet processing. Three attachment modes are supported.

**For detailed XDP setup instructions, especially for Proxmox and other hypervisors, see the [XDP Modes Guide](#).**

# Mode Comparison

<b>Mode</b>	<b>Attach Point</b>	<b>Performance</b>	<b>Use Case</b>	<b>NIC Requirements</b>
<b>Generic</b>	Network stack (kernel)	~1-2 Mpps	Testing, development, compatibility	Any NIC
<b>Native</b>	Network driver (kernel)	~5-10 Mpps	Production (bare metal, VM with SR-IOV)	XDP-capable driver
<b>Offload</b>	NIC hardware (SmartNIC)	~10-40 Mpps	High-throughput production	SmartNIC with XDP offload

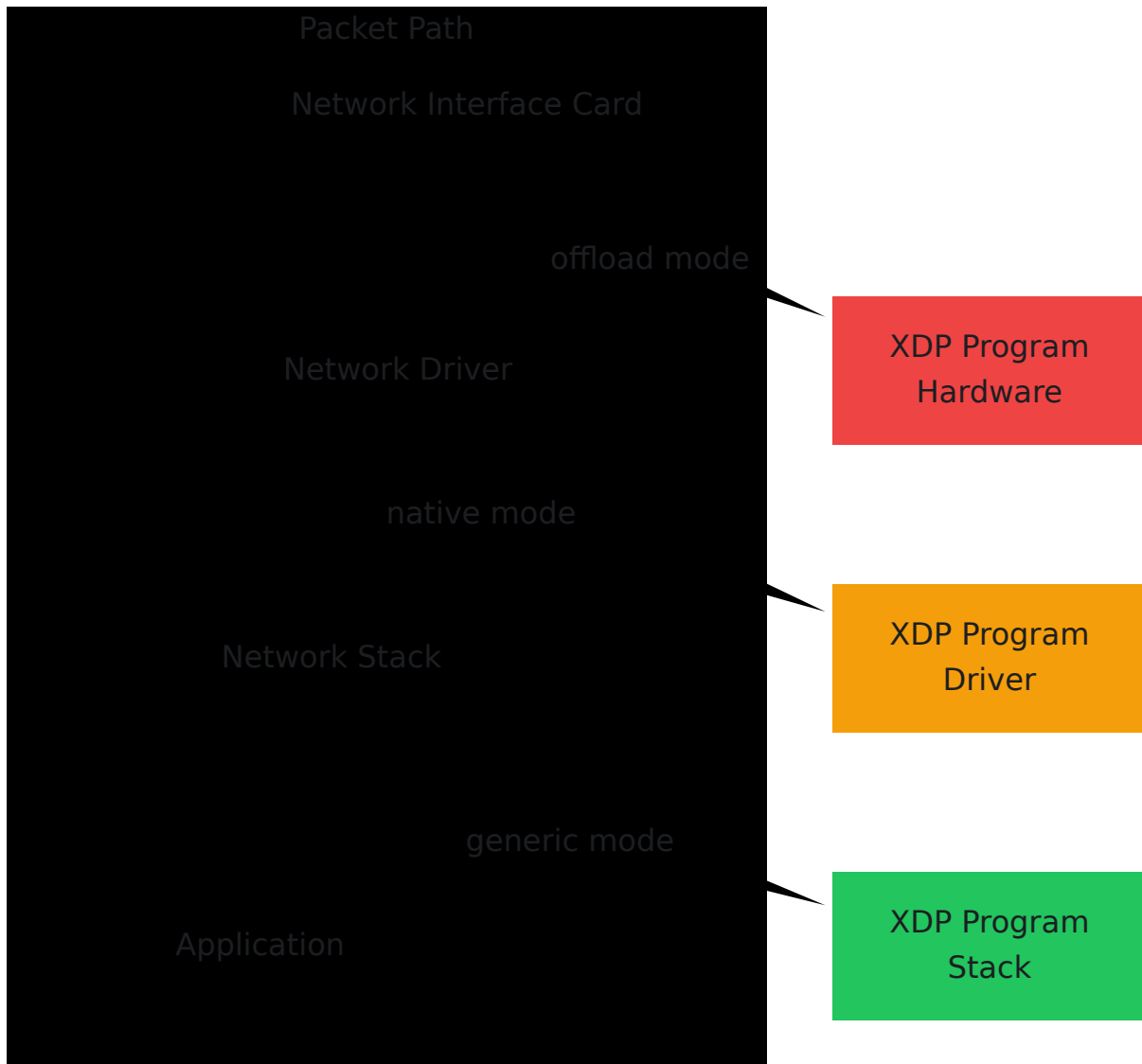

## Generic Mode (Default)

**Description:** XDP program runs in the kernel network stack

### Advantages:

- Works with **any** network interface
- No special driver or hardware requirements
- Ideal for testing and development
- Compatible with all hypervisors and virtualization platforms

### Disadvantages:

- Lower performance (~1-2 Mpps per core)

- Packets already passed through driver before XDP processing

### **Configuration:**

```
xdp_attach_mode: generic
```

### **Best for:**

- Virtual machines without SR-IOV
  - Testing and validation environments
  - NICs without XDP driver support
  - Hypervisors like Proxmox, VMware, VirtualBox
- 

## **Native Mode (Recommended)**

**Description:** XDP program runs at the network driver level

### **Advantages:**

- High performance (~5-10 Mpps per core)
- Packets processed before entering network stack
- Significantly lower latency than generic mode
- Works on bare metal and SR-IOV VMs

### **Disadvantages:**

- Requires network driver with XDP support
- Not all NICs/drivers support native XDP

### **Configuration:**

```
xdp_attach_mode: native
```

### **Best for:**

- Production deployments on bare metal

- VMs with SR-IOV passthrough
- NICs with XDP-capable drivers (Intel, Mellanox, etc.)

**Requirements:**

- XDP-capable network driver (see [NIC Compatibility](#))
  - Linux kernel 5.15+ with XDP support enabled
- 

## Offload Mode (Maximum Performance)

**Description:** XDP program runs directly on SmartNIC hardware

**Advantages:**

- Maximum performance (~10-40 Mpps)
- Zero CPU overhead for packet processing
- Sub-microsecond latency
- Frees CPU for control plane processing

**Disadvantages:**

- Requires expensive SmartNIC hardware
- Limited SmartNIC availability
- Complex setup and configuration

**Configuration:**

```
xdp_attach_mode: offload
```

**Best for:**

- Ultra-high-throughput production deployments
- Edge computing with strict latency requirements
- Environments where CPU resources are limited

**Requirements:**

- SmartNIC with XDP offload support (Netronome Agilio CX, Mellanox BlueField)
- Specialized firmware and drivers

---

# Configuration Parameters

## Network Interfaces

Parameter	Description	Type	Default
<code>interface_name</code>	Network interfaces for N3/N6/N9 traffic (XDP attachment points)	List	<code>[lo]</code>
<code>n3_address</code>	IPv4 address for N3 interface (GTP-U from RAN)	IP	<code>127.0.0.1</code>
<code>n9_address</code>	IPv4 address for N9 interface (UPF-to-UPF for ULCL)	IP	Same as <code>n3_address</code>

### Example:

```
interface_name: [eth0, eth1]
n3_address: 10.100.50.233
n9_address: 10.100.50.234
```

---

# PFCP Configuration

Parameter	Description	Type	Default
<code>pfcp_address</code>	Local address for PFCP server (N4/Sxb/Sxc interface)	Host:Port	<code>:8805</code>
<code>pfcp_node_id</code>	Local Node ID for PFCP protocol	IP	<code>127.0.0.1</code>
<code>pfcp_remote_node</code>	Remote PFCP peers (SMF/PGW-C/SGW-C) to connect	List	<code>[]</code>
<code>association_setup_timeout</code>	Timeout between Association Setup Requests (seconds)	Integer	<code>5</code>
<code>heartbeat_retries</code>	Number of heartbeat retries before declaring peer dead	Integer	<code>3</code>
<code>heartbeat_interval</code>	PFCP heartbeat interval (seconds)	Integer	<code>5</code>
<code>heartbeat_timeout</code>	PFCP heartbeat timeout (seconds)	Integer	<code>5</code>

## Example:

```
pfcp_address: :8805
pfcp_node_id: 10.100.50.241
pfcp_remote_node:
 - 10.100.50.10 # OmniSMF
 - 10.100.60.20 # OmniPGW-C
heartbeat_interval: 10
heartbeat_retries: 5
```

---

## API and Monitoring

Parameter	Description	Type	Default
<code>api_address</code>	Local address for REST API server	Host:Port	<code>:8080</code>
<code>metrics_address</code>	Local address for Prometheus metrics endpoint (see <a href="#">Metrics Reference</a> )	Host:Port	<code>:9090</code>
<code>logging_level</code>	Logging level ( <code>trace</code> , <code>debug</code> , <code>info</code> , <code>warn</code> , <code>error</code> )	String	<code>info</code>

### Example:

```
api_address: :8080
metrics_address: :9090
logging_level: debug
```

---

# GTP Path Management

Parameter	Description	Type	Default
<code>gtp_peer</code>	List of GTP peers for Echo Request keepalives	List	<code>[]</code>
<code>gtp_echo_interval</code>	Interval between GTP Echo Requests (seconds)	Integer	<code>10</code>

## Example:

```
gtp_peer:
- 10.100.50.50:2152 # gNB
- 10.100.50.60:2152 # Another UPF for N9
gtp_echo_interval: 15
```

---

# eBPF Map Capacity

Parameter	Description	Type	Default	Auto-calculated
<code>max_sessions</code>	Maximum number of concurrent sessions	Integer	<code>65535</code>	Used to calculate map sizes
<code>pdr_map_size</code>	Size of PDR eBPF map	Integer	<code>0</code>	$\text{max\_sessions} \times 2$
<code>far_map_size</code>	Size of FAR eBPF map	Integer	<code>0</code>	$\text{max\_sessions} \times 2$
<code>qer_map_size</code>	Size of QER eBPF map	Integer	<code>0</code>	<code>max_sessions</code>
<code>urr_map_size</code>	Size of URR eBPF map	Integer	<code>0</code>	$\text{max\_sessions} \times 2$

**Note:** Setting map sizes to `0` (default) enables auto-calculation based on `max_sessions`. Override with specific values if custom sizing is needed.

## Example:

```
max_sessions: 100000
Maps will be auto-sized:
PDR: 200,000 entries
FAR: 200,000 entries
QER: 100,000 entries
URR: 200,000 entries
```

## Custom sizing example:

```
max_sessions: 50000
pdr_map_size: 131070 # Custom size
far_map_size: 131070
qer_map_size: 65535
urr_map_size: 131070
```

## Buffer Configuration

Parameter	Description	Type	Default
<code>buffer_port</code>	UDP port for buffered packets from eBPF	Integer	<code>22152</code>
<code>buffer_max_packets</code>	Maximum packets to buffer per FAR	Integer	<code>10000</code>
<code>buffer_max_total</code>	Maximum total buffered packets (0=unlimited)	Integer	<code>100000</code>
<code>buffer_packet_ttl</code>	TTL for buffered packets in seconds (0=no expiration)	Integer	<code>30</code>
<code>buffer_cleanup_interval</code>	Buffer cleanup interval in seconds (0=no cleanup)	Integer	<code>60</code>

### Example:

```
buffer_port: 22152
buffer_max_packets: 20000
buffer_max_total: 200000
buffer_packet_ttl: 60
buffer_cleanup_interval: 30
```

## Feature Flags

Parameter	Description	Type	Default
<code>feature_ueip</code>	Enable UE IP allocation by OmniUPF	Boolean	<code>false</code>
<code>ueip_pool</code>	IP pool for UE IP allocation (requires <code>feature_ueip</code> )	CIDR	<code>10.60.0.0/24</code>
<code>feature_ftup</code>	Enable F-TEID allocation by OmniUPF	Boolean	<code>false</code>
<code>teid_pool</code>	TEID pool size for F-TEID allocation (requires <code>feature_ftup</code> )	Integer	<code>65535</code>

### Example (UE IP allocation):

```
feature_ueip: true
ueip_pool: 10.45.0.0/16 # Allocate UE IPs from this pool
```

### Example (F-TEID allocation):

```
feature_ftup: true
teid_pool: 1000000 # Allow up to 1M TEID allocations
```

---

## Route Manager Configuration

For UE route synchronization with FRR (Free Range Routing) daemon. See [Route Management Guide](#) for details.

Parameter	Description	Type	Default
<code>route_manager_enabled</code>	Enable automatic UE route synchronization	Boolean	<code>false</code>
<code>route_manager_type</code>	Routing daemon type ( <code>frr</code> supported)	String	<code>frr</code>
<code>route_manager_vtysh_path</code>	Path to vtysh command	String	<code>/usr/bin/vtysh</code>
<code>route_manager_nexthop</code>	Next-hop IP for UE routes	IP Address	<code>``</code> (empty)

### Example:

```
route_manager_enabled: true
route_manager_type: frr
route_manager_vtysh_path: /usr/bin/vtysh
route_manager_nexthop: 10.0.1.1 # Next hop for UE routes
```

### When to Enable:

- Multi-UPF deployments requiring route advertisement
  - Integration with OSPF or BGP routing protocols
  - Requires FRRouting daemon installed and configured
-

# Configuration Methods

## YAML Configuration File (Recommended)

File: `config.yml`

```
Network Configuration
interface_name: [eth0]
n3_address: 10.100.50.233
n9_address: 10.100.50.233
xdp_attach_mode: native

PFCP Configuration
pfcf_address: :8805
pfcf_node_id: 10.100.50.241
pfcf_remote_node:
 - 10.100.50.10

API and Monitoring
api_address: :8080
metrics_address: :9090
logging_level: info

Capacity
max_sessions: 100000

GTP Peers
gtp_peer:
 - 10.100.50.50:2152
gtp_echo_interval: 10

Features
feature_ueip: true
ueip_pool: 10.45.0.0/16
feature_ftup: false

Buffering
buffer_max_packets: 15000
buffer_packet_ttl: 45
```

---

# Hypervisor Compatibility

## Overview

OmniUPF is compatible with all major hypervisors and virtualization platforms. The XDP attach mode and network configuration depend on the hypervisor's networking capabilities.

**For step-by-step instructions on enabling native XDP on Proxmox and other hypervisors, see the [XDP Modes Guide](#).**

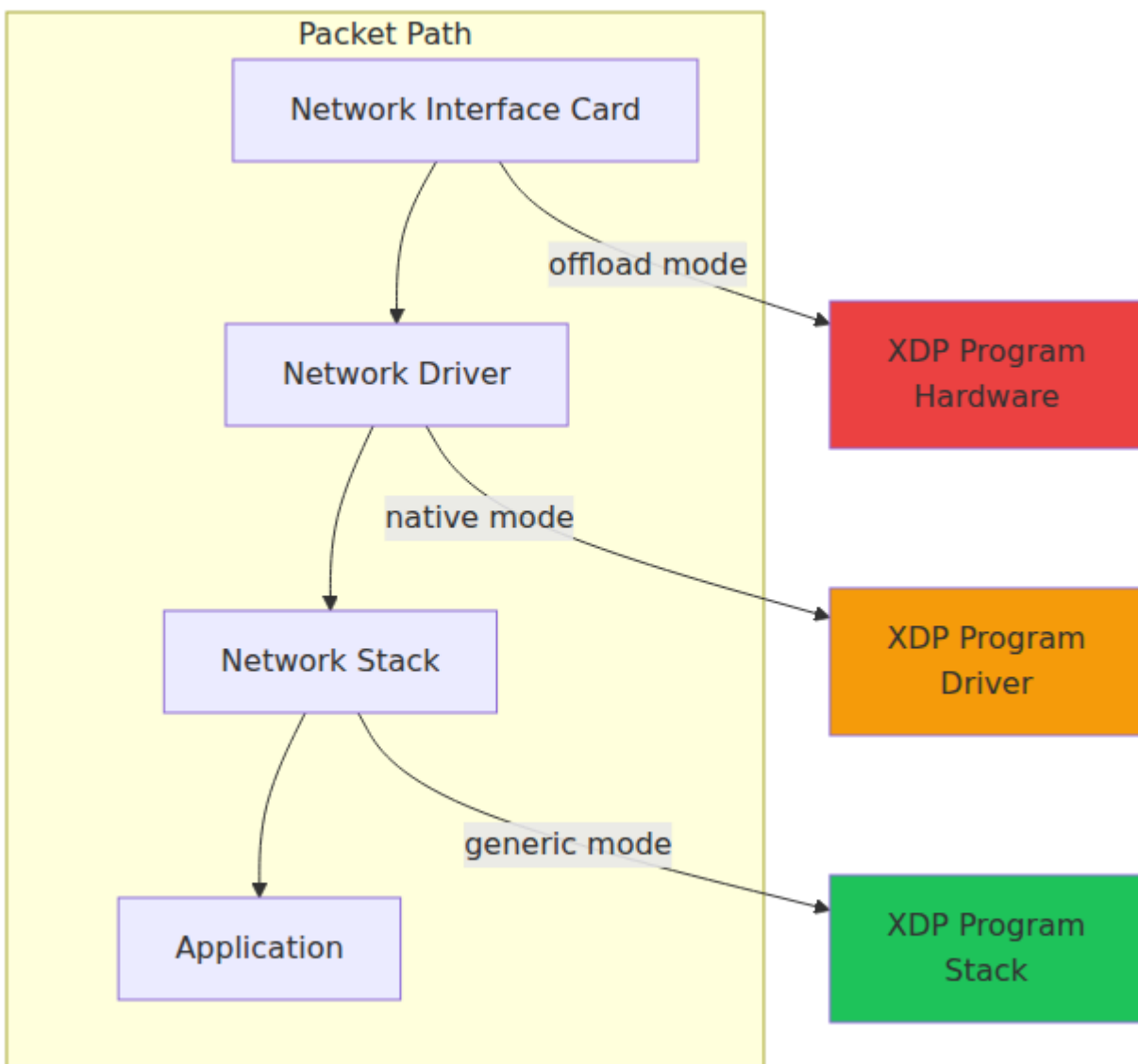

# Proxmox VE

## Supported Configurations:

### 1. Bridge Mode (Generic XDP)

**Use case:** Standard VM networking

#### Configuration:

- Network Device: VirtIO or E1000
- XDP Mode: `generic`
- Performance: ~1-2 Mpps

#### Proxmox VM Settings:

```
Network Device: net0
Model: VirtIO (paravirtualized)
Bridge: vbr0
```

#### OmniUPF Config:

```
interface_name: [eth0]
xdp_attach_mode: generic
```

---

### 2. SR-IOV Passthrough (Native XDP)

**Use case:** High-performance production

#### Configuration:

- Network Device: SR-IOV Virtual Function
- XDP Mode: `native`
- Performance: ~5-10 Mpps

#### Requirements:

- Physical NIC with SR-IOV support (Intel X710, Mellanox ConnectX-5)
- SR-IOV enabled in BIOS
- IOMMU enabled (`intel_iommu=on` or `amd_iommu=on` in GRUB)

### Enable SR-IOV on Proxmox:

```
Edit GRUB configuration
nano /etc/default/grub

Add to GRUB_CMDLINE_LINUX_DEFAULT:
intel_iommu=on iommu=pt

Update GRUB and reboot
update-grub
reboot

Enable VFs on NIC (example: 4 virtual functions on eth0)
echo 4 > /sys/class/net/eth0/device/sriov_numvfs

Make persistent
echo "echo 4 > /sys/class/net/eth0/device/sriov_numvfs" >>
/etc/rc.local
chmod +x /etc/rc.local
```

### Proxmox VM Settings:

```
Hardware → Add → PCI Device
Select: SR-IOV Virtual Function
All Functions: No
Primary GPU: No
PCI-Express: Yes (optional)
```

### OmniUPF Config:

```
interface_name: [ens1f0] # SR-IOV VF name
xdp_attach_mode: native
```

---

### 3. PCI Passthrough (Native XDP)

**Use case:** Dedicated NIC for single VM

#### Configuration:

- Entire physical NIC passed to VM
- XDP Mode: `native` or `offload` (if SmartNIC)
- Performance: ~5-40 Mpps (depends on NIC)

#### Proxmox VM Settings:

```
Hardware → Add → PCI Device
Select: Physical NIC (e.g., 0000:01:00.0)
All Functions: Yes
Primary GPU: No
PCI-Express: Yes
```

#### OmniUPF Config:

```
interface_name: [ens1f0]
xdp_attach_mode: native # or 'offload' for SmartNIC
```

---

## KVM/QEMU

#### Bridge Mode:

```
virt-install \
 --name omniupf \
 --network bridge=br0,model=virtio \
 --disk path=/var/lib/libvirt/images/omniupf.qcow2 \
 ...
```

#### SR-IOV Passthrough:

```
<interface type='hostdev' managed='yes'>
 <source>
 <address type='pci' domain='0x0000' bus='0x01' slot='0x10'
function='0x1' />
 </source>
</interface>
```

---

## VMware ESXi

### Standard vSwitch (Generic XDP):

- Network Adapter: VMXNET3
- XDP Mode: `generic`

### SR-IOV (Native XDP):

- Enable SR-IOV in ESXi host settings
  - Add SR-IOV network adapter to VM
  - XDP Mode: `native`
- 

## Microsoft Hyper-V

### Virtual Switch (Generic XDP):

- Network Adapter: Synthetic
- XDP Mode: `generic`

### SR-IOV (Native XDP):

- Enable SR-IOV in Hyper-V Manager
  - Configure SR-IOV on virtual network adapter
  - XDP Mode: `native`
-

# VirtualBox

## NAT/Bridged Mode (Generic XDP only):

- Network Adapter: VirtIO-Net or Intel PRO/1000
  - XDP Mode: `generic`
  - Note: VirtualBox does **not** support SR-IOV
- 

# NIC Compatibility

## Understanding Mpps vs Throughput

**Packets per second (Mpps) and throughput (Gbps) are not directly equivalent** - the relationship depends entirely on packet size. Mobile network traffic varies dramatically in packet size, from tiny VoIP packets to large video streaming frames.

### Packet Size Impact on Throughput

In mobile networks, the UPF processes GTP-U encapsulated packets on the N3 interface and native IP packets on the N6 interface.

### GTP-U Encapsulation Overhead (N3 Interface):

- **Outer IPv4 header:** 20 bytes
- **Outer UDP header:** 8 bytes
- **GTP-U header:** 8 bytes
- **Total GTP-U overhead:** 36 bytes

### Minimum GTP-U Packet (N3):

- **Inner IP header:** 20 bytes (IPv4)
- **Inner UDP header:** 8 bytes
- **Minimum payload:** 1 byte
- **Inner packet total:** 29 bytes
- **Plus GTP-U overhead:** 36 bytes

- **Total packet size:** 65 bytes

#### **Throughput at 1 Mpps with minimum GTP-U packets:**

$$65 \text{ bytes} \times 1,000,000 \text{ pps} \times 8 \text{ bits/byte} = 520 \text{ Mbps}$$

#### **Maximum GTP-U Packet (N3 with 1500 MTU):**

- **Inner IP MTU:** 1500 bytes (full inner IP packet)
- **Plus GTP-U overhead:** 36 bytes
- **Total packet size:** 1536 bytes

#### **Throughput at 1 Mpps with maximum GTP-U packets:**

$$1536 \text{ bytes} \times 1,000,000 \text{ pps} \times 8 \text{ bits/byte} = 12,288 \text{ Mbps} \approx 12.3 \text{ Gbps}$$

#### **Native IP Packets (N6 Interface):**

On N6 (towards Internet), packets are native IP without GTP-U:

#### **Minimum N6 packet:**

- **IP header:** 20 bytes
- **UDP header:** 8 bytes
- **Minimum payload:** 1 byte
- **Total:** 29 bytes

#### **Throughput at 1 Mpps with minimum N6 packets:**

$$29 \text{ bytes} \times 1,000,000 \text{ pps} \times 8 \text{ bits/byte} = 232 \text{ Mbps}$$

#### **Maximum N6 packet (1500 MTU):**

- **IP MTU:** 1500 bytes
- **Total:** 1500 bytes

#### **Throughput at 1 Mpps with maximum N6 packets:**

$1500 \text{ bytes} \times 1,000,000 \text{ pps} \times 8 \text{ bits/byte} = 12,000 \text{ Mbps} = 12 \text{ Gbps}$

## Real-World Performance Examples

### Intel X710 NIC (10 Mpps capacity on N3 interface with GTP-U):

Traffic Pattern	Inner Packet Size	GTP-U Total	Throughput at 10 Mpps	Typical Use Case
VoIP calls (N3)	65-150 bytes	101-186 bytes	<b>0.8-1.5 Gbps</b>	AMR-WB voice, G.711
Light web (N3)	400-600 bytes	436-636 bytes	<b>3.5-5.1 Gbps</b>	HTTP/HTTPS, messaging
<b>Modern mobile (N3)</b>	<b>1200 bytes</b>	<b>1236 bytes</b>	<b>9.9 Gbps</b>	<b>Typical 2024 traffic mix</b>
Video streaming (N3)	1400-1450 bytes	1436-1486 bytes	<b>11.5-11.9 Gbps</b>	HD/4K video chunks
Maximum MTU (N3)	1500 bytes	1536 bytes	<b>12.3 Gbps</b>	Large TCP downloads

### On N6 interface (native IP, no GTP-U):

Traffic Pattern	Packet Size	Throughput at 10 Mpps	Typical Use Case
VoIP packets	65-150 bytes	<b>0.5-1.2 Gbps</b>	Voice RTP streams
Light web	400-600 bytes	<b>3.2-4.8 Gbps</b>	HTTP requests
<b>Modern mobile</b>	<b>1200 bytes</b>	<b>9.6 Gbps</b>	<b>Typical 2024 traffic</b>
Video streaming	1400-1450 bytes	<b>11.2-11.6 Gbps</b>	Video downloads
Maximum MTU	1500 bytes	<b>12.0 Gbps</b>	Large file transfers

**At 10 Mpps with modern mobile traffic (1200-byte average), expect ~10 Gbps throughput** on both N3 and N6 interfaces.

### Why This Matters for Mobile Networks:

Mobile traffic is **highly variable** in packet size and the GTP-U overhead (36 bytes) significantly impacts small packet performance:

### Inner packet size (actual user data):

- **VoIP (AMR-WB codec):** 65-80 bytes → With GTP-U: 101-116 bytes
- **IoT sensor data:** 50-200 bytes → With GTP-U: 86-236 bytes
- **Web browsing (HTTP/3):** 400-800 bytes → With GTP-U: 436-836 bytes
- **Video streaming:** 1200-1450 bytes → With GTP-U: 1236-1486 bytes
- **Large downloads:** 1500 bytes → With GTP-U: 1536 bytes

### Impact of GTP-U overhead:

- Small packets (< 200 bytes): ~**35-70% overhead** - Mpps is limiting factor
- Medium packets (200-800 bytes): ~**5-20% overhead** - Mixed limitation

- Large packets (> 1200 bytes): ~**3% overhead** - Link speed is limiting factor

### **Performance Planning:**

A NIC rated at **10 Mpps** will achieve on N3 interface:

- **VoIP-heavy traffic** (100-byte inner packets): ~1.0 Gbps (GTP-U overhead dominates)
- **Modern mobile mix** (1200-byte average inner packets): ~9.9 Gbps
- **Video-heavy traffic** (1400-byte inner packets): ~11.5 Gbps
- **Maximum throughput** (1500-byte inner packets): ~12.3 Gbps

**On N6 interface** (no GTP-U overhead):

- **Modern mobile mix** (1200-byte packets): ~9.6 Gbps at 10 Mpps
- **Maximum throughput** (1500-byte packets): ~12.0 Gbps at 10 Mpps

### **Rule of Thumb for Mobile UPF:**

- **Small packet traffic** (VoIP, IoT, signaling): Mpps is limiting - plan for 1-2 Gbps per 10 Mpps
- **Modern mobile traffic** (1200-byte average): Plan for ~9-10 Gbps per 10 Mpps capacity
- **Video-heavy traffic** (streaming, downloads): Plan for ~10-12 Gbps per 10 Mpps capacity
- **Always consider both N3 and N6** - N3 has GTP-U overhead, N6 does not

### **Practical Capacity Planning:**

With 1200-byte average packet size (typical for modern mobile networks with video streaming):

<b>NIC Mpps Capacity</b>	<b>N3 Throughput (GTP-U)</b>	<b>N6 Throughput (Native IP)</b>	<b>Realistic Deployment</b>
<b>1 Mpps</b>	~1.0 Gbps	~1.0 Gbps	Small cell site, IoT gateway
<b>5 Mpps</b>	~4.9 Gbps	~4.8 Gbps	Medium cell site, enterprise
<b>10 Mpps</b>	~9.9 Gbps	~9.6 Gbps	Large cell site, small city
<b>20 Mpps</b>	~19.7 Gbps	~19.2 Gbps	Metro area, medium city
<b>40 Mpps</b>	~39.4 Gbps	~38.4 Gbps	Large metro, regional hub

**Note:** These estimates assume 1200-byte average payload size, which is representative of modern mobile traffic dominated by video streaming, social media, and cloud applications. Actual throughput will vary based on traffic mix.

---

## **XDP-Capable Network Drivers**

OmniUPF requires network drivers with XDP support for **native** and **offload** modes. Generic mode works with **any** NIC.

### **Intel NICs**

<b>Model</b>	<b>Driver</b>	<b>XDP Support</b>	<b>Mode</b>	<b>Performance</b>
<b>Intel X710</b>	i40e	Yes	Native	~10 Mpps
<b>Intel XL710</b>	i40e	Yes	Native	~10 Mpps
<b>Intel E810</b>	ice	Yes	Native	~15 Mpps
<b>Intel 82599ES</b>	ixgbe	Yes	Native	~8 Mpps
Intel I350	igb	Limited	Generic	~1 Mpps
Intel E1000	e1000	No	Generic only	~1 Mpps

---

### **Mellanox/NVIDIA NICs**

<b>Model</b>	<b>Driver</b>	<b>XDP Support</b>	<b>Mode</b>	<b>Performance</b>
<b>Mellanox ConnectX-5</b>	mlx5	Yes	Native	~12 Mpps
<b>Mellanox ConnectX-6</b>	mlx5	Yes	Native	~20 Mpps
<b>Mellanox BlueField</b>	mlx5	Yes	Native + Offload	~40 Mpps
<b>Mellanox ConnectX-4</b>	mlx4	Limited	Generic	~2 Mpps

---

### **Broadcom NICs**

Model	Driver	XDP Support	Mode	Performance
<b>Broadcom BCM57xxx</b>	bnxt_en	Yes	Native	~8 Mpps
Broadcom NetXtreme II	bnx2x	No	Generic only	~1 Mpps

---

## Other Vendors

Model	Driver	XDP Support	Mode	Performance
<b>Netronome Agilio CX</b>	nfp	Yes	Offload	~30 Mpps
<b>Amazon ENA</b>	ena	Yes	Native	~5 Mpps
<b>Solarflare SFC9xxx</b>	sfc	Yes	Native	~8 Mpps
VirtIO	virtio_net	Limited	Generic	~2 Mpps

---

## Checking NIC XDP Support

Check if driver supports XDP:

```
Find NIC driver
ethtool -i eth0 | grep driver

Check XDP support in driver
modinfo <driver_name> | grep -i xdp

Example for Intel i40e
modinfo i40e | grep -i xdp
```

### **Verify XDP program attachment:**

```
Check if XDP program is attached
ip link show eth0 | grep -i xdp

Example output (XDP attached):
2: eth0: <BROADCAST,MULTICAST,UP,LOWER_UP> mtu 1500 xdp qdisc mq
```

---

## **Recommended NICs by Use Case**

With 1200-byte average packet size (modern mobile traffic):

Use Case	Recommended NIC	Mode	Mpps Capacity	Throughput (N3)
<b>Testing/Development</b>	Any NIC (VirtIO, E1000)	Generic	1-2 Mpps	1-2 Gbps
<b>Small Cell Site</b>	Intel X710, Mellanox CX-5	Native	5-10 Mpps	5-10 Gbps
<b>Medium Cell/Metro</b>	Intel E810, Mellanox CX-6	Native	10-20 Mpps	10-20 Gbps
<b>Large Metro</b>	Mellanox CX-6, Intel E810 (dual)	Native	20-40 Mpps	20-40 Gbps
<b>Regional Hub</b>	Mellanox BlueField, Netronome Agilio	Offload	40+ Mpps	40+ Gbps
<b>Proxmox VM (Bridge)</b>	VirtIO	Generic	1-2 Mpps	1-2 Gbps
<b>Proxmox VM (SR-IOV)</b>	Intel X710/E810 VF, Mellanox CX-5 VF	Native	5-10 Mpps	5-10 Gbps

### Throughput Estimates:

- Based on 1200-byte average packet size with GTP-U encapsulation (1236 bytes on N3)
- N6 throughput slightly lower (~9.6 Gbps per 10 Mpps) due to no GTP-U overhead
- Actual performance varies with traffic mix - VoIP-heavy networks will see lower throughput

# Additional Resources

## Official XDP Documentation:

- [XDP Project](#)
- [Kernel XDP Documentation](#)

## NIC Compatibility Lists:

- [Cilium XDP Hardware Support](#)
  - [IO Visor XDP Drivers](#)
- 

# Configuration Examples

## Example 1: Development Environment (Generic Mode)

**Scenario:** Testing OmniUPF on laptop or VM without SR-IOV

```
Development config
interface_name: [eth0]
xdp_attach_mode: generic
api_address: :8080
pfcp_address: :8805
pfcp_node_id: 127.0.0.1
n3_address: 127.0.0.1
metrics_address: :9090
logging_level: debug
max_sessions: 1000
```

---

## Example 2: Production Bare Metal (Native Mode)

**Scenario:** Production UPF on bare metal server with Intel X710 NIC

```
Production bare metal config
interface_name: [ens1f0, ens1f1] # N3 on ens1f0, N6 on ens1f1
xdp_attach_mode: native
api_address: :8080
pfc_p_address: 10.100.50.241:8805
pfc_p_node_id: 10.100.50.241
n3_address: 10.100.50.233
n9_address: 10.100.50.234
metrics_address: :9090
logging_level: info
max_sessions: 500000
gtp_peer:
 - 10.100.50.10:2152 # gNB 1
 - 10.100.50.11:2152 # gNB 2
gtp_echo_interval: 30
pfc_p_remote_node:
 - 10.100.50.50 # OmniSMF
heartbeat_interval: 10
feature_ueip: true
ueip_pool: 10.45.0.0/16
buffer_max_packets: 50000
buffer_packet_ttl: 60
```

---

## Example 3: Proxmox VM with SR-IOV (Native Mode)

**Scenario:** Production UPF on Proxmox VM with SR-IOV passthrough

```
Proxmox SR-IOV config
interface_name: [ens1f0] # SR-IOV VF
xdp_attach_mode: native
api_address: :8080
pfc_p_address: 192.168.100.10:8805
pfc_p_node_id: 192.168.100.10
n3_address: 192.168.100.10
metrics_address: :9090
logging_level: info
max_sessions: 100000
gtp_peer:
 - 192.168.100.50:2152
gtp_echo_interval: 15
pfc_p_remote_node:
 - 192.168.100.20 # SMF
```

---

## Example 4: PGW-U Mode (4G EPC)

**Scenario:** OmniUPF acting as PGW-U in 4G EPC network

```
PGW-U configuration
interface_name: [eth0]
xdp_attach_mode: native
api_address: :8080
pfc_p_address: 10.200.1.10:8805
pfc_p_node_id: 10.200.1.10
n3_address: 10.200.1.10 # S5/S8 interface (GTP-U)
metrics_address: :9090
logging_level: info
max_sessions: 200000
gtp_peer:
 - 10.200.1.50:2152 # SGW-U
gtp_echo_interval: 20
pfc_p_remote_node:
 - 10.200.2.10 # OmniPGW-C (Sxb interface)
heartbeat_interval: 5
```

---

## Example 5: Multi-Mode (UPF + PGW-U Simultaneously)

**Scenario:** OmniUPF serving both 5G and 4G networks concurrently

```
Multi-mode configuration
interface_name: [eth0, eth1]
xdp_attach_mode: native
api_address: :8080
pfc_p_address: :8805
pfc_p_node_id: 10.50.1.100
n3_address: 10.50.1.100
n9_address: 10.50.1.101
metrics_address: :9090
logging_level: info
max_sessions: 300000
gtp_peer:
 - 10.50.2.10:2152 # 5G gNB
 - 10.50.2.20:2152 # 4G eNodeB (via SGW-U)
gtp_echo_interval: 15
pfc_p_remote_node:
 - 10.50.3.10 # OmniSMF (5G)
 - 10.50.3.20 # OmniPGW-C (4G)
heartbeat_interval: 10
feature_ueip: true
ueip_pool: 10.60.0.0/16
```

---

## Example 6: SmartNIC Offload Mode

**Scenario:** Ultra-high-throughput deployment with Netronome Agilio CX SmartNIC

```
SmartNIC offload configuration
interface_name: [enp1s0np0] # SmartNIC interface
xdp_attach_mode: offload
api_address: :8080
pfc_p_address: 10.10.1.50:8805
pfc_p_node_id: 10.10.1.50
n3_address: 10.10.1.50
metrics_address: :9090
logging_level: warn # Reduce overhead
max_sessions: 1000000
pdr_map_size: 2000000
far_map_size: 2000000
qer_map_size: 1000000
gtp_peer:
 - 10.10.2.10:2152
 - 10.10.2.20:2152
 - 10.10.2.30:2152
gtp_echo_interval: 30
pfc_p_remote_node:
 - 10.10.3.10
heartbeat_interval: 15
buffer_max_packets: 1000000
buffer_max_total: 1000000
```

---

# Map Sizing and Capacity Planning

## Auto-Sizing (Recommended)

Set `max_sessions` and let OmniUPF calculate map sizes automatically:

```
max_sessions: 100000
Auto-calculated sizes:
PDR: 200,000 entries (2 × max_sessions)
FAR: 200,000 entries (2 × max_sessions)
QER: 100,000 entries (1 × max_sessions)
URR: 200,000 entries (2 × max_sessions)
```

**Memory usage:** ~91 MB for 100K sessions

---

## Manual Sizing

Override auto-calculation for custom requirements:

```
max_sessions: 100000
pdr_map_size: 300000 # Support more PDRs per session
far_map_size: 200000
qer_map_size: 150000 # More QERs than default
urr_map_size: 200000
```

---

## Capacity Estimation

**Calculate maximum sessions:**

```
Max Sessions = min(
 pdr_map_size / 2,
 far_map_size / 2,
 qer_map_size
)
```

**Example:**

- PDR map: 200,000
- FAR map: 200,000
- QER map: 100,000

Max Sessions =  $\min(100,000, 100,000, 100,000) = \mathbf{100,000}$

---

## Memory Requirements

**Per session memory usage:**

- PDR:  $2 \times 212 \text{ B} = 424 \text{ B}$
- FAR:  $2 \times 20 \text{ B} = 40 \text{ B}$
- QER:  $1 \times 36 \text{ B} = 36 \text{ B}$
- URR:  $2 \times 20 \text{ B} = 40 \text{ B}$
- **Total:**  $\sim 540 \text{ B}$  per session

**For 100K sessions:**  $\sim 52 \text{ MB}$  kernel memory

**Recommendation:** Ensure locked memory limit allows  $2\times$  estimated usage:

```
Check current limit
ulimit -l

Set unlimited (required for eBPF)
ulimit -l unlimited
```

---

## Related Documentation

- **Architecture Guide** - eBPF/XDP technical details and performance optimization
- **Rules Management Guide** - PDR, FAR, QER, URR configuration
- **Monitoring Guide** - Statistics, capacity monitoring, and alerting
- **Metrics Reference** - Complete Prometheus metrics reference
- **Web UI Guide** - Control panel operations
- **Operations Guide** - UPF architecture and deployment overview

# Metrics Reference

This document describes all Prometheus metrics exposed by OmniUPF on the `/metrics` endpoint.

## Metric Categories

1. **PFCP message metrics** - Control plane protocol message counters and latency per peer
2. **XDP Action metrics** - Dataplane packet verdicts (drop, pass, redirect, etc.)
3. **Packet metrics** - Received packet counters by protocol type
4. **PFCP Session and Association metrics** - Session and association counts per peer
5. **URR metrics** - Traffic volume counters aggregated per PFCP peer
6. **Packet Buffering metrics** - Packet buffer state, capacity, and throughput
7. **Downlink Data Report (Notification) metrics** - PFCP Session Report Request notifications and FAR index tracking
8. **eBPF Map Capacity metrics** - eBPF map utilization and capacity

## Metrics Reference

### PFCP message metrics

Metrics for tracking PFCP protocol messages between the UPF and control plane nodes.

Metric Name	Type	Labels	Description
upf_pfcp_rx	Counter	message_name, peer_address	Total number of received PFCP messages per message type and peer
upf_pfcp_tx	Counter	message_name, peer_address	Total number of transmitted PFCP messages per message type and peer
upf_pfcp_rx_errors	Counter	message_name, cause_code, peer_address	Total number of PFCP messages rejected with error cause per message type and peer
upf_pfcp_rx_latency	Summary	message_type, peer_address	PFCP message processing duration in microseconds (p50, p90, p99 quantiles) per message type and peer

**Note:** All counters track messages per PFCP peer for granular visibility into control plane node behavior.

## XDP Action metrics

Packet counters by XDP program action/verdict. These metrics track the dataplane decision for each packet.

Metric Name	Type	Labels	Description
upf_xdp_aborted	Counter	none	Total number of packets aborted (XDP_ABORTED)
upf_xdp_drop	Counter	none	Total number of packets dropped (XDP_DROP)
upf_xdp_pass	Counter	none	Total number of packets passed to kernel (XDP_PASS)
upf_xdp_tx	Counter	none	Total number of packets transmitted (XDP_TX)
upf_xdp_redirect	Counter	none	Total number of packets redirected (XDP_REDIRECT)

## Packet metrics

Counters for received packets by protocol type. All metrics use `packet_type` label.

Metric Name	Type	Labels	Description
upf_rx	Counter	<code>packet_type</code>	Total number of received packets by type
upf_route	Counter	<code>packet_type</code>	Total number of packets routed by lookup result

### upf\_rx packet\_type values:

- `arp` - ARP packets
- `icmp` - ICMP packets
- `icmp6` - ICMPv6 packets

- `ip4` - IPv4 packets
- `ip6` - IPv6 packets
- `tcp` - TCP packets
- `udp` - UDP packets
- `other` - Other packet types
- `gtp-echo` - GTP echo request/response
- `gtp-pdu` - GTP-U PDU (encapsulated user data)
- `gtp-other` - Other GTP message types
- `gtp-unexp` - Unexpected/malformed GTP packets

### **upf\_route packet\_type values:**

- `ip4-cache` - IPv4 route cache hits
- `ip4-ok` - IPv4 FIB lookup success
- `ip4-error-drop` - IPv4 FIB lookup failed, packet dropped
- `ip4-error-pass` - IPv4 FIB lookup failed, packet passed to kernel
- `ip6-cache` - IPv6 route cache hits
- `ip6-ok` - IPv6 FIB lookup success
- `ip6-error-drop` - IPv6 FIB lookup failed, packet dropped
- `ip6-error-pass` - IPv6 FIB lookup failed, packet passed to kernel

## **PFCP Session and Association metrics**

Metrics for tracking PFCP sessions and associations between the UPF and control plane nodes.

Metric Name	Type	Labels	Description
upf_pfcps_sessions	Gauge	none	Total number of currently established PFCP sessions (all peers)
upf_pfcps_associations	Gauge	none	Total number of currently established PFCP associations (all peers)
upf_pfcps_association_status	Gauge	node_id, address	PFCP association status per peer (1=up, 0=down)
upf_pfcps_sessions_per_node	Gauge	node_id, address	Number of active PFCP sessions per control plane node

## URR (Usage Reporting Rule) metrics

Traffic volume metrics aggregated per PFCP peer. Each peer's volume represents the sum of all URR counters across all sessions from that control plane node.

Metric Name	Type	Labels	Description
upf_urr_uplink_volume_bytes	Gauge	peer_address	Total uplink traffic volume in bytes for all sessions from this peer
upf_urr_downlink_volume_bytes	Gauge	peer_address	Total downlink traffic volume in bytes for all sessions from this peer
upf_urr_total_volume_bytes	Gauge	peer_address	Total traffic volume in bytes (uplink + downlink) for all sessions from this peer

**Note:** Volumes are aggregated per PFCP peer to avoid high cardinality issues. Individual URR statistics are available via the REST API at `/api/v1/urr_map`.

## Packet Buffering metrics

Metrics for tracking packet buffer state and performance. The UPF can buffer downlink packets when a UE is in idle state, holding them until the UE is paged and transitions to connected state.

Metric Name	Type	Labels	Unit
upf_buffer_packets_total	Counter	none	packets
upf_buffer_packets_dropped	Counter	reason	packets
upf_buffer_packets_flushed	Counter	none	packets
upf_buffer_packets_current	Gauge	none	packets
upf_buffer_bytes_total	Counter	none	bytes
upf_buffer_bytes_current	Gauge	none	bytes
upf_buffer_fars_active	Gauge	none	count

Metric Name	Type	Labels	Dimensions
			Flow
upf_buffer_listener_packets_received_total	Counter	none	Traffic
upf_buffer_listener_packets_buffered_total	Counter	none	Traffic
upf_buffer_listener_errors_total	Counter	type	Error
upf_buffer_listener_error_indications_sent_total	Counter	remote_peer	Traffic
upf_buffer_flush_success_total	Counter	none	Traffic

Metric Name	Type	Labels	D
			b c
upf_buffer_flush_errors_total	Counter	reason	T b c
upf_buffer_flush_packets_sent_total	Counter	none	T P c c

#### upf\_buffer\_packets\_dropped reason values:

- `expired` - Packets dropped due to TTL expiration
- `global_limit` - Dropped due to total buffer limit reached
- `far_limit` - Dropped due to per-FAR buffer limit reached
- `cleared` - Packets manually cleared from buffer

#### upf\_buffer\_listener\_errors\_total type values:

- `read_error` - Error reading from buffer socket
- `too_small` - Packet too small for GTP header
- `invalid_gtp_type` - Non-G-PDU GTP message type
- `unknown_teid` - No PDR/FAR found for TEID
- `not_buffering_far` - FAR does not have BUFF action
- `truncated_ext` - Truncated GTP extension headers
- `no_payload` - GTP packet has no payload
- `buffer_full` - Buffer capacity exceeded

#### upf\_buffer\_flush\_errors\_total reason values:

- `far_lookup_failed` - Failed to lookup FAR info from eBPF map
- `no_forw_action` - FAR does not have FORW action set
- `connection_failed` - Failed to create UDP connection for flushing

## **Downlink Data Report (Notification) metrics**

Metrics for PFCP Session Report Request notifications sent to control plane when packets are buffered. These notifications trigger the control plane to page the UE.

Metric Name	Type	Labels	De
upf_dldr_sent_total	Counter	none	Tota of D Data (DLI noti sent
upf_dldr_send_errors	Counter	none	Tota of e send Dow Rep noti
upf_dldr_active_notifications	Gauge	none	Curr num FAR acti noti (not clea
upf_far_index_size	Gauge	none	Curr num FAR regi FarL DLD noti
upf_far_index_registrations_total	Counter	none	Tota of F, regi FarL

Metric Name	Type	Labels	De
upf_far_index_unregistrations_total	Counter	none	Tota of F unre fron
upf_buffer_notify_to_flush_duration_seconds	Histogram	pfcp_peer	Tim sen noti and buff pac

### upf\_buffer\_notify\_to\_flush\_duration\_seconds:

- Histogram buckets: 0.01, 0.05, 0.1, 0.5, 1.0, 2.0, 5.0, 10.0, 30.0, 60.0 seconds
- Label pfcp\_peer: SMF/PGW-C address (e.g., 10.100.50.241)
- Measures the latency between UPF sending notification to SMF and SMF responding with session modification to flush packets
- Useful for monitoring control plane responsiveness during idle-to-connected transitions

## GTP-U Error Indication metrics

Metrics for tracking GTP-U Error Indication messages sent and received. Error Indications are sent when a peer receives packets for unknown TEIDs, indicating tunnel state mismatches (often due to peer restarts).

Metric Name	Type	Labels
upf_buffer_listener_error_indications_sent_total	Counter	node_id peer_address
upf_buffer_listener_error_indications_received_total	Counter	node_id peer_address
upf_buffer_listener_error_indication_sessions_deleted_total	Counter	node_id peer_address

### Label Definitions:

- `node_id`: PFCP Node ID from the association (e.g., "pgw-u-1", "smf-1"). Set to "unknown" if no PFCP association exists for that peer.
- `peer_address`: IP address of the remote peer (e.g., "192.168.50.10")

### When Error Indications Are Sent:

- UPF receives GTP-U packet for a TEID that doesn't exist (e.g., after UPF restart, session already deleted)
- Sender (eNodeB, gNodeB, upstream UPF) is forwarding to stale/deleted tunnel
- UPF sends Error Indication to inform sender to stop sending

## When Error Indications Are Received:

- UPF forwards GTP-U packet to downstream peer (PGW-U, SGW-U, UPF) for unknown TEID
- Remote peer doesn't recognize the destination TEID (e.g., peer restarted and lost tunnel state)
- UPF automatically deletes affected sessions to stop forwarding to dead tunnels

## Use Cases:

- Detect peer restarts (high Error Indication rate indicates state loss)
- Identify configuration mismatches (TEID allocation issues)
- Monitor tunnel synchronization health between network elements
- Alert on unexpected session deletions

## Example PromQL Queries:

```
Rate of Error Indications received per peer (per second)
rate(upf_buffer_listener_error_indications_received_total[5m])

Total sessions deleted due to Error Indications from specific peer
upf_buffer_listener_error_indication_sessions_deleted_total{peer_address}

Peers sending unknown TEIDs to this UPF
sum by (node_id, peer_address) (upf_buffer_listener_error_indications
```

## eBPF Map Capacity metrics

Metrics for tracking eBPF map utilization. These metrics help monitor resource usage and detect potential capacity issues.

Metric Name	Type	Labels	Description
upf_ebpf_map_capacity	Gauge	map_name	Maximum capacity of eBPF map
upf_ebpf_map_used	Gauge	map_name	Current number of entries in eBPF map

### Common map\_name values:

- pdr\_map - Packet Detection Rule map
- far\_map - Forwarding Action Rule map
- qer\_map - QoS Enforcement Rule map
- session\_map - Session lookup map
- teid\_map - TEID to session mapping
- ue\_ip\_map - UE IP address to session mapping

# Using Prometheus Metrics

## Accessing Metrics

Metrics are exposed on the `/metrics` endpoint at the address specified by `metrics_address` in the configuration file (default `:9090`):

```
View raw metrics
curl http://localhost:9090/metrics

Example output
upf_pfcps_sessions 42
upf_pfcps_associations 2
upf_urr_total_volume_bytes{peer_address="10.100.50.241"}
1048576000
```

# Prometheus Configuration

Add the OmniUPF target to your `prometheus.yml`:

```
scrape_configs:
 - job_name: 'omniupf'
 static_configs:
 - targets: ['localhost:9090']
```

## Grafana Dashboards

Import metrics into Grafana for visualization:

- Session counts and trends
- Traffic volume per PFCP peer
- Packet processing rates
- Buffer utilization
- eBPF map capacity monitoring

## Related Documentation

- **Monitoring Guide** - Statistics monitoring, capacity planning, and alerting
- **Configuration Guide** - Configure `metrics_address` and other UPF options
- **Web UI Guide** - View metrics in the Statistics page
- **Architecture Guide** - eBPF datapath and performance optimization
- **Rules Management Guide** - Understanding PDR, FAR, QER, URR metrics
- **Troubleshooting Guide** - Using metrics for diagnostics

# Monitoring Guide

## Table of Contents

1. [Overview](#)
2. [Statistics Monitoring](#)
3. [Capacity Monitoring](#)
4. [Performance Metrics](#)
5. [Alerting and Thresholds](#)
6. [Capacity Planning](#)
7. [Troubleshooting Performance Issues](#)

## Overview

Effective monitoring of OmniUPF is critical for maintaining service quality, preventing capacity exhaustion, and troubleshooting performance issues. OmniUPF provides comprehensive real-time metrics through its Web UI and REST API.

# Monitoring Categories

Category	Purpose	Update Frequency	Key Metrics
<b>Packet Statistics</b>	Track packet processing rates and errors	Real-time	RX/TX packets, drops, protocol breakdown
<b>Interface Statistics</b>	Monitor N3/N6 traffic distribution	Real-time	N3 RX/TX, N6 RX/TX
<b>XDP Statistics</b>	Track kernel datapath performance	Real-time	XDP processed, passed, dropped, aborted
<b>Route Statistics</b>	Monitor packet routing decisions	Real-time	FIB lookups, cache hits/misses
<b>eBPF Map Capacity</b>	Prevent resource exhaustion	Every 10s	Map usage percentages, used vs. capacity
<b>Buffer Statistics</b>	Track packet buffering during mobility	Every 5s	Buffered packets, buffer age, FAR count

## Statistics Monitoring

### N3/N6 Interface Statistics

N3/N6 interface statistics provide visibility into traffic distribution between the RAN (N3) and Data Network (N6).

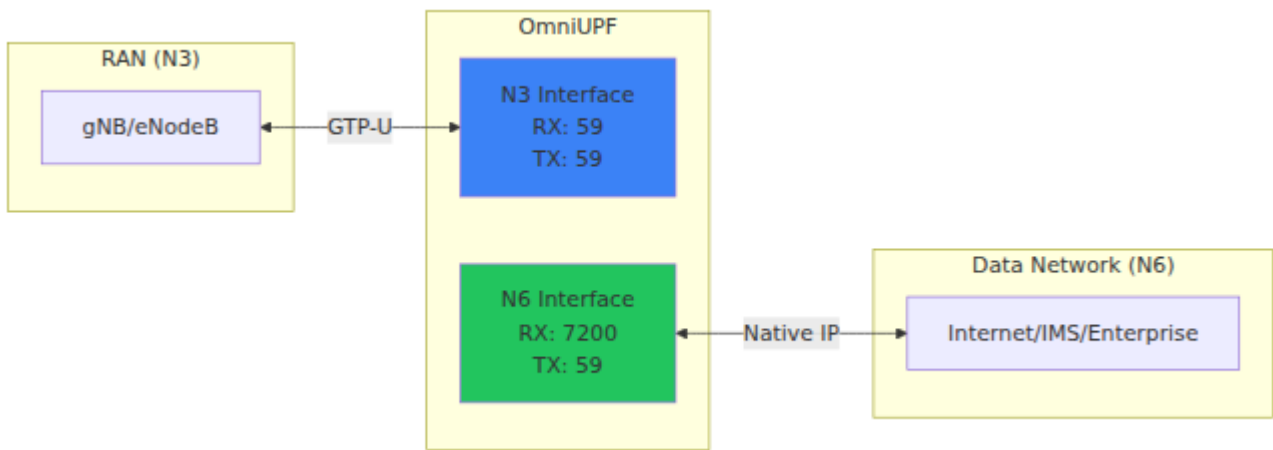

### Metrics:

- **RX N3:** Packets received from RAN (uplink GTP-U traffic)
- **TX N3:** Packets transmitted to RAN (downlink GTP-U traffic)
- **RX N6:** Packets received from Data Network (downlink native IP)
- **TX N6:** Packets transmitted to Data Network (uplink native IP)
- **Total:** Aggregate packet count across all interfaces

### Expected Behavior:

- **RX N3  $\approx$  TX N6:** Uplink packets flow from RAN to Data Network
- **RX N6  $\approx$  TX N3:** Downlink packets flow from Data Network to RAN
- Significant imbalance may indicate:
  - Asymmetric traffic (downloads  $\gg$  uploads)
  - Packet drops or forwarding errors
  - Routing misconfigurations

---

## XDP Statistics

XDP (eXpress Data Path) statistics show kernel-level packet processing performance.

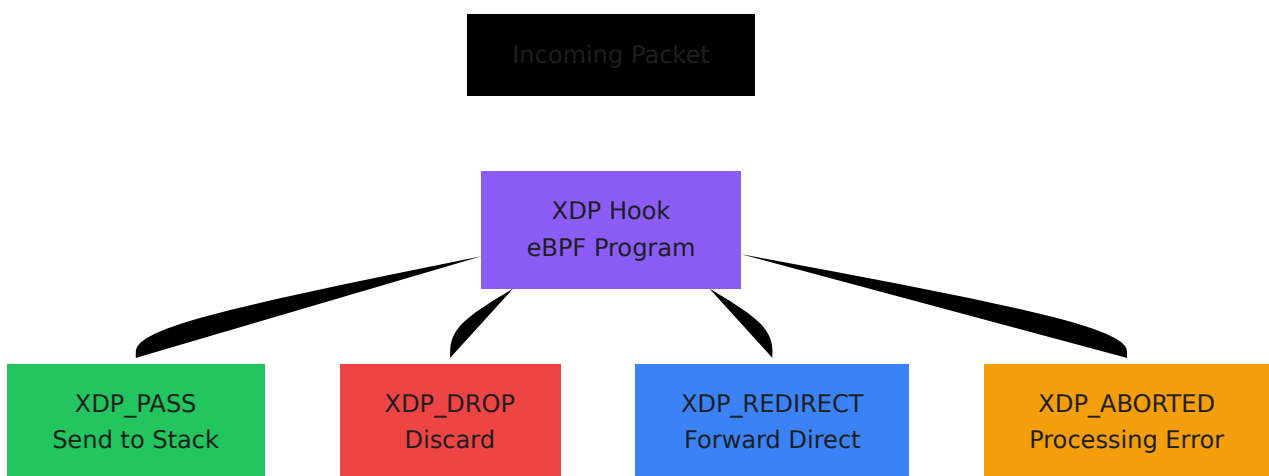

### Metrics:

- **Aborted:** XDP program encountered an error (should always be 0)

- **Drop:** Packets intentionally dropped by XDP program
- **Pass:** Packets passed to network stack for further processing
- **Redirect:** Packets directly redirected to output interface
- **TX:** Packets transmitted via XDP

### Interpretation:

- **Aborted > 0:** Critical issue with eBPF program or kernel compatibility
  - **Drop > 0:** Policy-based drops or invalid packets
  - **Pass high:** Most packets processed in network stack (normal)
  - **Redirect high:** Packets forwarded directly (optimal performance)
- 

## Packet Statistics

Detailed packet protocol breakdown and processing counters.

### Protocol Counters:

- **RX ARP:** Address Resolution Protocol packets
- **RX GTP ECHO:** GTP-U Echo Request/Response (keepalive)
- **RX GTP OTHER:** Other GTP control messages
- **RX GTP PDU:** GTP-U encapsulated user data (main traffic)
- **RX GTP UNEXP:** Unexpected GTP packet types
- **RX ICMP:** Internet Control Message Protocol (ping, errors)
- **RX ICMP6:** ICMPv6 packets
- **RX IP4:** IPv4 packets
- **RX IP6:** IPv6 packets
- **RX OTHER:** Other protocols
- **RX TCP:** Transmission Control Protocol packets
- **RX UDP:** User Datagram Protocol packets

### Use Cases:

- **Monitor GTP-U PDU count:** Primary user traffic indicator
- **Check ICMP for connectivity:** Network reachability testing

- **Track TCP vs UDP ratio:** Application traffic patterns
  - **Detect unexpected protocols:** Security or misconfiguration issues
- 

## Route Statistics

FIB (Forwarding Information Base) lookup statistics for routing decisions.

### IPv4 FIB Lookup:

- **Cache:** Cached route lookups (fast path)
- **OK:** Successful route lookups

### IPv6 FIB Lookup:

- **Cache:** Cached IPv6 route lookups
- **OK:** Successful IPv6 route lookups

### Performance Indicators:

- **High Cache Hit Rate:** Indicates good routing cache performance
  - **High OK Count:** Confirms routing tables are correctly configured
  - **Low or Zero Lookups:** May indicate traffic not flowing or routing bypass
- 

# Capacity Monitoring

## eBPF Map Capacity

eBPF map capacity monitoring prevents session establishment failures due to resource exhaustion.

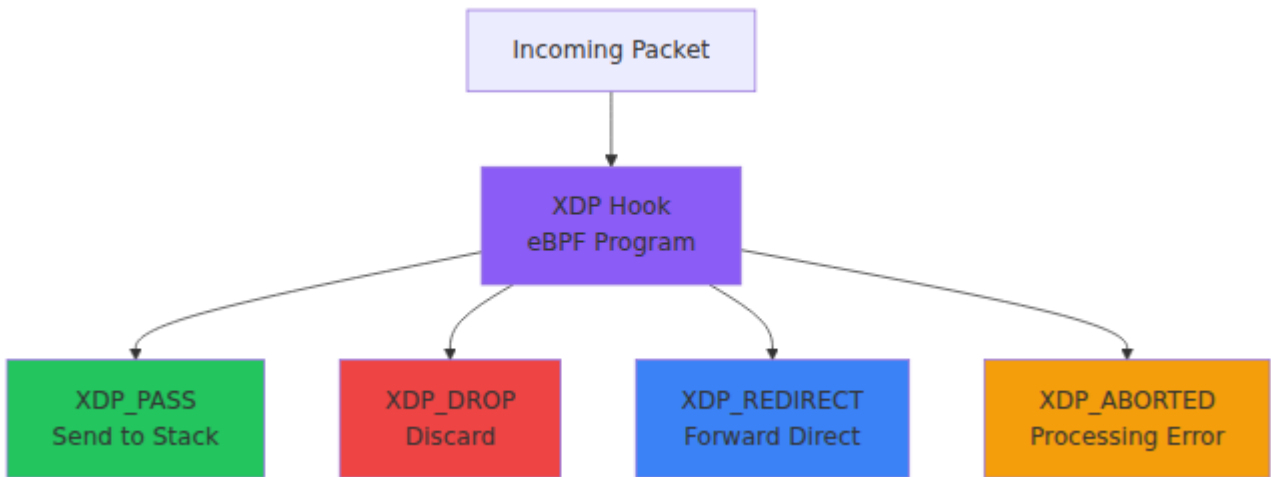

## Critical eBPF Maps

**far\_map** (Forwarding Action Rules):

- **Capacity:** 131,070 entries
- **Key Size:** 4 B (FAR ID)
- **Value Size:** 16 B (forwarding parameters)
- **Memory Usage:** ~2.6 MB
- **Criticality:** High - Used for all packet forwarding decisions

**pdr\_map\_downlin** (Downlink PDRs - IPv4):

- **Capacity:** 131,070 entries
- **Key Size:** 4 B (UE IPv4 address)
- **Value Size:** 208 B (PDR info)
- **Memory Usage:** ~27 MB
- **Criticality:** Critical - Session establishment fails if full

**pdr\_map\_downlin\_ip6** (Downlink PDRs - IPv6):

- **Capacity:** 131,070 entries
- **Key Size:** 16 B (UE IPv6 address)
- **Value Size:** 208 B (PDR info)
- **Memory Usage:** ~29 MB
- **Criticality:** Critical - IPv6 session establishment fails if full

**pdr\_map\_teid\_ip** (Uplink PDRs):

- **Capacity:** 131,070 entries
- **Key Size:** 4 B (TEID)
- **Value Size:** 208 B (PDR info)
- **Memory Usage:** ~27 MB
- **Criticality:** Critical - Uplink traffic fails if full

**qer\_map** (QoS Enforcement Rules):

- **Capacity:** 65,535 entries
- **Key Size:** 4 B (QER ID)
- **Value Size:** 32 B (QoS parameters)
- **Memory Usage:** ~2.3 MB
- **Criticality:** Medium - QoS enforcement only

**urr\_map** (Usage Reporting Rules):

- **Capacity:** 131,070 entries
- **Key Size:** 4 B (URR ID)
- **Value Size:** 16 B (volume counters)
- **Memory Usage:** ~2.6 MB
- **Criticality:** Low - Affects charging only

## Capacity Thresholds

Threshold	Action Required
<b>0-50% (Green)</b>	Normal operation - No action required
<b>50-70% (Yellow)</b>	Caution - Monitor growth trends, plan capacity increase
<b>70-90% (Amber)</b>	Warning - Schedule capacity increase within 1 week
<b>90-100% (Red)</b>	Critical - Immediate action required, new sessions will fail

# Capacity Increase Procedure

## Before increasing capacity:

1. Review current usage trends
2. Estimate future growth rate
3. Calculate required capacity

## Steps to increase map capacity:

1. Stop OmniUPF service
2. Update UPF configuration file with new map sizes
3. Restart OmniUPF service
4. Verify new capacity in Capacity view
5. Monitor for successful session establishment

**Note:** Changing eBPF map capacity requires UPF restart and clears all existing sessions.

---

# Performance Metrics

For detailed information about all Prometheus metrics exposed by OmniUPF, see the [Metrics Reference](#).

## Packet Processing Rate

### Calculation:

$$\text{Packet Rate (pps)} = (\text{Packet Count Delta}) / (\text{Time Delta in seconds})$$

### Example:

- Initial RX packets: 7,000
- After 10 seconds: 17,000
- Packet Rate =  $(17,000 - 7,000) / 10 = 1,000$  pps

## Performance Targets:

- **Small UPF:** 10,000 - 100,000 pps
- **Medium UPF:** 100,000 - 1,000,000 pps
- **Large UPF:** 1,000,000 - 10,000,000 pps

## Bottleneck Indicators:

- XDP aborted count increasing
  - High CPU utilization
  - Packet drops increasing
  - Latency increasing
- 

# Throughput Calculation

## Calculation:

```
Throughput (Mbps) = (Byte Count Delta × 8) / (Time Delta in seconds × 1,000,000)
```

## Example:

- Initial RX bytes: 500 MB
- After 60 seconds: 800 MB
- Throughput =  $(300 \text{ MB} \times 8) / (60 \times 1,000,000) = 40 \text{ Mbps}$

## Capacity Planning:

- Monitor peak throughput times (e.g., evening hours)
  - Compare to link capacity (N3/N6 interface speeds)
  - Plan for 2x peak throughput for headroom
- 

# Drop Rate

## Calculation:

$$\text{Drop Rate (\%)} = (\text{Dropped Packets} / \text{Total RX Packets}) \times 100$$

### Acceptable Thresholds:

- < **0.1%**: Excellent (normal packet loss due to errors)
- **0.1% - 1%**: Good (minor issues or rate limiting)
- **1% - 5%**: Poor (investigate QoS or capacity issues)
- > **5%**: Critical (major forwarding or capacity problem)

### Common Drop Causes:

- QER rate limiting (MBR exceeded)
  - eBPF map lookup failures
  - Invalid TEIDs or UE IPs
  - Routing errors
- 

# Alerting and Thresholds

## Recommended Alerts

### Critical Alerts (Immediate response required):

- eBPF map capacity > 90%
- XDP aborted count > 0
- Drop rate > 5%
- UPF health check failed

### Warning Alerts (Response within 1 hour):

- eBPF map capacity > 70%
- Drop rate > 1%
- Packet rate approaching link capacity
- Buffer TTL exceeded (packets older than 30s)

## Informational Alerts (Monitor trends):

- eBPF map capacity > 50%
- Buffered packet count increasing
- New PFCP associations established/released
- URR volume thresholds exceeded

## Alert Configuration

Alerts can be configured via:

1. **Prometheus Metrics:** Export metrics for external monitoring (see [Metrics Reference](#) for complete list)
  2. **Log Monitoring:** Parse OmniUPF logs for error patterns
  3. **REST API Polling:** Periodically query `/map_info`, `/packet_stats` endpoints
  4. **Web UI Monitoring:** Manual monitoring via Statistics and Capacity pages
- 

# Capacity Planning

## Session Capacity Estimation

Calculate maximum sessions:

```
Max Sessions = min(
 PDR Map Capacity / 2, # Downlink + Uplink PDRs per session
 FAR Map Capacity / 2, # Downlink + Uplink FARs per session
 QER Map Capacity # Optional, one QER per session
)
```

**Example:**

- PDR Map Capacity: 131,070
- FAR Map Capacity: 131,070

- QER Map Capacity: 65,535

Max Sessions =  $\min(131,070 / 2, 131,070 / 2, 65,535) = \mathbf{65,535 \text{ sessions}}$

## Memory Capacity

**Calculate total eBPF map memory:**

```
Memory = Σ (Map Capacity \times (Key Size + Value Size))
```

**Example Configuration:**

- PDR maps:  $3 \times 131,070 \times 212 \text{ B} = 83.3 \text{ MB}$
- FAR map:  $131,070 \times 20 \text{ B} = 2.6 \text{ MB}$
- QER map:  $65,535 \times 36 \text{ B} = 2.3 \text{ MB}$
- URR map:  $131,070 \times 20 \text{ B} = 2.6 \text{ MB}$
- **Total:**  $\sim 91 \text{ MB}$  of kernel memory

**Kernel Memory Considerations:**

- Ensure sufficient locked memory limit (`ulimit -l`)
- Reserve 2x estimated usage for safety margin
- Monitor kernel memory availability

## Traffic Capacity

**Calculate required throughput capacity:**

**1. Estimate average session throughput:**

- Video streaming:  $\sim 5 \text{ Mbps}$
- Web browsing:  $\sim 1 \text{ Mbps}$
- VoIP:  $\sim 0.1 \text{ Mbps}$

**2. Calculate aggregate throughput:**

Total Throughput = Sessions × Average Session Throughput

### 3. Add headroom:

Required Capacity = Total Throughput × 2 # 100% headroom

#### Example:

- 10,000 concurrent sessions
- Average 2 Mbps per session
- Total: 20 Gbps
- Required capacity: 40 Gbps (N3 + N6 interfaces)

## Growth Planning

#### Trend Analysis:

1. Record daily peak session count
2. Calculate weekly growth rate
3. Extrapolate to capacity limit

#### Growth Rate Formula:

Weeks to Capacity = (Capacity - Current Usage) / (Weekly Growth)

#### Example:

- Current sessions: 30,000
- Capacity: 65,535 sessions
- Weekly growth: 2,000 sessions
- Weeks to capacity:  $(65,535 - 30,000) / 2,000 = \mathbf{17.8 \text{ weeks}}$

**Action:** Plan capacity upgrade in 12 weeks (leaving 5 weeks buffer).

---

# Troubleshooting Performance Issues

## High Packet Drop Rate

**Symptoms:** Drop rate > 1%, user complaints of poor connectivity

**Diagnosis:**

1. Check Statistics → Packet Statistics
2. Identify if drops are protocol-specific
3. Review XDP Statistics for XDP drops vs. aborts

**Common Causes:**

- **QER Rate Limiting:** Check QER MBR values vs. actual traffic
- **Invalid TEIDs:** Verify uplink PDR TEID matches gNB assignment
- **Unknown UE IPs:** Verify downlink PDR exists for UE IP
- **Buffer Overflow:** Check buffer statistics

**Resolution:**

- Increase QER MBR if rate limiting
- Verify SMF has created correct PDRs
- Clear buffers if overflow detected

---

## XDP Processing Errors

**Symptoms:** XDP aborted > 0

**Diagnosis:**

1. Navigate to Statistics → XDP Statistics
2. Check aborted counter
3. Review OmniUPF logs for eBPF errors

## **Common Causes:**

- eBPF program verification failure
- Kernel version incompatibility
- eBPF map access errors
- Memory corruption

## **Resolution:**

- Restart OmniUPF service
  - Check kernel version meets minimum requirements (Linux 5.4+)
  - Review eBPF program logs
  - Contact support if issue persists
- 

# **Capacity Exhaustion**

**Symptoms:** Session establishment failures, map capacity at 100%

## **Diagnosis:**

1. Navigate to Capacity page
2. Identify which map is at 100%
3. Check if sessions are stuck (not being deleted)

## **Immediate Mitigation:**

1. Identify stale sessions (check Sessions page)
2. Request SMF to delete old sessions
3. Clear buffers to free FAR entries

## **Long-term Resolution:**

1. Increase eBPF map capacity
  2. Schedule UPF restart with larger maps
  3. Implement session cleanup policies
-

# Performance Degradation

**Symptoms:** High latency, low throughput, CPU saturation

## Diagnosis:

1. Check packet rate vs. historical baseline
2. Review XDP statistics for processing delays
3. Monitor CPU utilization on UPF host
4. Check N3/N6 interface utilization

## Common Causes:

- Traffic exceeding UPF capacity
- Insufficient CPU cores for packet processing
- Network interface bottleneck
- eBPF map hash collisions

## Resolution:

- Scale UPF horizontally (add more instances)
  - Upgrade CPU or enable RSS (Receive Side Scaling)
  - Upgrade network interfaces to higher speed
  - Tune eBPF map hash function
- 

# Related Documentation

- **Metrics Reference** - Complete Prometheus metrics reference
- **UPF Operations Guide** - General UPF architecture and operations
- **Rules Management Guide** - PDR, FAR, QER, URR configuration
- **Web UI Operations Guide** - Control panel monitoring features
- **Troubleshooting Guide** - Common issues and diagnostics
- **Architecture Guide** - eBPF datapath and performance optimization

# N9 Loopback: Running SGWU and PGWU on Same Instance

## Overview

OmniUPF supports running both **SGWU (Serving Gateway User Plane)** and **PGWU (PDN Gateway User Plane)** functions on the **same instance** with **zero-latency N9 loopback**. This deployment mode is ideal for:

- **Simplified 4G EPC deployments** - Single UPF instance instead of two
- **Cost optimization** - Reduced infrastructure and operational complexity
- **Edge computing** - Minimize latency for local breakout scenarios
- **Lab/testing environments** - Full EPC user plane on single server

When configured with the same IP address for both N3 and N9 interfaces, OmniUPF **automatically detects** traffic flowing between the SGWU and PGWU roles and processes it **entirely in eBPF** without ever sending packets to the network interface.

---

## How It Works

### Traditional Deployment (Two Instances)

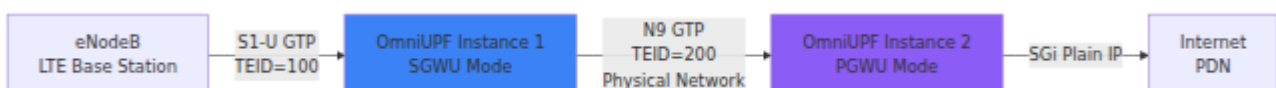

#### Packet Flow:

1. eNodeB → SGWU: GTP packet (TEID=100) arrives on S1-U
2. SGWU: Matches uplink PDR, encapsulates in new GTP tunnel (TEID=200)

3. **Packet sent over physical N9 network** to PGWU instance
4. PGWU: Receives GTP (TEID=200), decapsulates, forwards to Internet
5. **Total: 2 XDP passes + 1 network hop**

## N9 Loopback Deployment (Single Instance)

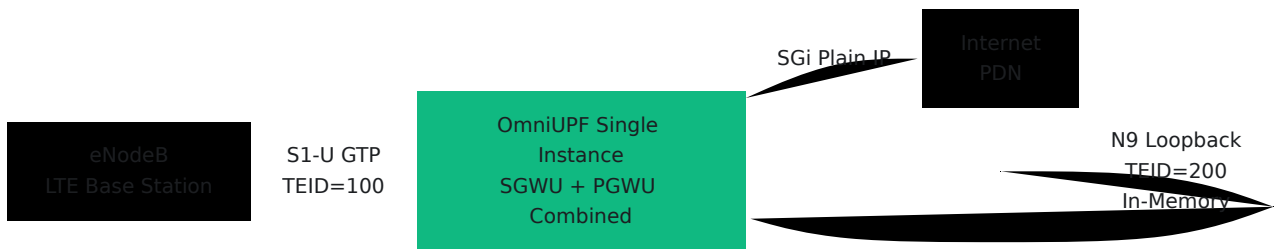

### Packet Flow with N9 Loopback:

1. eNodeB → SGWU role: GTP packet (TEID=100) arrives on S1-U
2. SGWU role: Matches uplink PDR
3. **Loopback detection:** Destination IP = local IP (10.0.1.10)
4. **In-place processing:** Update GTP TEID to 200 (PGWU session)
5. PGWU role: Decapsulates, forwards to Internet
6. **Total: 1 XDP pass, zero network hops**

**Performance benefit:** Sub-microsecond internal forwarding vs milliseconds for network round-trip

## Packet Processing Details

### Uplink Flow: eNodeB → SGWU → PGWU → Internet

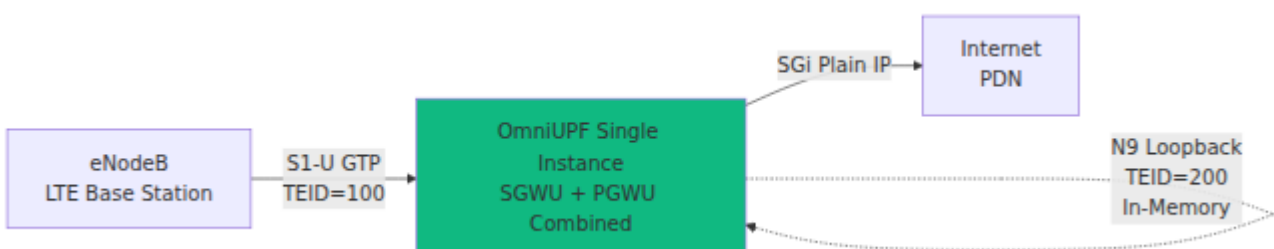

**Code Path:** `cmd/ebpf/xdp/n3n6_entrypoint.c` lines 349-403

### Key Steps:

1. **Receive:** GTP packet from eNodeB with TEID=100
2. **PDR Match:** Lookup uplink PDR for SGWU session (TEID=100)
3. **FAR Action:** Encapsulate in GTP with TEID=200, forward to 10.0.1.10
4. **Loopback Check:** `is_local_ip(10.0.1.10)` returns TRUE
5. **Update TEID:** Change `ctx->gtp->teid` from 100 to 200 (in kernel memory)
6. **Re-Process:** Lookup PDR for TEID=200 (PGWU session)
7. **FAR Action:** Remove GTP header, forward to Internet
8. **Route:** Send plain IP packet to N6 interface

## Downlink Flow: Internet → PGWU → SGWU → eNodeB

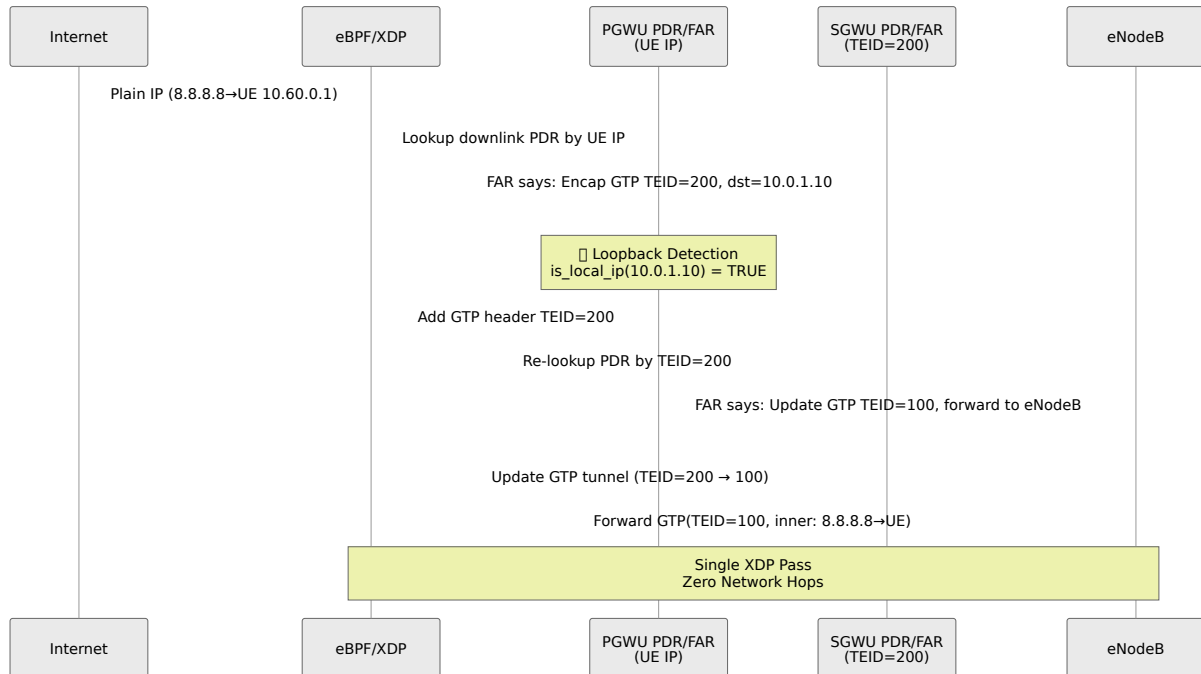

**Code Path:** `cmd/ebpf/xdp/n3n6_entrypoint.c` lines 137-194 (IPv4), 265-322 (IPv6)

### Key Steps:

1. **Receive:** Plain IP packet from Internet destined to UE (10.60.0.1)
  2. **PDR Match:** Lookup downlink PDR by UE IP (PGWU session)
  3. **FAR Action:** Encapsulate in GTP with TEID=200, forward to 10.0.1.10
  4. **Loopback Check:** `is_local_ip(10.0.1.10)` returns TRUE
  5. **Add GTP:** Encapsulate packet with TEID=200
  6. **Re-Process:** Lookup PDR for TEID=200 (SGWU session)
  7. **FAR Action:** Update GTP tunnel to eNodeB TEID=100
  8. **Route:** Send GTP packet to S1-U interface (eNodeB)
- 

# Configuration

## Requirements

### Control Plane:

- **SGWU-C:** Must connect to OmniUPF PFCP interface (e.g., `192.168.1.10:8805`)
- **PGWU-C:** Must connect to **same** OmniUPF PFCP interface

### Network:

- **Single IP address** for both N3 and N9 interfaces
  - **Different IP addresses** for SGWU-C and PGWU-C (if running on same host, use different ports)
- 

## OmniUPF Configuration

### config.yml:

```

Network interfaces
interface_name: [eth0] # Single interface for S1-U
and N9 # Use native for best
xdp_attach_mode: native # Use native for best
performance

PFCP Interface
pfcip_address: ":8805" # Listen on all interfaces,
port 8805 # Listen on all interfaces,
pfcip_node_id: "192.168.1.10" # OmniUPF's PFCP Node ID

User Plane Interfaces
n3_address: "10.0.1.10" # S1-U/N3 interface IP
n9_address: "10.0.1.10" # N9 interface IP (SAME as N3)

APIs
api_address: ":8080" # REST API
metrics_address: ":9090" # Prometheus metrics (see
Metrics Reference doc)

Resource Pools
ueip_pool: "10.60.0.0/16" # UE IP address pool
teid_pool: 65535 # TEID allocation pool

Capacity
max_sessions: 100000 # Maximum concurrent UE
sessions

```

## Key Configuration:

- `n3_address` and `n9_address` **MUST be identical** to enable loopback
- Single PFCP listening address for both control planes
- Sufficient `max_sessions` for combined SGWU + PGWU load

# Control Plane Configuration

## SGWU-C Configuration

```
Point to OmniUPF PFCP interface
upf_pfcip_address: "192.168.1.10:8805"

S1-U interface (same as OmniUPF n3_address)
sgwu_s1u_address: "10.0.1.10"

N9 interface for forwarding to PGWU (same as OmniUPF)
sgwu_n9_address: "10.0.1.10"
```

## PGWU-C Configuration

```
Point to SAME OmniUPF PFCP interface
upf_pfcip_address: "192.168.1.10:8805"

N9 interface (receives from SGWU)
pgwu_n9_address: "10.0.1.10"

SGi interface for Internet connectivity
pgwu_sgi_address: "192.168.100.1"
```

### Important:

- Both control planes connect to **same PFCP endpoint** (:8805)
- OmniUPF creates **separate PFCP associations** for SGWU-C and PGWU-C
- Sessions are isolated per control plane (tracked by Node ID)

---

# Session Flow Example

## UE Attach and PDU Session Establishment

**Scenario:** UE attaches to network, establishes data session

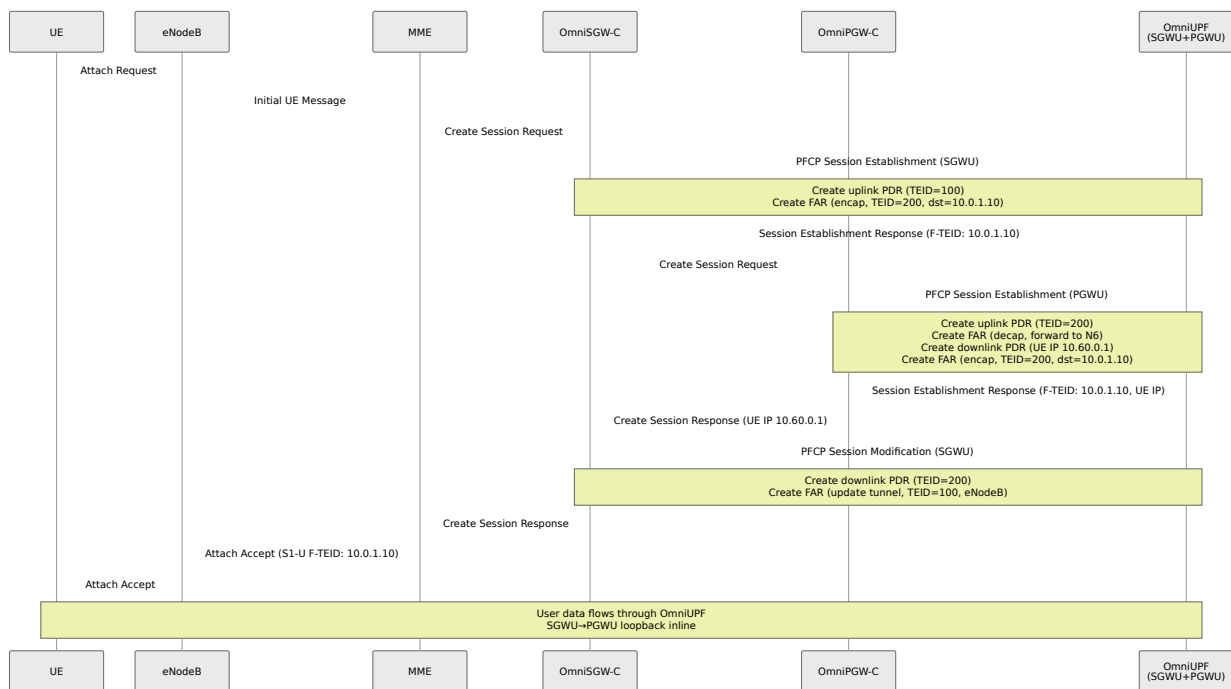

## PFCP Sessions Created:

### SGWU Session (from OmniSGW-C):

- **Uplink PDR:** Match TEID=100 (from eNodeB) → FAR: Encapsulate TEID=200, dst=10.0.1.10
- **Downlink PDR:** Match TEID=200 (from PGWU) → FAR: Update tunnel TEID=100, forward to eNodeB

### PGWU Session (from OmniPGW-C):

- **Uplink PDR:** Match TEID=200 (from SGWU) → FAR: Decapsulate, forward to Internet
- **Downlink PDR:** Match UE IP=10.60.0.1 → FAR: Encapsulate TEID=200, dst=10.0.1.10

# Monitoring and Verification

## Verify N9 Loopback is Active

Check XDP Logs:

```
View real-time eBPF debug output
sudo cat /sys/kernel/debug/tracing/trace_pipe | grep loopback
```

### **Expected output:**

```
upf: [n3] session for teid:100 -> 200 remote:10.0.1.10
upf: [n9-loopback] self-forwarding detected, processing inline
TEID:200
upf: [n9-loopback] decapsulated, routing to N6

upf: [n6] use mapping 10.60.0.1 -> teid:200
upf: [n6-loopback] downlink self-forwarding detected, processing
inline TEID:200
upf: [n6-loopback] SGWU updating GTP tunnel to eNodeB TEID:100
upf: [n6-loopback] forwarding to eNodeB
```

---

## **Monitor Sessions via REST API**

### **List PFCP Associations:**

```
curl http://localhost:8080/api/v1/upf_pipeline | jq
```

### **Expected output:**

```
{
 "associations": [
 {
 "node_id": "sgwc.example.com",
 "address": "192.168.1.20:8805",
 "sessions": 1000
 },
 {
 "node_id": "pgwc.example.com",
 "address": "192.168.1.21:8805",
 "sessions": 1000
 }
],
 "total_sessions": 2000
}
```

**Verify two separate associations** (one for SGWU-C, one for PGWU-C)

---

### List Active Sessions:

```
curl http://localhost:8080/api/v1/sessions | jq '.sessions[] | {local_seid, ue_ip, uplink_teid}'
```

### Expected output:

```
{
 "local_seid": 12345,
 "ue_ip": "10.60.0.1",
 "uplink_teid": 100
}
{
 "local_seid": 67890,
 "ue_ip": "10.60.0.1",
 "uplink_teid": 200
}
```

**Each UE has TWO sessions:**

- Session from SGWU-C (TEID=100, S1-U interface)
  - Session from PGWU-C (TEID=200, N9 interface)
- 

## Performance Metrics

### Check Packet Statistics:

```
curl http://localhost:8080/api/v1/xdp_stats | jq
```

### Key metrics:

- `xdp_processed`: Total packets processed in eBPF
- `xdp_pass`: Packets passed to network stack (should be zero for loopback traffic)
- `xdp_redirect`: Packets forwarded via XDP redirect
- `xdp_tx`: Packets transmitted (loopback traffic uses this)

### For N9 loopback traffic:

- `xdp_pass` should be **minimal** (only non-loopback traffic)
  - `xdp_tx` or `xdp_redirect` counts loopback forwarding
- 

## Troubleshooting

### N9 Traffic Going to Network Instead of Loopback

**Symptom:** Packets sent to network interface, high latency

**Root Cause:** `n3_address`  $\neq$  `n9_address`

**Solution:**

```
WRONG:
n3_address: "10.0.1.10"
n9_address: "10.0.1.20" # Different IP, no loopback!

CORRECT:
n3_address: "10.0.1.10"
n9_address: "10.0.1.10" # Same IP, enables loopback
```

## Verification:

```
curl http://localhost:8080/api/v1/dataplane_config | jq
```

Should show:

```
{
 "n3_ipv4_address": "10.0.1.10",
 "n9_ipv4_address": "10.0.1.10"
}
```

---

## PDR Not Found After Loopback

**Symptom:** Logs show `[n9-loopback] no PDR for destination TEID`

**Root Cause:** PGWU session not created or TEID mismatch

### Diagnosis:

#### 1. Check PFCP Sessions:

```
curl http://localhost:8080/api/v1/sessions | jq '.sessions[] |
select(.uplink_teid == 200)'
```

#### 2. Verify FAR Configuration:

```
curl http://localhost:8080/api/v1/far_map | jq '.[[] |
select(.teid == 200)'
```

**Solution:** Ensure PGWU-C creates session with matching TEID that SGWU-C uses for N9 forwarding

---

## High CPU Usage

**Symptom:** CPU usage higher than expected

**Root Cause:** eBPF program processing packets multiple times or excessive map lookups

**Diagnosis:**

```
Check eBPF map access patterns
sudo bpftool map dump name pdr_map_teid_ip4 | wc -l
sudo bpftool map dump name far_map | wc -l
```

**Solution:**

- Increase `max_sessions` if map is full (causes lookup failures)
  - Verify QER rate limiting is not causing drops and retransmits
  - Check for excessive packet buffering
- 

## Packet Loss During Handover

**Symptom:** Packets dropped during eNodeB handover

**Root Cause:** Buffering not configured or insufficient buffer limits

**Configuration:**

```
buffer_port: 22152
buffer_max_packets: 20000 # Increase for high-mobility
networks
buffer_max_total: 100000
buffer_packet_ttl: 30 # Adjust based on handover time
```

### Verification:

```
curl http://localhost:8080/api/v1/upf_buffer_info | jq
```

## Benefits of N9 Loopback

### Performance

Metric	Two Instances	Single Instance (N9 Loopback)	Improvement
Latency	1-5 ms	< 1 $\mu$ s	1000x faster
Throughput	Limited by network	Limited by CPU/memory	2-3x higher
CPU Usage	2x XDP passes + network stack	1x XDP pass	40-50% reduction
Packet Loss	Risk during network congestion	Zero (in-memory)	Eliminated

### Operational

- **Simplified Deployment:** Single OmniUPF instance instead of two
- **Reduced Infrastructure:** Half the servers, network ports, IP addresses

- **Lower Complexity:** Single configuration, single monitoring endpoint
- **Cost Savings:** Reduced hardware, power, cooling, maintenance
- **Easier Troubleshooting:** Single packet trace, single eBPF debug output

## Use Cases

### Ideal For:

- **Edge Computing:** Minimize latency for local breakout
- **Small/Medium Deployments:** < 100K subscribers
- **Lab/Testing:** Full EPC user plane on single VM
- **Cost-Constrained:** Limited hardware budget

### Not Recommended For:

- **Geographic Redundancy:** SGWU and PGWU in different data centers
  - **Massive Scale:** > 1M subscribers (consider horizontal scaling)
  - **Regulatory Requirements:** Mandated separation of SGW and PGW
-

# Comparison with Other Deployment Modes

## Single Instance (N9 Loopback) vs. Separated Instances

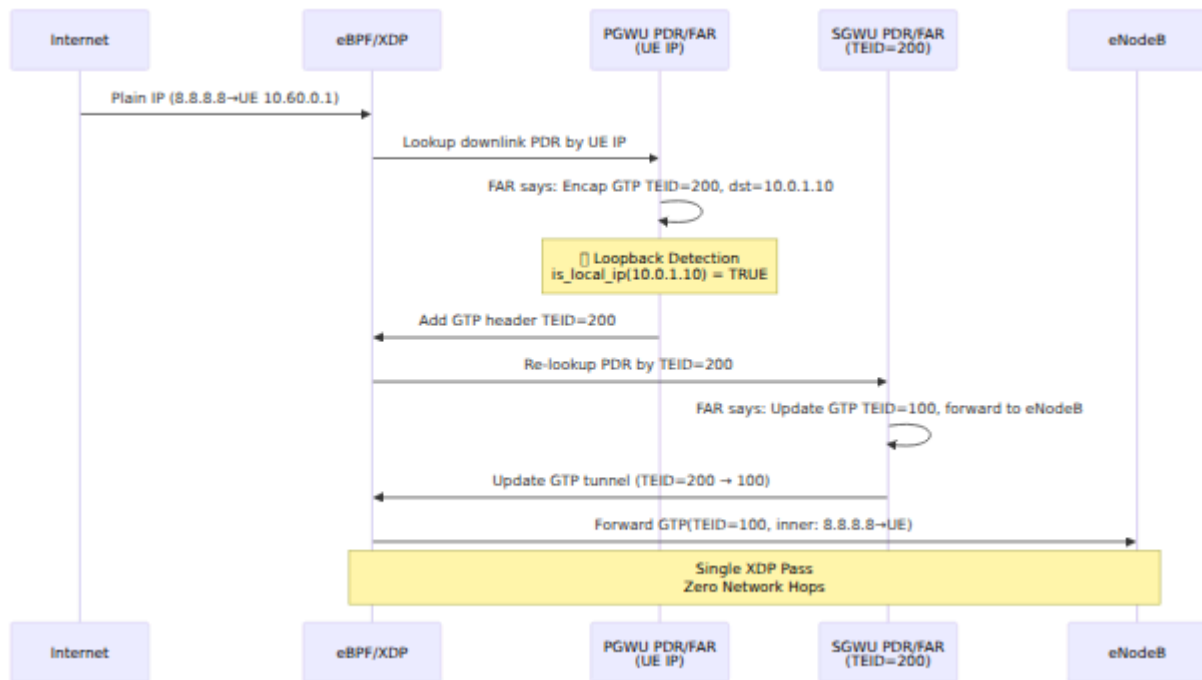

## Summary

N9 Loopback enables **carrier-grade 4G EPC user plane on a single OmniUPF instance** by processing SGWU→PGWU traffic entirely in eBPF without network hops. This provides:

- **Sub-microsecond latency** for inter-gateway forwarding
- **40-50% CPU reduction** compared to separated instances
- **Simplified operations** - single instance, config, monitoring
- **Lower cost** - half the infrastructure
- **Full 3GPP compliance** - standard PFCP, GTP-U protocols

**Configuration is automatic** when `n3_address == n9_address` - no special flags or settings required. OmniUPF's eBPF datapath detects loopback conditions and processes packets inline.

For more information:

- **Configuration:** [CONFIGURATION.md](#)
- **Architecture:** [ARCHITECTURE.md](#)
- **Metrics Reference:** [METRICS.md](#)
- **Monitoring:** [MONITORING.md](#)
- **Operations:** [OPERATIONS.md](#)
- **Troubleshooting:** [TROUBLESHOOTING.md](#)

# PFCP Cause Codes Reference

## Overview

PFCP (Packet Forwarding Control Protocol) uses cause codes in response messages to indicate the outcome of requests. This document describes the cause codes implemented in OmniUPF and when they occur during PFCP message processing.

All cause codes conform to **3GPP TS 129.244** specifications and are returned in PFCP response messages to indicate success, failure, or specific error conditions.

## Monitoring Cause Codes

OmniUPF tracks PFCP message outcomes using Prometheus metrics. Each PFCP response includes a cause code that's recorded in:

```
upf_pfcpx_errors{message_name="...", cause_code="...", peer_address="..."}
```

This enables monitoring of:

- **Success rates** per message type and control plane node
- **Error patterns** indicating misconfigurations or protocol issues
- **Association health** based on rejection rates

See [Metrics Reference](#) for complete PFCP metrics documentation.

# Cause Code Categories

## Success Codes

Code	Name	When It Occurs
1	<b>RequestAccepted</b>	Request successfully processed. All mandatory IEs present and valid. Rules created/modified/deleted successfully.

## Client Error Codes

Code	Name	When It Occurs
64	<b>RequestRejected</b>	General rejection for unspecified errors. Used when no specific cause code applies.
65	<b>SessionContextNotFound</b>	Session Modification or Deletion requested for unknown SEID. The specified session does not exist on this UPF.
66	<b>MandatoryIEMissing</b>	Required Information Element absent. Examples: NodeID missing in Association Setup, F-SEID missing in Session Establishment, RecoveryTimeStamp missing.
67	<b>ConditionalIEMissing</b>	Conditionally required IE missing based on other IEs present. Used when IEs depend on each other's presence.
69	<b>MandatoryIEIncorrect</b>	Required IE present but contains invalid data. Examples: Unparseable NodeID format, invalid RecoveryTimeStamp value, malformed F-SEID.

Code	Name	When It Occurs
72	<b>NoEstablishedPFCPAssociation</b>	Session operation attempted without active association. Must establish PFCP association before creating sessions.
73	<b>RuleCreationModificationFailure</b>	Error applying PDR, FAR, QER, or URR rules to eBPF datapath. Possible causes: eBPF map capacity exhausted, invalid rule parameters, resource allocation failure.

## Server/Resource Error Codes

Code	Name	When It Occurs
74	<b>PFCEntityInCongestion</b>	UPF experiencing high load or resource exhaustion. Temporarily unable to process requests.
75	<b>NoResourcesAvailable</b>	Insufficient resources to fulfill request. Examples: eBPF map capacity exhausted, memory allocation failure, TEID pool depleted.
77	<b>SystemFailure</b>	Critical internal error preventing request processing. Examples: eBPF program failure, kernel interface error, database corruption.

# Unsupported Feature Codes

Code	Name	When It Occurs
68	<b>InvalidLength</b>	IE length field doesn't match actual data length. Currently unused in OmniUPF.
70	<b>InvalidForwardingPolicy</b>	Forwarding policy not supported by UPF. Currently unused in OmniUPF.
71	<b>InvalidFTEIDAllocationOption</b>	F-TEID allocation option not supported. Currently unused in OmniUPF.
76	<b>ServiceNotSupported</b>	Requested service or feature not implemented. Currently unused in OmniUPF.
78	<b>RedirectionRequested</b>	UPF requests redirection to another UPF instance. Currently unused in OmniUPF.

## Common Scenarios and Causes

### Association Setup Failures

#### Scenario: Missing NodeID

SMF → UPF: Association Setup Request (no NodeID)  
UPF → SMF: Association Setup Response (Cause: MandatoryIEMissing)

**Resolution:** Ensure SMF includes NodeID IE in all Association Setup Requests.

## Scenario: Invalid NodeID Format

```
SMF → UPF: Association Setup Request (NodeID="invalid")
UPF → SMF: Association Setup Response (Cause:
MandatoryIEIncorrect)
```

**Resolution:** NodeID must be valid FQDN or IPv4/IPv6 address.

## Scenario: Missing Recovery Timestamp

```
SMF → UPF: Association Setup Request (no RecoveryTimeStamp)
UPF → SMF: Association Setup Response (Cause: MandatoryIEMissing)
```

**Resolution:** Include RecoveryTimeStamp in Association Setup Request.

# Session Establishment Failures

## Scenario: No Association Established

```
SMF → UPF: Session Establishment Request
UPF → SMF: Session Establishment Response (Cause:
NoEstablishedPFCPAssociation)
```

**Resolution:** Establish PFCP association before creating sessions.

## Scenario: Rule Creation Failure

```
SMF → UPF: Session Establishment Request
UPF processes FARs, QERs, URRs successfully
UPF fails to create PDR (eBPF map full)
UPF → SMF: Session Establishment Response (Cause:
RuleCreationModificationFailure)
```

**Resolution:**

- Check eBPF map capacity (see [Capacity Monitoring](#))

- Increase map sizes in UPF configuration
- Reduce active session count

### **Scenario: Missing F-SEID**

```
SMF → UPF: Session Establishment Request (no CP F-SEID)
UPF → SMF: Session Establishment Response (Cause:
MandatoryIEMissing)
```

**Resolution:** Include CP F-SEID in Session Establishment Request.

## **Session Modification Failures**

### **Scenario: Unknown SEID**

```
SMF → UPF: Session Modification Request (SEID=12345)
UPF has no session with SEID 12345
UPF → SMF: Session Modification Response (Cause:
SessionContextNotFound)
```

### **Resolution:**

- Verify SEID matches value from Session Establishment Response
- Check if session was already deleted
- Ensure using correct UPF instance (N9 loopback scenarios)

## **Session Deletion Failures**

### **Scenario: Unknown SEID**

```
SMF → UPF: Session Deletion Request (SEID=67890)
UPF has no session with SEID 67890
UPF → SMF: Session Deletion Response (Cause:
SessionContextNotFound)
```

**Resolution:** SEID may have already been deleted or never existed.

# Troubleshooting with Cause Codes

## Using Prometheus Metrics

Query Prometheus to identify error patterns:

```
Error rate by cause code
rate(upf_pfcpx_errors{cause_code!="RequestAccepted"}[5m])

Top rejection causes
topk(5, sum by (cause_code) (upf_pfcpx_errors))

Errors by SMF peer
sum by (peer_address, cause_code)
(upf_pfcpx_errors{cause_code!="RequestAccepted"})

Session establishment failures
upf_pfcpx_errors{message_name="SessionEstablishmentRequest",
cause_code!="RequestAccepted"}
```

## Using Web UI

Navigate to **Sessions** page to view:

- Active session count per control plane node
- Session establishment success/failure rates
- Recent session errors

Navigate to **Capacity** page to diagnose:

- eBPF map utilization (RuleCreationModificationFailure root cause)
- Resource exhaustion indicators

See [Web UI Guide](#) for detailed monitoring instructions.

## Common Debugging Steps

**High MandatoryIEMissing Rate:**

1. Check SMF configuration for required IEs
2. Verify PFCP library version compatibility
3. Review SMF logs for IE construction errors

#### **Frequent RuleCreationModificationFailure:**

1. Check eBPF map capacity: `GET /api/v1/map_info`
2. Monitor map usage: `upf_ebpf_map_used / upf_ebpf_map_capacity`
3. Increase map sizes in configuration if > 70% utilized
4. See [Capacity Planning](#)

#### **NoEstablishedPFCPAssociation Errors:**

1. Verify association exists: `GET /api/v1/pfcp_associations`
2. Check heartbeat timeout configuration
3. Review association setup logs
4. Ensure SMF and UPF can reach each other

#### **SessionContextNotFound on Modification:**

1. Verify SEID from session establishment response
2. Check if session was deleted
3. For N9 loopback: Ensure using correct UPF endpoint
4. Query active sessions: `GET /api/v1/pfcp_sessions`

# **Cause Code Impact on Operations**

## **Session Lifecycle**



Association Phase

Association Setup Request

Response (Cause: RequestAccepted)

[Missing NodeID]

Response (Cause: MandatoryIEMissing)

[Invalid NodeID]

Response (Cause: MandatoryIEIncorrect)

Session Establishment Phase

Session Establishment Request

alt [No Association]

Response (Cause: NoEstablishedPFCPSAssociation)

[eBPF Map Full]

Response (Cause: RuleCreationModificationFailure)

[Success]

Response (Cause: RequestAccepted)

Session created, rules active

Session Modification Phase

Session Modification Request

alt [Unknown SEID]

Response (Cause: SessionContextNotFound)

[Success]

Response (Cause: RequestAccepted)

 SMF UPF

## Metrics and Alerting

### Recommended Alerts:

```
Critical: High rejection rate
- alert: PfcphighRejectionRate
 expr: |
 rate(upf_pfcpx_errors{cause_code!="RequestAccepted"}[5m]) > 0.1
 annotations:
 summary: "High PFCP rejection rate: {{ $value }}/s"

Warning: Capacity issues
- alert: PfcpruleCreationFailures
 expr: |

rate(upf_pfcpx_errors{cause_code="RuleCreationModificationFailure"}
[5m]) > 0
 annotations:
 summary: "PFCP rule creation failures detected"

Warning: Association issues
- alert: PfcpruleNoAssociation
 expr: |

rate(upf_pfcpx_errors{cause_code="NoEstablishedPFCPAssociation"}
[5m]) > 0
 annotations:
 summary: "PFCP sessions attempted without association"
```

## 3GPP Standards Compliance

OmniUPF implements cause codes according to:

- **3GPP TS 129.244 v16.4.0** - PFCP specification
- **Section 8.2.1** - Cause IE definition
- **Section 8.19** - Cause values table

# Related Documentation

- **PFCP Protocol Integration** - PFCP architecture and message handling
- **Metrics Reference** - upf\_pfcpx\_errors metric documentation
- **Monitoring Guide** - Capacity monitoring and alerting
- **Troubleshooting Guide** - PFCP association and session issues
- **Web UI Guide** - Sessions and associations monitoring

# UE Route Management

## Related Documentation:

- [API Documentation](#) - Complete API reference including route management endpoints
- [Operations Guide](#) - Web UI operations and monitoring

## Overview

The UPF (User Plane Function) integrates with **FRR (Free Range Routing)** to dynamically manage User Equipment (UE) IP routes. This integration ensures that as UE sessions are established or terminated, the routing infrastructure automatically adapts to reflect the current network topology.

## What is FRR?

**FRR (Free Range Routing)** is a robust, open-source routing protocol suite for Linux and Unix platforms. It implements various routing protocols including BGP, OSPF, RIP, and others. In our deployment, FRR acts as the routing daemon that maintains the kernel routing table and can redistribute routes to other network elements.

## Architecture



# How Route Synchronization Works

## Route Lifecycle

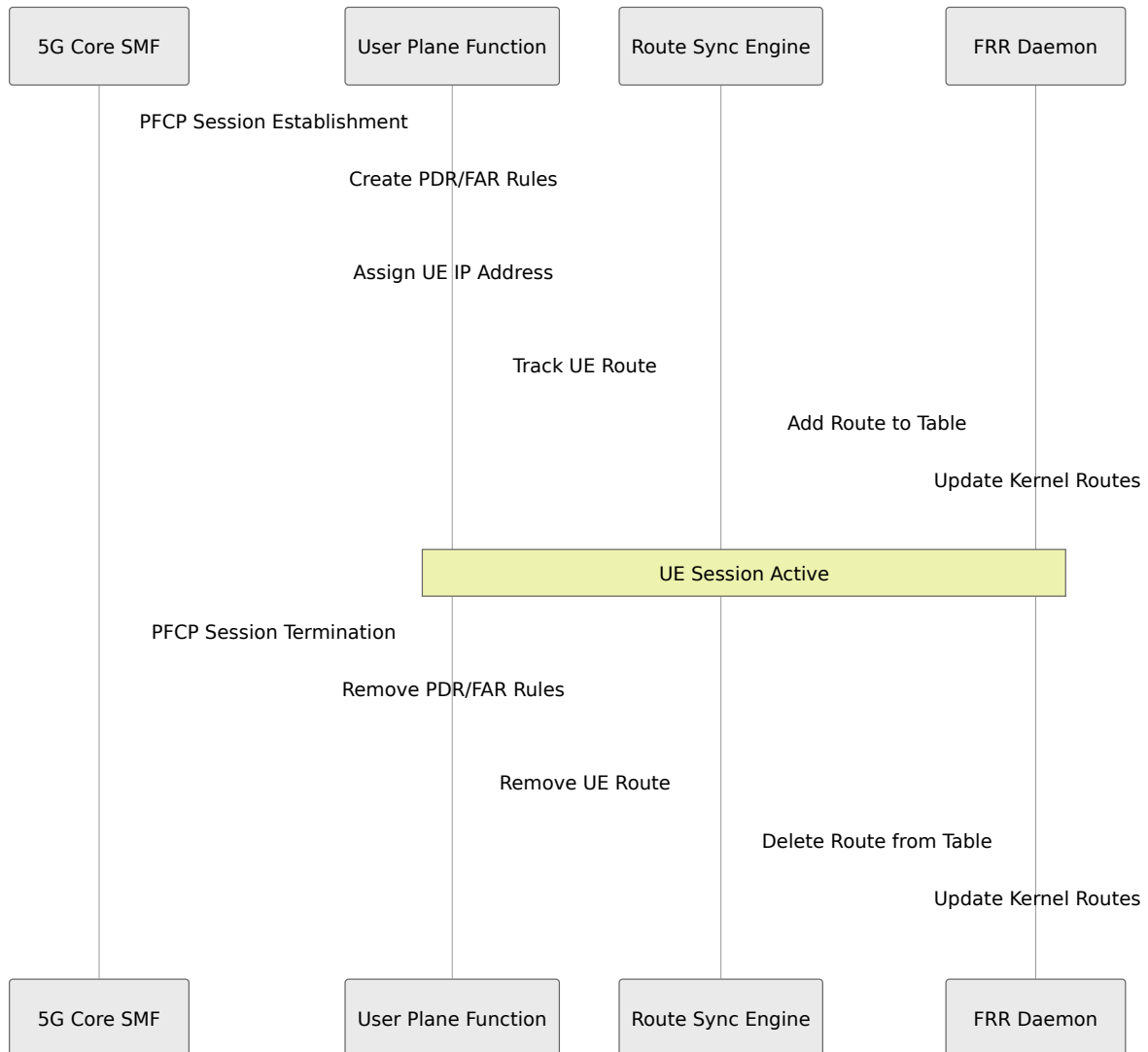

## Automatic Synchronization

The UPF maintains an internal registry of all active UE IP addresses. When enabled, the route synchronization system:

- 1. Monitors UE Sessions:** Tracks all active PFCP sessions and their associated UE IP addresses
- 2. Maintains Route List:** Keeps an up-to-date list of routes that need to be in the routing table

3. **Syncs to FRR:** Automatically pushes route updates to the FRR daemon via its API
4. **Handles Failures:** Tracks sync status (synced/failed) for each route and retries as needed

## FRR Setup

### Configuration

FRR is deployed and configured using **Ansible templates** to establish the base routing parameters. You define the FRR configuration once as a **Jinja2 template** in your Ansible playbook, and Ansible automatically propagates it to all your UPF instances during deployment.

A typical FRR Jinja2 configuration template includes:

```

frr version 7.2.1
frr defaults traditional
hostname pgw02
log syslog informational
service integrated-vtysh-config
!
ip route {{ hostvars[inventory_hostname]['ansible_default_ipv4']
['gateway'] }}/32 {{ ansible_default_ipv4['interface'] }}
!
interface {{ ansible_default_ipv4['interface'] }}
 ip address ospf router-id {{hostvars[inventory_hostname]
['ansible_host']}}
 ip ospf authentication null
!
router ospf
 ospf router-id {{hostvars[inventory_hostname]['ansible_host']}}
 redistribute static
 network {{ hostvars[inventory_hostname]['ansible_default_ipv4']
['network'] }}/{{ mask_cidr }} area 0
 area 0 authentication message-digest
!
line vty
!
end

```

## Deployment Model:

1. **Define Once:** Create the FRR Jinja2 template in your Ansible role (e.g., `roles/frr/templates/frr.conf.j2`)
2. **Configure Parameters:** Set variables in your Ansible inventory for each UPF host
3. **Deploy Everywhere:** Run the Ansible playbook to deploy FRR configuration to all UPF nodes
4. **Automatic Customization:** Ansible uses host-specific variables (IP addresses, router IDs, etc.) to customize each UPF's FRR configuration

## Customizable Parameters in the Jinja2 template:

- **OSPF parameters:** Router ID, area configuration, authentication methods, network advertisements

- **BGP configuration:** ASN, neighbor relationships, route policies, communities
- **Route redistribution:** Which routes to redistribute (e.g., `redistribute static` for UE routes)
- **Route filtering:** Route maps, prefix lists, access lists
- **Interface settings:** OSPF/BGP interface parameters

**UPF Integration:** Once the base FRR configuration is deployed to each UPF instance, the UPF dynamically adds UE IP addresses as **host routes** (/32 for IPv4, /128 for IPv6) via the FRR vtysh interface based on active PFCP sessions. These routes are then:

1. **Added as FRR static routes** by the UPF route sync engine (via vtysh)
2. **Picked up by FRR** via the `redistribute static` directive
3. **Advertised to routing protocols** (OSPF, BGP) according to your FRR configuration
4. **Propagated to the network** so that UE traffic can be routed to this UPF instance

**Important:** The UPF adds routes through FRR's vtysh interface, making them FRR static routes (not kernel routes). You must use `redistribute static` in your OSPF/BGP configuration, not `redistribute kernel`.

### Key Points:

- **Set Once, Deploy Everywhere:** Define the FRR Jinja2 template once in Ansible, and it's automatically deployed to all UPF instances
- **Ansible handles static config:** The Jinja2 template sets up all routing protocol parameters (OSPF areas, BGP neighbors, authentication, route policies, etc.)
- **UPF handles dynamic routes:** Each UPF instance dynamically manages only the UE IP /32 routes based on its active PFCP sessions
- **Automatic route advertisement:** FRR on each UPF automatically redistributes the local UE routes according to your configured policies
- **Centralized management:** Update the Ansible template and re-run the playbook to change routing configuration across all UPFs simultaneously

# Route Advertisement

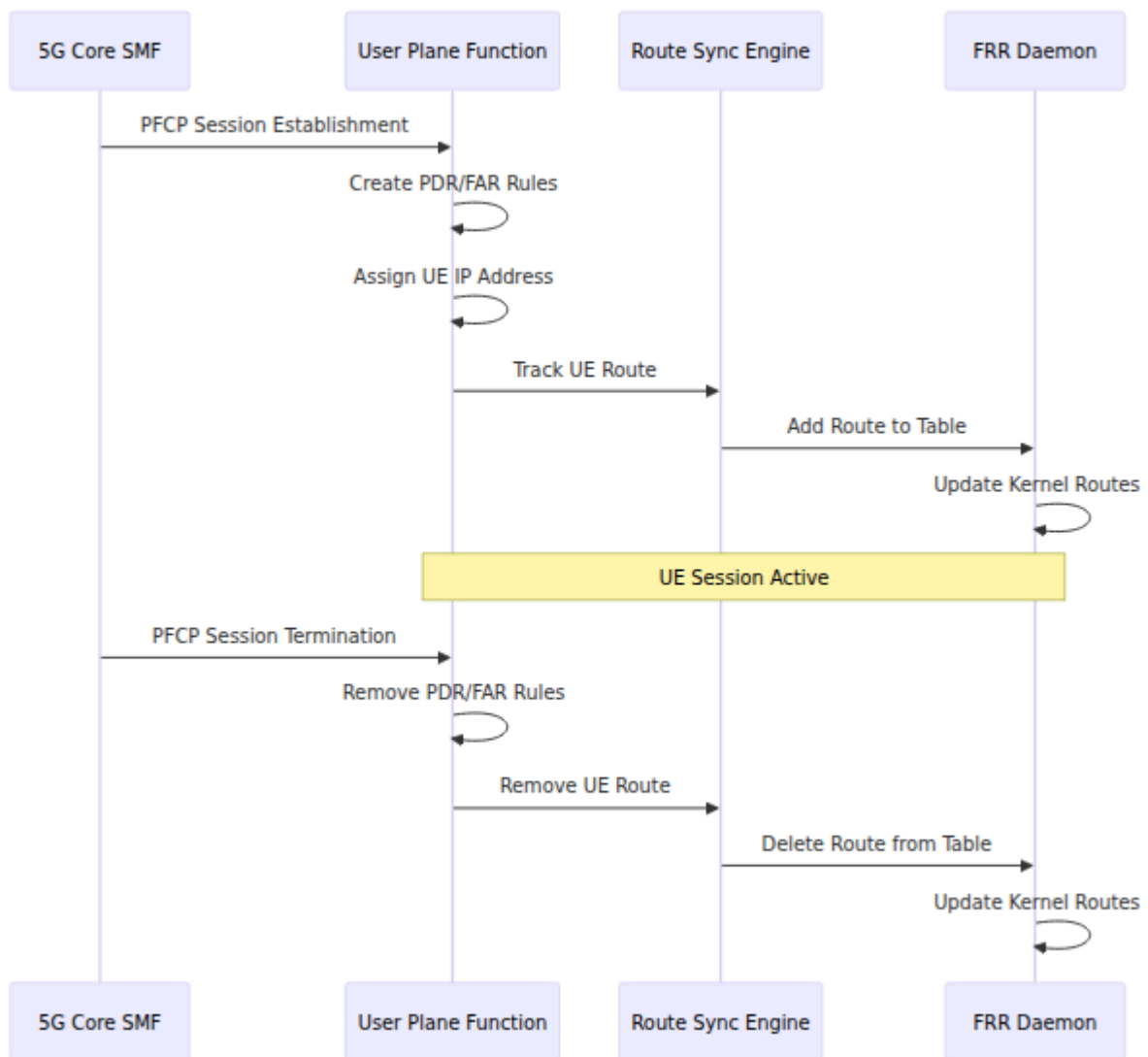

# Monitoring and Management

## Web UI Integration

The UPF Control Panel provides a **Routes** page that displays:

- **Route Status:** Whether route synchronization is enabled or disabled
- **Total Routes:** Number of UE IP addresses being tracked
- **Sync Statistics:** Count of successfully synced routes and any failures
- **Active Routes:** Real-time list of all UE IP addresses currently in the routing table

- **OSPF Neighbors:** Live status of OSPF adjacencies with neighbor details
- **BGP Peers:** BGP session status and prefix statistics (when configured)
- **OSPF Redistributed Routes:** Complete view of external LSAs showing how UE routes are advertised

*The Routes page provides comprehensive visibility into UE route synchronization, routing protocol neighbors, and redistributed route advertisements.*

## **Manual Sync Operation**

Administrators can trigger a manual route synchronization through the web UI using the **Sync Routes** button. This operation:

1. Re-reads the current list of active UE sessions from the UPF
2. Compares with FRR's routing table
3. Adds any missing routes
4. Removes any stale routes

## 5. Returns updated sync statistics

# Route Flow

UE Connects

PFCP Session Created

PDR/FAR Rules Installed

UE IP Tracked in Route List

Route Sync Enabled?

Yes

No

Push Route to FRR

Route Tracked Only

Route Active in Network

UE Traffic Flows

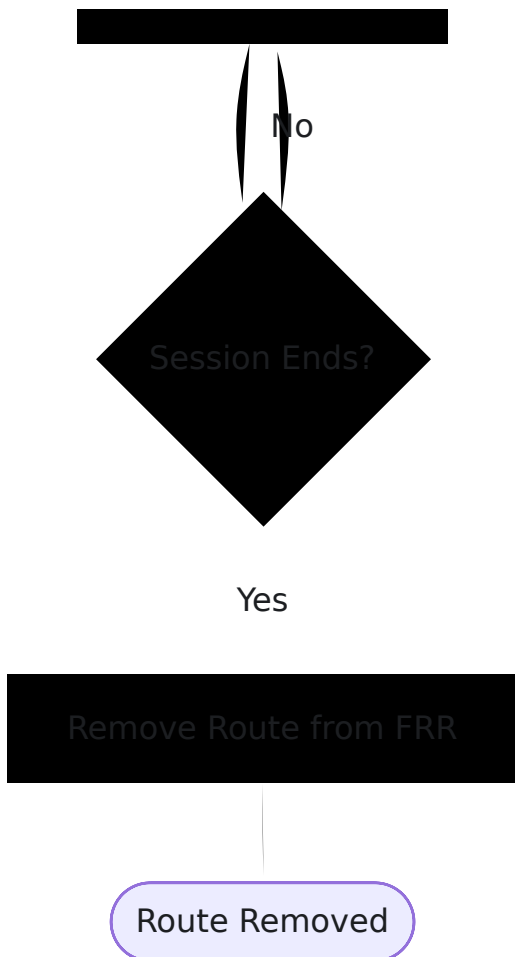

## Benefits

- **Zero Touch Provisioning:** Routes are automatically managed without manual intervention
- **Dynamic Adaptation:** Network routing adapts in real-time to UE mobility and session changes
- **Scalability:** Supports thousands of concurrent UE routes
- **Resilience:** Failed sync operations are tracked and can be retried
- **Visibility:** Full visibility into route status through the web UI

## Technical Details

### API Endpoints

The UPF exposes the following route management endpoints:

- `GET /api/v1/routes` - List all tracked UE routes without syncing
- `POST /api/v1/routes/sync` - Sync routes to FRR and return updated list
- `GET /api/v1/route_stats` - Get detailed routing statistics
- `GET /api/v1/routing/sessions` - Get routing protocol sessions (OSPF neighbors, BGP peers)
- `GET /api/v1/ospf/database/external` - Get OSPF AS-External LSA database (redistributed routes)

**See Also:** [API Documentation - Route Management](#) for complete endpoint details and examples

## Route Format

Routes are stored and managed as simple IP addresses (e.g., `100.64.18.5`). The routing daemon handles the full route entry details including:

- Destination prefix/mask
- Gateway/next-hop
- Interface binding
- Metric and administrative distance

## IPv6 Support

The route manager supports both IPv4 and IPv6 UE addresses:

Address Type	Prefix Length	Example
IPv4	/32	<code>100.64.18.5/32</code>
IPv6	/128	<code>2001:db8::1/128</code>

For IPv6, ensure your FRR configuration includes the appropriate OSPFv3 or BGP IPv6 redistribution:

```
router ospf6
 redistribute static
```

or for BGP:

```
router bgp <asn>
 address-family ipv6 unicast
 redistribute static
```

# FRR Verification

## OSPF External LSA Database

You can verify that UE routes are being properly redistributed into OSPF by examining the FRR OSPF Link State Database. External LSAs (Type 5) show routes that have been injected into OSPF from external sources.

*FRR OSPF database showing external LSAs including UE route 100.64.18.5/32 being advertised as an E2 (External Type 2) route.*

In the example above, you can see:

- **Network LSA (10.98.0.20):** The UPF's own network advertisement
- **Router LSA (192.168.1.1):** OSPF router advertisement
- **External LSAs:** Including the UE route 100.64.18.5 redistributed into OSPF with metric type E2 (External Type 2)

This verification confirms that:

1. The UPF is successfully tracking the UE IP address
2. The route sync engine has pushed the route to FRR
3. FRR has redistributed the route into OSPF
4. OSPF neighbors are receiving the route advertisements

# Rules Management Guide

## Table of Contents

1. [Overview](#)
2. [Packet Detection Rules \(PDR\)](#)
3. [Forwarding Action Rules \(FAR\)](#)
4. [QoS Enforcement Rules \(QER\)](#)
5. [Usage Reporting Rules \(URR\)](#)
6. [Rule Relationships](#)
7. [Common Operations](#)
8. [Troubleshooting](#)

## Overview

OmniUPF uses a set of interconnected rules to classify, forward, shape, and track user plane traffic. These rules are installed by the SMF via PFCP and stored in eBPF maps for high-performance packet processing. Understanding these rules and their relationships is critical for operating and troubleshooting the UPF.

# Rule Types

Rule Type	Purpose	Key Field	Installed By
<b>PDR</b> (Packet Detection Rule)	Classify packets into flows	TEID or UE IP	SMF via PFCP Session Establishment/Modification
<b>FAR</b> (Forwarding Action Rule)	Determine forwarding action	FAR ID	SMF via PFCP Session Establishment/Modification
<b>QER</b> (QoS Enforcement Rule)	Apply bandwidth limits and marking	QER ID	SMF via PFCP Session Establishment/Modification
<b>URR</b> (Usage Reporting Rule)	Track data volumes for charging	URR ID	SMF via PFCP Session Establishment/Modification

## Rule Processing Flow

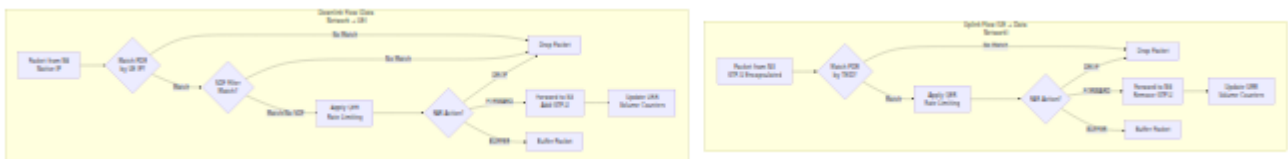

# Packet Detection Rules (PDR)

## Purpose

PDRs classify incoming packets into traffic flows. They are the entry point for all packet processing in the UPF.

# PDR Structure

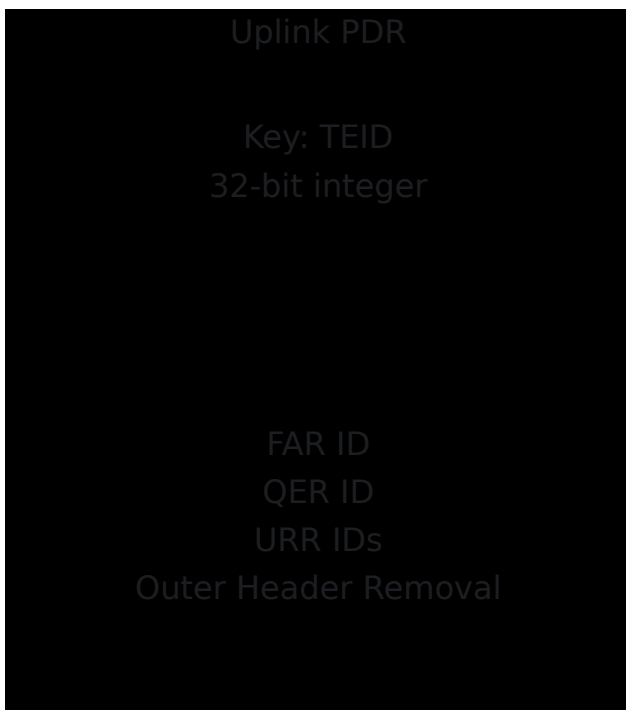
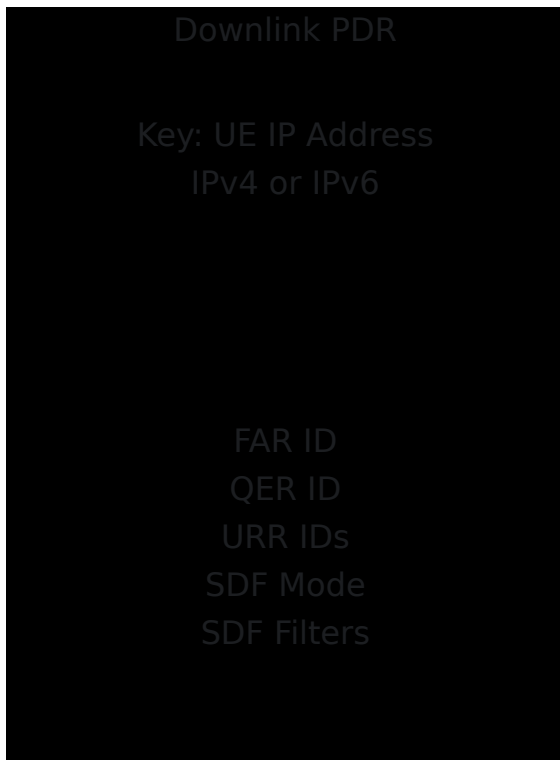

## Uplink PDRs

Uplink PDRs match packets arriving on the N3 interface from the RAN.

**Key Field:** TEID (Tunnel Endpoint Identifier)

- 32-bit unsigned integer
- Assigned by SMF and signaled to gNB
- Unique per UE traffic flow

**Value Fields:**

- **FAR ID:** Reference to forwarding action rule
- **QER ID:** Reference to QoS enforcement rule (optional)
- **URR IDs:** List of usage reporting rules (optional)
- **Outer Header Removal:** Flag to remove GTP-U encapsulation

**Lookup Process:**

1. Extract TEID from GTP-U header
2. Hash lookup in `uplink_pdr_map` eBPF map
3. If match found, retrieve FAR ID, QER ID, and URR IDs
4. If no match, drop packet

**Example:**

```
TEID: 5678
FAR ID: 2
QER ID: 1
Outer Header Removal: False
SDF Mode: No SDF
```

## Downlink PDRs

Downlink PDRs match packets arriving on the N6 interface from the data network.

**Key Field:** UE IP Address

- IPv4 address (32-bit) or IPv6 address (128-bit)
- Assigned by SMF during PDU session establishment
- Unique per UE

**Value Fields:**

- **FAR ID:** Reference to forwarding action rule
- **QER ID:** Reference to QoS enforcement rule (optional)
- **URR IDs:** List of usage reporting rules (optional)
- **SDF Mode:** Service Data Flow filter mode
  - **No SDF:** No filtering, all traffic matches

- **SDF Only**: Only SDF-matched traffic is forwarded
- **SDF + Default**: SDF-matched traffic uses specific rules, other traffic uses default FAR
- **SDF Filters**: Application-specific filters (ports, protocols, IP ranges)

### Lookup Process:

1. Extract destination IP from packet header
2. Hash lookup in `downlink_pdr_map` (IPv4) or `downlink_pdr_map_ip6` (IPv6)
3. If match found, check SDF filters (if configured)
4. Retrieve FAR ID, QER ID, and URR IDs
5. If no match, drop packet

### Example:

```
UE IP: 10.45.0.1
FAR ID: 1
QER ID: 1
Outer Header Removal: False
SDF Mode: No SDF
```

## SDF Filters (Service Data Flow)

SDF filters provide application-specific traffic classification within a PDR.

### Use Cases:

- Differentiate YouTube traffic from web browsing
- Apply different QoS to VoIP vs. best-effort data
- Route specific applications through different network paths

### Filter Criteria:

- **Protocol:** TCP, UDP, ICMP
- **Port Range:** Destination ports (e.g., 443 for HTTPS, 5060 for SIP)
- **IP Address Range:** Specific destination networks
- **Flow Description:** 3GPP-defined flow templates

### Example SDF Configuration:

PDR ID: 10

UE IP: 10.45.0.1

SDF Mode: SDF Only

SDF Filters:

- Protocol: UDP, Ports: 5060-5061 → FAR ID 5 (VoIP FAR)
- Protocol: TCP, Port: 443 → FAR ID 1 (Default FAR)

# Forwarding Action Rules (FAR)

## Purpose

FARs determine what to do with packets that match a PDR. They define forwarding actions, GTP-U encapsulation parameters, and destination endpoints.

# FAR Structure

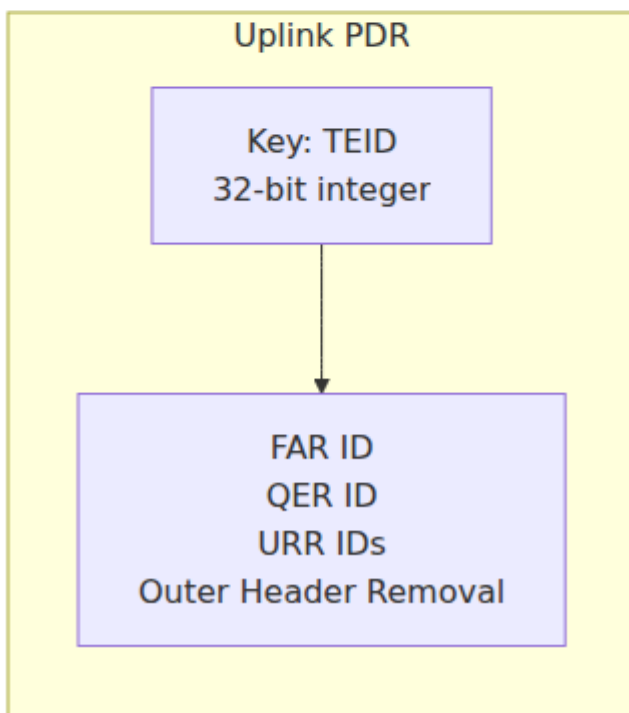
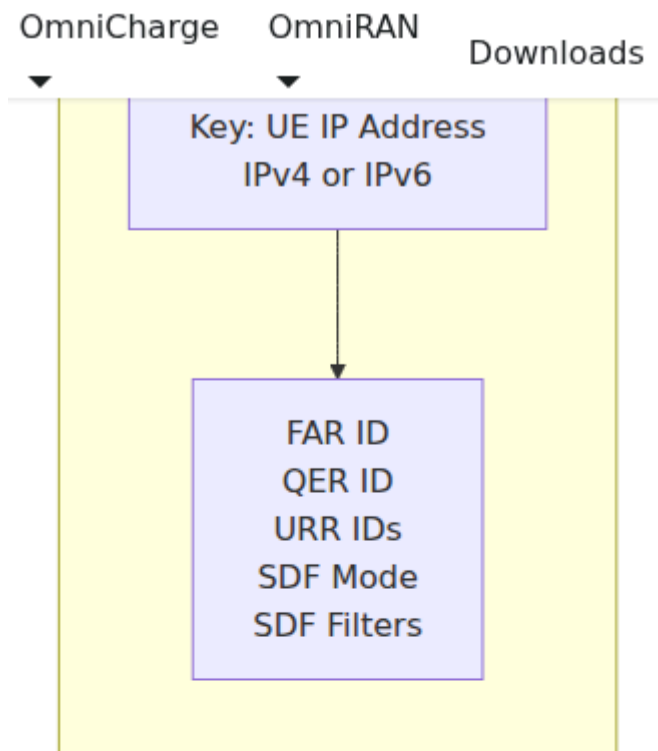

## Action Flags

FAR actions are bitwise flags that can be combined:

Flag	Bit	Value	Description
<b>FORWARD</b>	1	2	Forward packet to destination
<b>BUFFER</b>	2	4	Store packet in buffer
<b>DROP</b>	0	1	Discard packet
<b>NOTIFY</b>	3	8	Send notification to control plane
<b>DUPLICATE</b>	4	16	Duplicate packet to multiple destinations

### Common Action Combinations:

- Action: 2 (FORWARD) - Normal forwarding (most common)
- Action: 6 (FORWARD + BUFFER) - Forward and buffer during handover
- Action: 4 (BUFFER) - Buffer only (during path switch)
- Action: 1 (DROP) - Drop packet (rare, usually for policy enforcement)

## Buffering Control

The BUFFER flag (bit 2) controls packet buffering during mobility events. Buffering is a critical UPF feature that prevents packet loss during UE state transitions.

### When Buffering is Used

**Idle-to-Connected Transition:** When downlink packets arrive for a UE in IDLE state (not connected to gNB), the UPF:

1. Buffers the packets
2. Sends a Downlink Data Notification (DLDR) to the SMF
3. SMF pages the UE to wake up and connect
4. Once connected, SMF updates the FAR with FORWARD action
5. UPF flushes buffered packets to the UE

**Handover (Connected-to-Connected):** During gNB-to-gNB handover, the UPF temporarily buffers packets to prevent loss:

1. Old gNB connection is dropped
2. SMF sets FAR action to BUFFER
3. Packets queue during path switch
4. UE connects to new gNB
5. SMF updates FAR with new TEID and FORWARD action
6. UPF flushes packets to new gNB

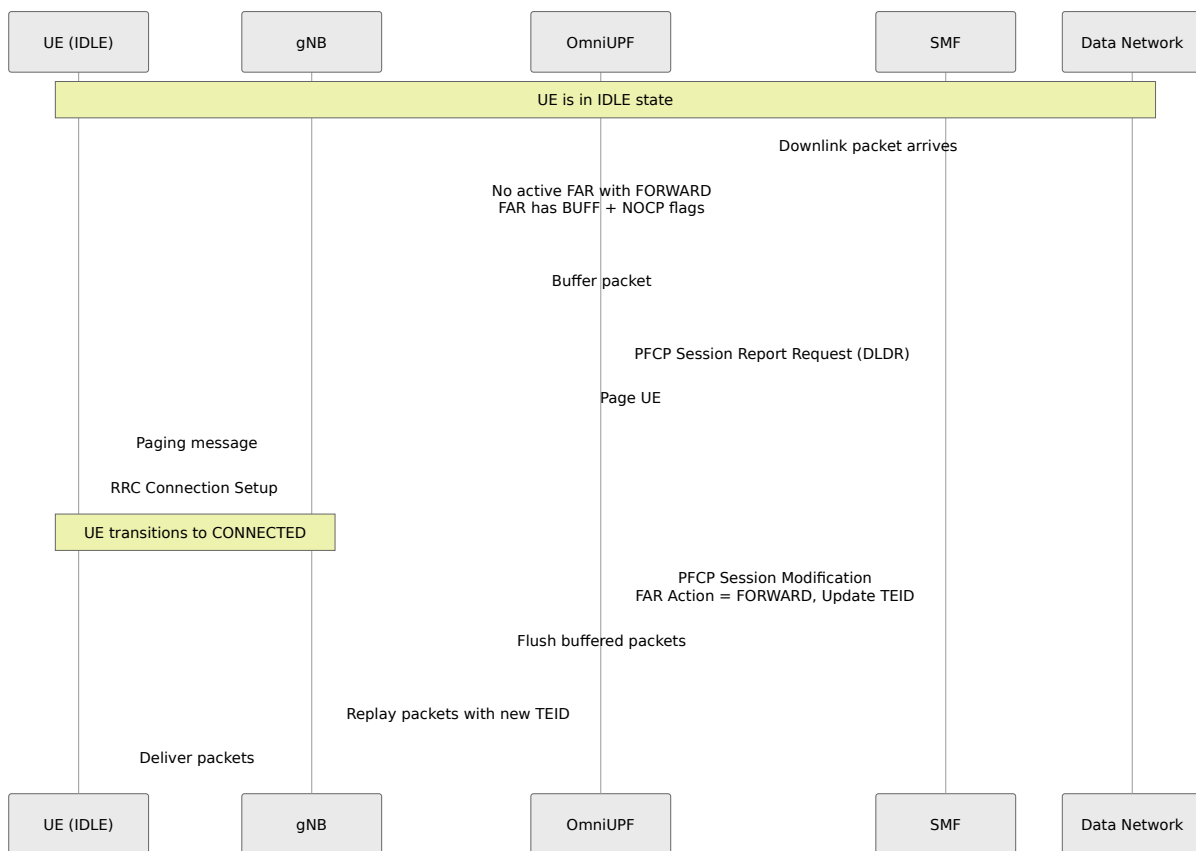

## Buffer Capacity and Limits

### Global Buffer Limits:

- **Max Total Packets:** 100,000 (configurable)
- **Max Total Bytes:** Based on available memory
- **TTL (Time-to-Live):** 60 seconds (configurable)
- **Packets exceeding TTL:** Automatically dropped

### Per-FAR Limits:

- **Max Packets per FAR:** 10,000 (configurable)
- **Purpose:** Prevent a single FAR from exhausting buffer capacity

### **Buffer Overflow Behavior:**

- When global or per-FAR limit reached, new packets are dropped
- Metrics track drops with `reason="global_limit"` or `reason="far_limit"`
- Oldest packets are NOT automatically evicted (explicit drop only on TTL expiration)

### **Downlink Data Notification (DLDR)**

When the UPF buffers a packet for an IDLE UE, it sends a PFCP Session Report Request to the SMF:

#### **DLDR Contents:**

- **Report Type:** Downlink Data Report (DLDR)
- **FAR ID:** The FAR that triggered buffering
- **Downlink Data Service Information:** Optional QFI, Paging Policy Indicator

#### **SMF Actions on DLDR:**

1. Page the UE via AMF → gNB
2. Wait for UE to establish RRC connection
3. Send PFCP Session Modification Request to update FAR
4. FAR action changes from `BUFF+NOCP` to `FORW`
5. UPF flushes buffered packets

#### **Metrics for DLDR:**

- `upf_dldr_sent_total`: Total DLDRs sent
- `upf_dldr_send_errors`: Failed DLDRs
- `upf_buffer_notify_to_flush_duration_seconds`: Latency from DLDR to flush

See [Metrics Reference](#) for complete list.

## Buffering Operations

### Enable Buffering (Set BUFF flag):

- FAR Action `|= 0x04` (set bit 2)
- Example: `Action: 2 (FORW)` → `Action: 6 (FORW+BUFF)`
- Used during handover preparation

### Buffer-Only Mode (BUFF without FORW):

- FAR Action `= 0x04` (BUFF only)
- Packets are buffered but NOT forwarded
- Used for IDLE UE state (pending paging)

### Disable Buffering (Clear BUFF flag):

- FAR Action `&= ~0x04` (clear bit 2)
- Example: `Action: 6 (FORW+BUFF)` → `Action: 2 (FORW)`
- Buffered packets remain until flushed or cleared

### Flush Buffer:

- Replay all buffered packets using **current** FAR rules
- Packets are forwarded with updated TEID/destination
- Buffer is emptied after successful flush
- FAR must have FORW action set

### Clear Buffer:

- Discard all buffered packets without forwarding
- Use when handover fails or session is deleted
- Metrics track with `reason="cleared"`

## Monitoring Buffered Packets

### Buffers Page (Web UI): Navigate to **Buffers** to view:

- Total buffered packets
- Total buffered bytes

- Number of FARs with buffered packets
- Per-FAR packet counts
- Oldest packet timestamp
- Enable/Disable buffering per FAR
- Flush or clear operations

### Key Indicators:

- **Packets > 10 seconds old:** Potential paging delay
- **Packets > 30 seconds old:** Likely paging failure, clear buffer
- **High packet count:** Check for stuck sessions or paging failures

### Prometheus Metrics:

- `upf_buffer_packets_current`: Current buffered packets
- `upf_buffer_bytes_current`: Current buffered bytes
- `upf_buffer_fars_active`: FARs with buffered packets
- `upf_buffer_packets_dropped{reason}`: Dropped packet counts

See [Metrics Reference](#) for complete buffer metrics.

## Common Buffering Scenarios

### Scenario 1: IDLE UE Downlink Data

Initial State:

- UE in IDLE mode (no gNB connection)
- FAR Action: 0x04 (BUFF only)

Data Arrival:

1. DN sends downlink packet
2. UPF matches PDR, applies FAR
3. FAR has BUFF flag → packet buffered
4. UPF sends DLDR to SMF
5. SMF pages UE
6. UE connects to gNB
7. SMF modifies FAR: Action = 0x02 (FORW)
8. UPF flushes buffered packets with new TEID

## Scenario 2: Handover Preparation

### Initial State:

- UE connected to gNB-1 (TEID 1234)
- FAR Action: 0x02 (FORW)

### Handover Process:

1. SMF modifies FAR: Action = 0x06 (FORW+BUFF)
2. Packets forwarded to gNB-1 AND buffered
3. UE switches to gNB-2
4. SMF modifies FAR: TEID = 5678, Action = 0x02 (FORW)
5. UPF flushes buffered packets to gNB-2 with new TEID
6. No packet loss during handover

## Scenario 3: Path Switch

### Initial State:

- UE connected, active data flow

### Path Switch:

1. SMF modifies FAR: Action = 0x04 (BUFF only)
2. All incoming packets buffered (not forwarded)
3. Network reconfigures path
4. SMF modifies FAR: Action = 0x02 (FORW), new destination
5. UPF flushes all buffered packets to new path

## Outer Header Creation

Determines whether GTP-U encapsulation should be added.

### **Uplink FAR** (N3 → N6):

- Outer Header Creation: False
- Action: Remove GTP-U, forward native IP packet

### **Downlink FAR** (N6 → N3):

- Outer Header Creation: True
- Remote IP: gNB IP address (e.g., 200.198.5.10)
- TEID: Tunnel ID for UE traffic
- Action: Add GTP-U header, forward to gNB

## FAR Lookup in Web UI

The Rules Management page provides FAR lookup by ID:

**Steps:**

1. Navigate to Rules → FARs tab
2. Enter FAR ID in search field
3. Click "Lookup" to view FAR details

**Displayed Information:**

- FAR ID
- Action (numeric + decoded flags)
- Buffering status (ON/OFF)
- Outer Header Creation
- Remote IP address (with integer representation)
- TEID
- Transport Level Marking

## **QoS Enforcement Rules (QER)**

### **Purpose**

QERs apply Quality of Service parameters to traffic flows, including bandwidth limits and packet marking.

# QER Structure

## QER Parameters

QFI  
QoS Flow Identifier

Gate Status UL  
Open/Closed

Gate Status DL  
Open/Closed

QER ID  
Unique Identifier

MBR Uplink  
Max Bit Rate

MBR Downlink  
Max Bit Rate

GBR Uplink  
Guaranteed Bit Rate

GBR Downlink  
Guaranteed Bit Rate

# QoS Parameters

## QFI (QoS Flow Identifier):

- 6-bit identifier for 5G QoS flows
- Values 1-9 are standardized (e.g., QFI 9 = default bearer)
- Used for packet marking in 5GC

## Gate Status:

- **Open (0):** Traffic allowed
- **Closed (non-zero):** Traffic blocked

## Maximum Bit Rate (MBR):

- Maximum allowed bandwidth for traffic flow
- Specified in kbps
- **MBR = 0:** No rate limit (unlimited)
- Traffic exceeding MBR is dropped

## Guaranteed Bit Rate (GBR):

- Minimum bandwidth guaranteed for traffic flow
- Specified in kbps
- **GBR = 0:** Best-effort (no guarantee)
- **GBR > 0:** Prioritized flow with guaranteed bandwidth

# QoS Flow Types

## Best-Effort Flows (GBR = 0):

```
QER ID: 1
QFI: 9
MBR Uplink: 100000 kbps (100 Mbps)
MBR Downlink: 100000 kbps (100 Mbps)
GBR Uplink: 0 kbps
GBR Downlink: 0 kbps
```

**Guaranteed Flows (GBR > 0):**

QER ID: 2

QFI: 1

MBR Uplink: 10000 kbps (10 Mbps)

MBR Downlink: 10000 kbps (10 Mbps)

GBR Uplink: 5000 kbps (5 Mbps)

GBR Downlink: 5000 kbps (5 Mbps)

# QoS Enforcement Algorithm

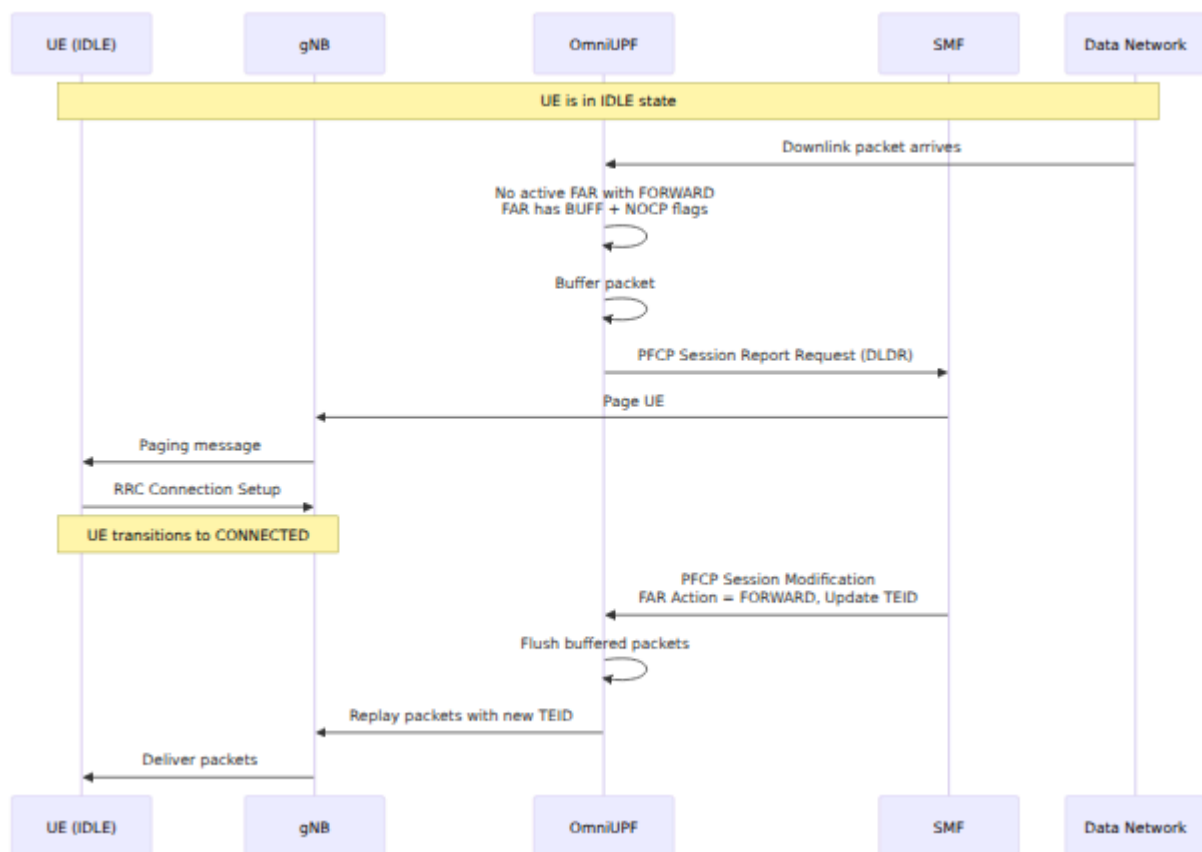

## MBR Enforcement Mechanism

OmniUPF enforces MBR (Maximum Bit Rate) limits using a **sliding window rate limiter** implemented in the eBPF datapath. This algorithm operates at nanosecond precision directly in the XDP layer, ensuring line-rate performance without kernel context switches.

### How It Works

#### Algorithm: Sliding Window Rate Limiting

For each packet, the UPF performs the following checks:

- Gate Status Check:** If gate status is **CLOSED** (non-zero), drop packet immediately
- MBR Check:** If MBR = 0, bypass rate limiting (unlimited bandwidth)
- Transmission Time Calculation:**

```
tx_time = (packet_size_bytes × 8) × (1,000,000,000 ns/sec) /
MBR_kbps
```

4. **Window Check:** If current time is within the 5ms sliding window, drop packet

5. **Window Advance:** If packet is allowed, advance window by `tx_time`

### Example Calculation:

Assume:

- MBR = 100,000 kbps (100 Mbps)
- Packet size = 1500 bytes
- Window size = 5,000,000 ns (5 ms)

Step 1: Calculate transmission time at 100 Mbps

```
tx_time = (1500 bytes × 8 bits/byte) × (1,000,000,000 ns/sec) /
100,000,000 bps
= 12,000,000,000 / 100,000,000
= 120 ns
```

Step 2: Check if packet fits in window

```
current_time = 1000000000 ns
window_start = 999990000 ns
if (window_start + tx_time > current_time):
 DROP packet (would exceed rate limit)
```

Step 3: If allowed, advance window

```
window_start = window_start + 120 ns
PASS packet
```

## Sliding Window Behavior

### 5ms Window Size:

- The algorithm uses a 5 millisecond sliding window
- Window automatically resets if idle for more than 5ms
- Prevents burst starvation while enforcing average rate

## Burst Handling:

- Small bursts are allowed within the 5ms window
- Sustained traffic above MBR is rate-limited
- More accurate than simple token bucket algorithms

## Per-Direction Rate Limiting:

- Uplink MBR uses `qer->ul_start` timestamp
- Downlink MBR uses `qer->dl_start` timestamp
- Each direction is rate-limited independently

## Rate Limit Enforcement Points

### Uplink (N3 → N6):

1. Packet arrives on N3 interface (from gNB)
2. PDR lookup by TEID
3. QER lookup by QER ID
4. Check `ul_gate_status` → drop if closed
5. Apply `limit_rate_sliding_window()` with `ul_maximum_bitrate`
6. If passed, forward to N6 and update URR counters

### Downlink (N6 → N3):

1. Packet arrives on N6 interface (from Data Network)
2. PDR lookup by UE IP address
3. QER lookup by QER ID
4. Check `dl_gate_status` → drop if closed
5. Apply `limit_rate_sliding_window()` with `dl_maximum_bitrate`
6. If passed, add GTP-U header and forward to N3

### N9 Loopback (SGWU ↔ PGWU):

- Both uplink and downlink QERs may apply in N9 loopback scenarios
- Each QER is checked independently at SGWU and PGWU boundaries

## MBR vs. Observed Throughput

## Why observed throughput may differ from MBR:

- **Protocol Overhead:** GTP-U, UDP, IP headers add ~50-60 bytes per packet
- **Packet Size Variance:** Smaller packets = more overhead, lower efficiency
- **Rate Limit Precision:** Enforcement happens per-packet, not per-byte
- **Window Reset Behavior:** 5ms idle periods allow brief bursts above MBR

## Example:

```
Configured MBR: 100 Mbps
Observed Throughput: ~95-98 Mbps (due to GTP-U/UDP/IP overhead)
```

## How to Verify Rate Limiting:

1. Check URR volume counters over time: `upf_urr*_volume_bytes`
2. Calculate throughput:  $(\text{volume\_delta\_bytes} \times 8) / \text{time\_delta\_seconds} / 1000 = \text{kbps}$
3. Compare against configured MBR in QER

## GBR (Guaranteed Bit Rate)

**Important:** OmniUPF does **not** currently enforce GBR minimums. GBR is stored in the QER but not used for traffic prioritization or admission control.

## GBR Behavior:

- GBR values are accepted from SMF via PFCP
- GBR is stored in QER map and visible via API
- **No bandwidth reservation** or traffic prioritization based on GBR
- GBR serves as metadata for tracking flow type (best-effort vs. guaranteed)

## Future Enhancement:

- GBR enforcement requires traffic scheduling or weighted queuing
- May be implemented using eBPF QoS capabilities in future releases

# Usage Reporting Rules (URR)

## Purpose

URRs track data volumes for charging, analytics, and policy enforcement. They maintain packet and byte counters that are reported to the SMF for charging records.

## URR Structure

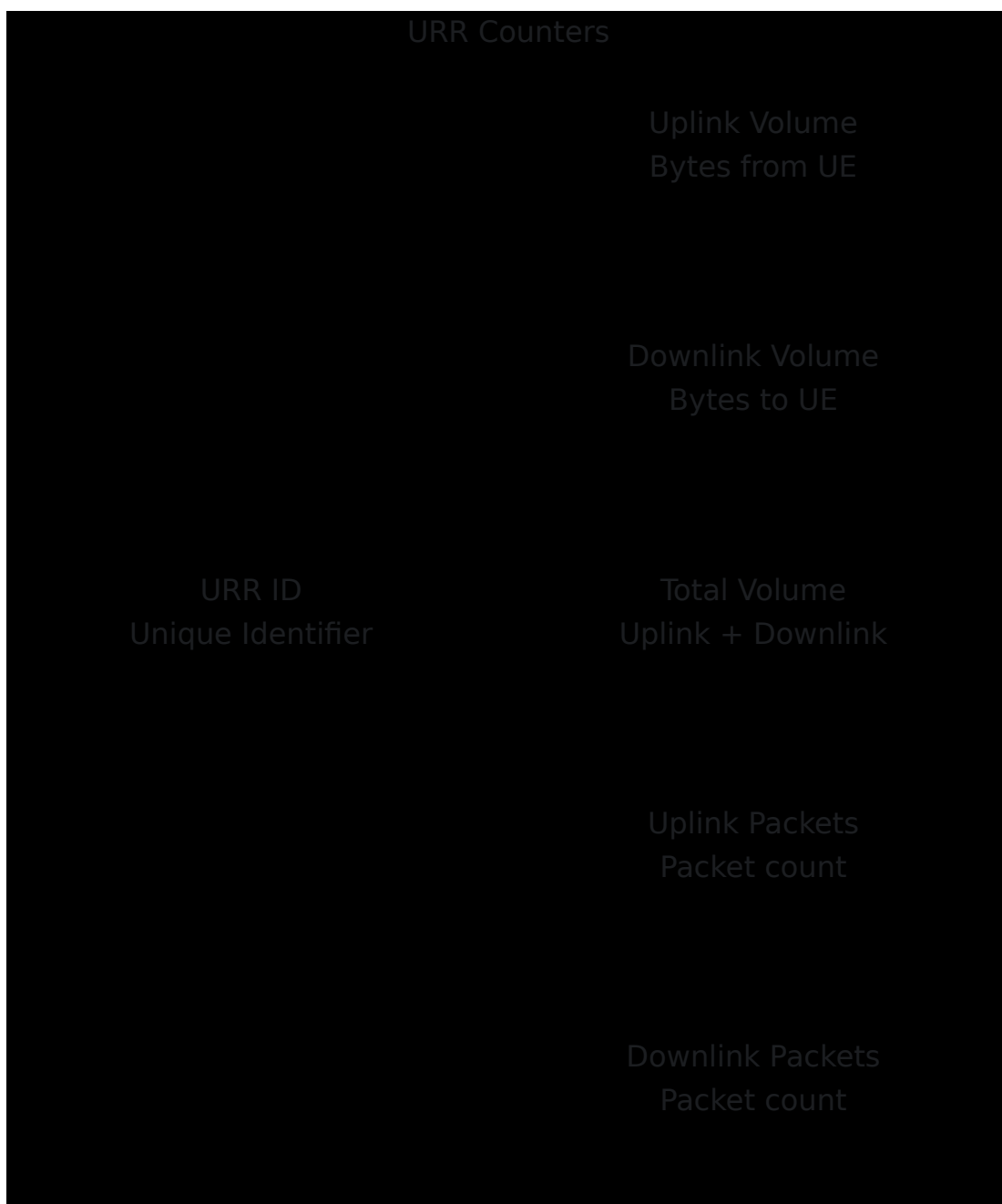

# Volume Tracking

## Uplink Volume:

- Bytes transmitted from UE to Data Network
- Measured after GTP-U decapsulation
- Includes IP header and payload

## Downlink Volume:

- Bytes transmitted from Data Network to UE
- Measured before GTP-U encapsulation
- Includes IP header and payload

## Total Volume:

- Sum of uplink and downlink volumes
- Used for total usage reporting

# Usage Reporting Triggers

URRs can trigger reports based on:

## Volume Threshold:

- Report when volume exceeds configured limit
- Example: Report every 1 GB of usage

## Time Threshold:

- Report at periodic intervals
- Example: Report every 5 minutes

## Event-Based:

- Report on session termination
- Report on QoS change
- Report on handover

# Volume Display Formatting

The Web UI automatically formats volume in human-readable units:

Bytes	Display
0 - 1023	B (Bytes)
1024 - 1048575	KB (Kilobytes)
1048576 - 1073741823	MB (Megabytes)
1073741824 - 1099511627775	GB (Gigabytes)
1099511627776+	TB (Terabytes)

## Example:

```
URR ID: 0
Uplink Volume: 12.3 KB
Downlink Volume: 9.0 KB
Total Volume: 21.3 KB
```



# URR Reporting Flow

## QER Parameters

OmniCharge

OmniRAN

Downloads

English

OmniTouch We

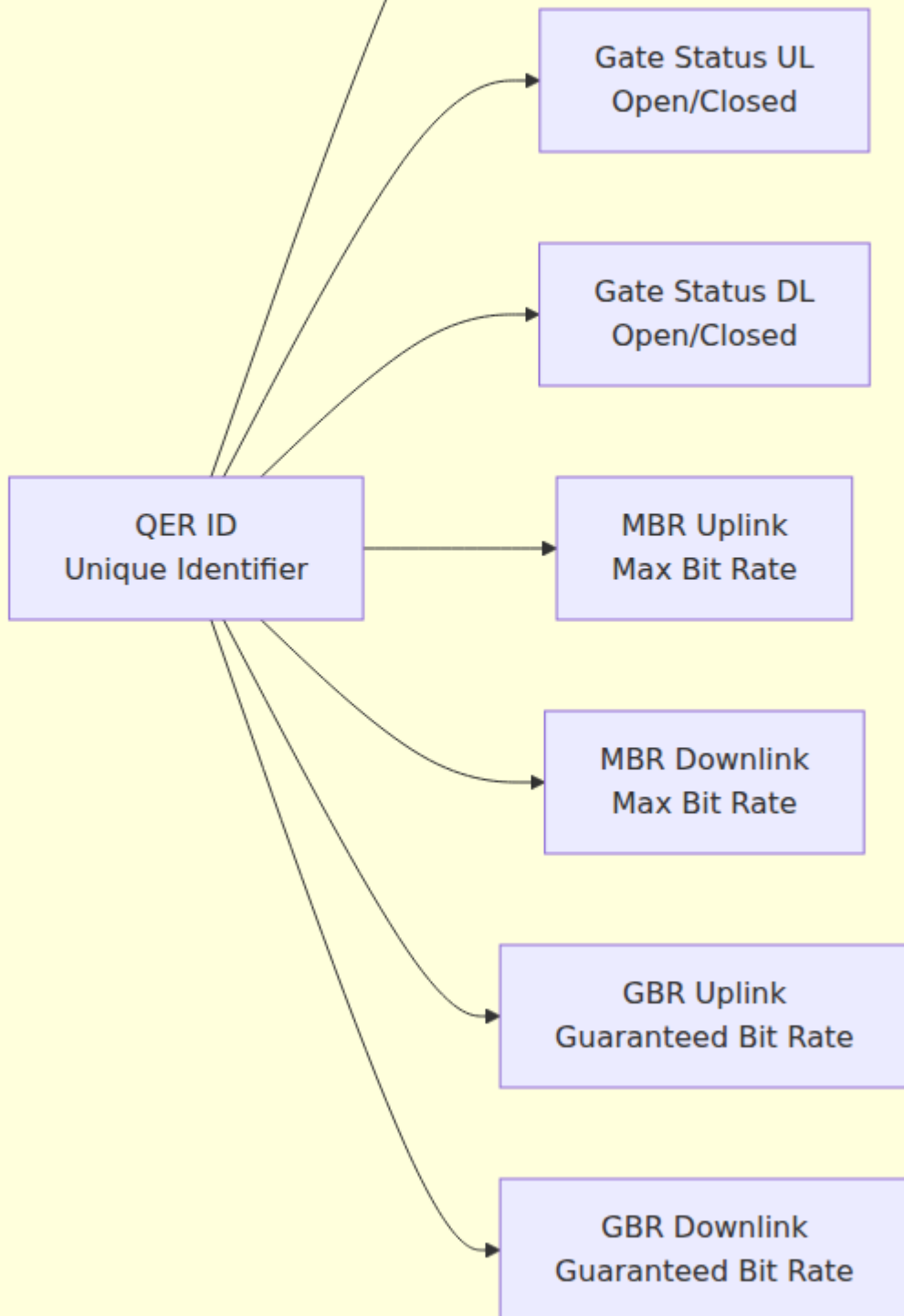

# Rule Relationships

## PDR → FAR → QER → URR Chain

Each PDR references a FAR, which may reference a QER and one or more URRs.

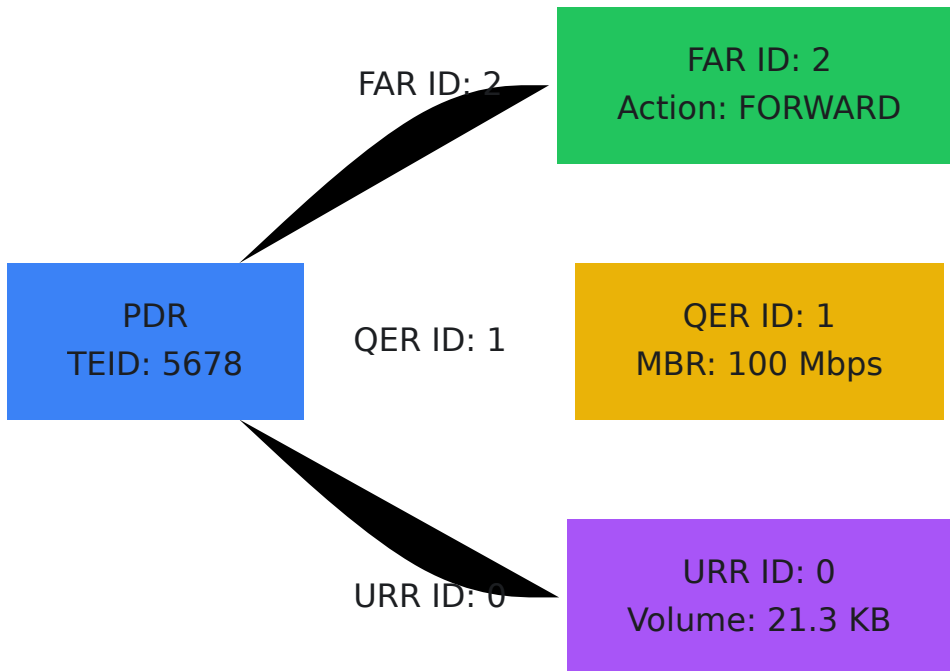

## Example Session Configuration

### Uplink PDR:

```
TEID: 5678
FAR ID: 2
QER ID: 1
URR IDs: [0]
Outer Header Removal: False
```

### Downlink PDR:

UE IP: 10.45.0.1  
FAR ID: 1  
QER ID: 1  
URR IDs: [0]  
SDF Mode: No SDF

#### **FAR ID 1 (Downlink):**

Action: 2 (FORWARD)  
Outer Header Creation: True  
Remote IP: 200.198.5.10  
TEID: 5678

#### **FAR ID 2 (Uplink):**

Action: 2 (FORWARD)  
Outer Header Creation: False

#### **QER ID 1:**

QFI: 9  
MBR Uplink: 100000 kbps  
MBR Downlink: 100000 kbps  
GBR Uplink: 0 kbps  
GBR Downlink: 0 kbps

#### **URR ID 0:**

Uplink Volume: 12.3 KB  
Downlink Volume: 9.0 KB  
Total Volume: 21.3 KB

# Common Operations

## View Rules for a Session

### Via Sessions Page:

1. Navigate to Sessions
2. Find UE by IP or TEID
3. Click "Expand" to view all rules (PDR, FAR, QER, URR)

### Via Rules Page:

1. Navigate to Rules
2. Use lookup by TEID (uplink) or UE IP (downlink) in PDR tab
3. Note the FAR ID, QER ID, URR IDs
4. Switch to FAR/QER/URR tabs to view referenced rules

## Enable/Disable Buffering

**Scenario:** During handover, buffer packets to prevent loss

### Steps:

1. Navigate to Rules → FARs
2. Enter FAR ID in search field
3. Click "Lookup"
4. If buffering is OFF, click "Enable Buffering"
5. Verify FAR action bit 2 is set (Action value increases by 4)

### Alternative via Buffers Page:

1. Navigate to Buffers
2. View FARs with buffering enabled
3. Click "Disable Buffer" when handover completes

# Monitor QoS Compliance

## Check if traffic is being rate-limited:

1. Navigate to Rules → QERs
2. Find QER ID associated with UE session
3. Note MBR Uplink and MBR Downlink values
4. Compare with URR volume growth rate

## Calculate Average Throughput:

Throughput (kbps) = (Volume Delta in bytes × 8) / (Time Delta in seconds × 1000)

If throughput approaches MBR, traffic is being rate-limited.

# Track Data Usage

## Monitor URR volumes:

1. Navigate to Rules → URRs
2. View uplink, downlink, and total volumes
3. Sort by Total Volume to find highest users
4. Refresh periodically to observe volume growth

## Use Cases:

- Verify charging integration
- Detect abnormal data usage
- Plan capacity based on traffic patterns

# Troubleshooting

## No Traffic Flowing

### Check PDR:

1. Verify PDR exists for TEID (uplink) or UE IP (downlink)
2. Confirm FAR ID is valid
3. Check SDF filters aren't blocking traffic

#### **Check FAR:**

1. Verify FAR action is FORWARD (not DROP or BUFFER only)
2. Confirm outer header creation matches direction
3. Verify Remote IP and TEID are correct for downlink

#### **Check QER:**

1. Verify Gate Status is Open (0)
2. Check MBR is not too restrictive

## **Packets Being Dropped**

#### **Check QER Rate Limiting:**

1. Navigate to Rules → QERs
2. Verify MBR is adequate for traffic load
3. Check URR volume growth matches expected throughput

#### **Check FAR Action:**

1. Navigate to Rules → FARs
2. Verify action is FORWARD, not DROP
3. Check buffering isn't stuck in BUFFER-only mode

## **Buffering Issues**

#### **Packets stuck in buffer:**

1. Navigate to Buffers page
2. Check oldest packet timestamp
3. If > 30 seconds, handover may have failed
4. Manually flush or clear buffer

5. Disable buffering on FAR

### **Buffer overflow:**

1. Check total packets vs. Max Total (default 100,000)
2. Check per-FAR packets vs. Max Per FAR (default 10,000)
3. Clear buffers if full
4. Investigate why buffering wasn't disabled

## **URR Not Tracking**

### **Volume counters at zero:**

1. Verify PDR references URR ID
2. Check that packets are matching PDR
3. Verify FAR is forwarding (not dropping) packets
4. Confirm URR ID exists in URR map

### **Volume not reporting to SMF:**

1. Check PFCP Session Report configuration
2. Verify URR reporting triggers (volume/time thresholds)
3. Review logs for PFCP Session Report messages

## **Related Documentation**

- **UPF Operations Guide** - Overview of OmniUPF architecture and components
- **Web UI Operations Guide** - Control panel usage for rule viewing
- **Monitoring Guide** - Statistics and capacity monitoring
- **Troubleshooting Guide** - Common issues and diagnostics

# OmniUPF

# Troubleshooting Guide

## Table of Contents

1. [Overview](#)
  2. [Diagnostic Tools](#)
  3. [Installation Issues](#)
  4. [Configuration Problems](#)
  5. [PFCP Association Issues](#)
  6. [Packet Processing Problems](#)
  7. [XDP and eBPF Issues](#)
  8. [Performance Issues](#)
  9. [Hypervisor-Specific Issues](#)
  10. [NIC and Driver Issues](#)
  11. [Session Establishment Failures](#)
  12. [Buffering Issues](#)
- 

## Overview

This guide provides systematic troubleshooting procedures for common OmniUPF issues. Each section includes symptoms, diagnosis steps, root causes, and resolution procedures.

## Quick Diagnostic Checklist

Before deep troubleshooting, verify:

```
1. Check OmniUPF is running
systemctl status omniupf

2. Check PFCP association
curl http://localhost:8080/api/v1/upf_pipeline

3. Check eBPF maps are loaded
ls /sys/fs/bpf/

4. Check XDP program is attached
ip link show | grep -i xdp

5. Check kernel logs for errors
dmesg | tail -50
journalctl -u omniupf -n 50
```

---

# Diagnostic Tools

## OmniUPF REST API

### Check UPF status:

```
curl http://localhost:8080/api/v1/upf_status
```

### Check PFCP associations:

```
curl http://localhost:8080/api/v1/upf_pipeline
```

### Check session count:

```
curl http://localhost:8080/api/v1/sessions | jq 'length'
```

### Check eBPF map capacity:

```
curl http://localhost:8080/api/v1/map_info
```

### **Check packet statistics:**

```
curl http://localhost:8080/api/v1/packet_stats
```

### **Check XDP statistics:**

```
curl http://localhost:8080/api/v1/xdp_stats
```

---

## **eBPF Map Inspection**

### **List all eBPF maps:**

```
ls -lh /sys/fs/bpf/
bpftool map list
```

### **Show map details:**

```
bpftool map show
bpftool map dump name pdr_map_downlin
```

### **Count entries in map:**

```
bpftool map dump name far_map | grep -c "key:"
```

---

## **XDP Program Inspection**

### **Check if XDP program is attached:**

```
ip link show eth0 | grep xdp
```

### List all XDP programs:

```
bpftool net list
```

### Show XDP program details:

```
bpftool prog show
```

### Dump XDP statistics:

```
bpftool prog dump xlated name xdp_upf_func
```

---

## Network Debugging

### Capture PFCP traffic on N4 (control plane):

```
PFCP is not processed by XDP, tcpdump works normally
tcpdump -i eth0 -n udp port 8805 -w /tmp/pfcp_traffic.pcap
```

### Capture GTP-U traffic on N3 (requires out-of-band capture):

```
WARNING: Standard tcpdump on UPF host CANNOT capture XDP-processed packets!
XDP processes GTP-U before the kernel network stack sees packets.

Use out-of-band capture instead:
1. Network TAP between gNB and UPF
2. Switch port mirroring/SPAN to copy N3 traffic
3. Virtual switch port mirroring to analyzer VM

On analyzer/monitoring host (NOT on UPF):
tcpdump -i <mirror_interface> -n udp port 2152 -w /tmp/n3_capture.pcap

Or use statistics API for packet counts:
curl http://localhost:8080/api/v1/packet_stats
curl http://localhost:8080/api/v1/n3n6_stats
```

### **Monitor packet counters:**

```
watch -n 1 'ip -s link show eth0'
```

### **Check routing table:**

```
ip route show
ip route get 10.45.0.100 # Check route for UE IP
```

### **Check ARP table:**

```
ip neigh show
```

---

# Installation Issues

## Issue: "eBPF filesystem not mounted"

### Symptoms:

```
ERR0[0000] failed to load eBPF objects: mount bpf filesystem at /sys/fs/bpf
```

**Cause:** eBPF filesystem not mounted

### Resolution:

```
Mount eBPF filesystem
sudo mount bpffs /sys/fs/bpf -t bpf

Make persistent (add to /etc/fstab)
echo "bpffs /sys/fs/bpf bpf defaults 0 0" | sudo tee -a /etc/fstab

Verify mount
mount | grep bpf
```

---

## Issue: Kernel version too old

### Symptoms:

```
ERR0[0000] kernel version 5.4.0 is too old, minimum required is 5.15.0
```

**Cause:** Linux kernel version below minimum requirement

### Resolution:

```
Check kernel version
uname -r

Upgrade kernel (Ubuntu/Debian)
sudo apt update
sudo apt install linux-generic-hwe-22.04
sudo reboot

Verify new kernel
uname -r # Should be >= 5.15.0
```

---

## Issue: Missing libbpf dependency

### Symptoms:

```
error while loading shared libraries: libbpf.so.0: cannot open
shared object file
```

**Cause:** libbpf library not installed

### Resolution:

```
Install libbpf (Ubuntu/Debian)
sudo apt update
sudo apt install libbpf-dev

Verify installation
ldconfig -p | grep libbpf
```

---

## Configuration Problems

### Issue: Invalid configuration file

#### Symptoms:

```
ERR0[0000] unable to read config file: unmarshal errors
```

**Cause:** YAML syntax error in config file

**Resolution:**

```
Validate YAML syntax
cat config.yml | python3 -c "import yaml, sys;
yaml.safe_load(sys.stdin)"

Common issues:
- Incorrect indentation (use spaces, not tabs)
- Missing colons after keys
- Unquoted strings with special characters
- List items without hyphens

Example of correct YAML:
cat > config.yml <<EOF
interface_name: [eth0]
xdp_attach_mode: generic
api_address: :8080
pfc_p_address: :8805
EOF
```

---

## Issue: Interface name not found

**Symptoms:**

```
ERR0[0000] interface eth0 not found
```

**Cause:** Configured interface does not exist

**Resolution:**

```
List all network interfaces
ip link show

Check interface status
ip addr show eth0

If interface has different name, update config.yml:
interface_name: [ens1f0] # Use actual interface name

For VMs, check interface naming scheme
ls /sys/class/net/
```

---

## Issue: Port already in use

### Symptoms:

```
ERR0[0000] failed to start API server: address already in use
```

**Cause:** Port 8080, 8805, or 9090 already bound by another process

### Resolution:

```
Find process using port
sudo lsof -i :8080
sudo netstat -tulpn | grep :8080

Kill conflicting process
sudo kill <PID>

Or change OmniUPF port in config
api_address: :8081
pfcg_address: :8806
metrics_address: :9091
```

---

## Issue: Invalid PFCP Node ID

### Symptoms:

```
ERR0[0000] invalid pfcpc_node_id: must be valid IPv4 address
```

**Cause:** PFCP Node ID is not a valid IPv4 address

### Resolution:

```
Correct: Use IP address (not hostname)
pfcpc_node_id: 10.100.50.241

Incorrect:
pfcpc_node_id: localhost
pfcpc_node_id: upf.example.com
```

---

## PFCP Association Issues

### Issue: No PFCP associations established

#### Symptoms:

- Web UI shows "No associations"
- SMF logs show "PFCP Association Setup failure"

#### Diagnosis:

```
1. Check if PFCP server is listening
sudo netstat -ulpn | grep 8805

2. Check firewall rules
sudo iptables -L -n | grep 8805
sudo ufw status

3. Capture PFCP traffic
tcpdump -i any -n udp port 8805 -vv

4. Check PFCP associations via API
curl http://localhost:8080/api/v1/upf_pipeline
```

## Common Causes & Resolutions:

### Firewall blocking PFCP

#### Resolution:

```
Allow PFCP traffic (UDP 8805)
sudo ufw allow 8805/udp
sudo iptables -A INPUT -p udp --dport 8805 -j ACCEPT
```

### Wrong PFCP Node ID

#### Resolution:

```
Set PFCP Node ID to correct N4 interface IP
pfcpc_node_id: 10.100.50.241 # Must match IP on N4 network
```

### Network unreachable to SMF

#### Resolution:

```
Test connectivity to SMF
ping <SMF_IP>

Check routing to SMF
ip route get <SMF_IP>

Add route if missing
sudo ip route add <SMF_NETWORK>/24 via <GATEWAY>
```

## SMF configured with wrong UPF IP

### Resolution:

- Check SMF configuration for UPF address
- Ensure SMF has UPF's `pfcp_node_id` IP configured
- Verify SMF can route to UPF's N4 network

---

## Issue: PFCP heartbeat failures

### Symptoms:

```
WARN[0030] PFCP heartbeat timeout for association 10.100.50.10
```

### Diagnosis:

```
Check PFCP statistics
curl http://localhost:8080/api/v1/upf_pipeline | jq
'.associations[] | {remote_id, uplink_teid_count}'

Monitor heartbeat logs
journalctl -u omniupf -f | grep heartbeat
```

### Causes & Resolutions:

#### Network packet loss

## Resolution:

```
Check packet loss to SMF
ping -c 100 <SMF_IP> | grep loss

If high loss, investigate network:
- Check link status
- Check switch/router health
- Check for congestion
```

## Heartbeat interval too aggressive

### Resolution:

```
Increase heartbeat interval
heartbeat_interval: 30 # Increase from 5 to 30 seconds
heartbeat_retries: 5 # Increase retries
heartbeat_timeout: 10 # Increase timeout
```

---

# Packet Processing Problems

## Issue: No packets flowing (RX/TX counters at 0)

### Symptoms:

- Statistics page shows 0 RX/TX packets
- UE cannot establish data session

### Diagnosis:

```
1. Check if XDP program is attached
ip link show eth0 | grep xdp

2. Check interface is UP
ip link show eth0

3. Check packet statistics (XDP-aware)
Note: tcpdump cannot see XDP-processed GTP-U packets
curl http://localhost:8080/api/v1/packet_stats
```

## **Resolutions:**

### **XDP program not attached**

#### **Resolution:**

```
Restart OmniUPF to re-attach XDP
sudo systemctl restart omniupf

Verify attachment
ip link show eth0 | grep xdp
bpftool net list
```

### **Interface down or no link**

#### **Resolution:**

```
Bring interface up
sudo ip link set eth0 up

Check link status
ethtool eth0 | grep "Link detected"

If link down, check physical connection or VM network config
```

### **Wrong interface configured**

#### **Resolution:**

```
Update config.yml with correct interface
interface_name: [ens1f0] # Use actual interface name from 'ip
link show'
```

---

## Issue: Packets received but not forwarded (high drop rate)

### Symptoms:

- RX counters increasing but TX counters not
- Drop rate > 1%

### Diagnosis:

```
Check drop statistics
curl http://localhost:8080/api/v1/xdp_stats | jq '.drop'

Check route statistics
curl http://localhost:8080/api/v1/packet_stats | jq '.route_stats'

Monitor packet drops
watch -n 1 'curl -s http://localhost:8080/api/v1/packet_stats | jq
".total_rx, .total_tx, .total_drop"'
```

### Common Causes:

#### No PDR match (unknown TEID or UE IP)

### Resolution:

```
Check if sessions exist
curl http://localhost:8080/api/v1/sessions

If no sessions, verify:
- PFCP association is established
- SMF has created sessions
- Session establishment was successful

Check PDR map entries
bpftool map dump name pdr_map_teid_ip | grep -c key
bpftool map dump name pdr_map_downlin | grep -c key
```

## Routing failures

### Resolution:

```
Check FIB lookup failures
curl http://localhost:8080/api/v1/packet_stats | jq '.route_stats'

Test routing for UE IP
ip route get 10.45.0.100

Add missing route
sudo ip route add 10.45.0.0/16 dev eth1 # Route UE pool to N6
```

## QER rate limiting

### Symptoms:

- Throughput lower than expected
- Traffic capped at a specific rate
- URR volume counters show plateau behavior
- XDP drop counters increasing during traffic bursts

### Diagnosis:

1. **Check configured MBR for the session:**

```
Find the session's QER ID
curl http://localhost:8080/api/v1/pfcp_sessions | jq '.data[] |
select(.ue_ip == "10.45.0.1")'

Look up the QER configuration
curl http://localhost:8080/api/v1/qer_map | jq '.data[] |
select(.qer_id == 1)'
```

## 2. Verify gate status:

```
Gate status should be 0 (OPEN) for both uplink and downlink
curl http://localhost:8080/api/v1/qer_map | jq '.data[] |
{qer_id, ul_gate: .ul_gate_status, dl_gate: .dl_gate_status}'
```

## 3. Calculate actual throughput from URR:

```
Query URR volume counters at two points in time
curl http://localhost:8080/api/v1/urr_map | jq '.data[] |
select(.urr_id == 0)'
```

# Calculate throughput (manual):  
# throughput\_kbps = (volume\_delta\_bytes × 8) /  
time\_delta\_seconds / 1000

## 4. Compare MBR vs. actual throughput:

- Expected throughput ≈ 95-98% of MBR (due to protocol overhead)
- If throughput is significantly below MBR, check for other bottlenecks
- If throughput matches MBR exactly, rate limiting is working as expected

## Resolution:

- **If MBR is too low:** Request SMF to update QER with higher MBR via PFCP Session Modification
- **If gate is closed:** Investigate why SMF closed the gate (policy, quota, or error)

- **If rate limiting is unexpected:** Verify SMF policy configuration and QoS profile

### **Understanding MBR Enforcement:**

OmniUPF uses a sliding window algorithm to enforce MBR limits at nanosecond precision in the eBPF datapath. See [Rules Management Guide - MBR Enforcement Mechanism](#) for detailed explanation of:

- How packet size and rate determine drop decisions
- Why observed throughput differs from configured MBR
- Per-direction (uplink/downlink) rate limiting
- 5ms sliding window behavior

### **Common Scenarios:**

- **VoIP calls dropping:** Check if MBR is sufficient for codec bitrate (G.711 = ~80 kbps)
  - **Video streaming buffering:** Ensure MBR > video bitrate + overhead (1080p = ~5-10 Mbps)
  - **Burst traffic:** Small bursts allowed within 5ms window, sustained traffic rate-limited
- 

## **Issue: One-way traffic (uplink works, downlink doesn't)**

### **Symptoms:**

- RX N3 packets but no TX N3 packets (downlink problem)
- RX N6 packets but no TX N6 packets (uplink problem)

### **Diagnosis:**

```
Check N3/N6 interface statistics (XDP-aware method)
curl http://localhost:8080/api/v1/n3n6_stats
curl http://localhost:8080/api/v1/packet_stats

Note: Standard tcpdump cannot capture XDP-processed GTP-U
traffic
Use statistics API or xdpdump for traffic analysis
See "Packet Capture with XDP" section for details
```

### **Uplink Failure (RX N3, no TX N6):**

**Cause:** No FAR action or routing issue to N6

### **Resolution:**

```
Check FAR has FORWARD action
curl http://localhost:8080/api/v1/sessions | jq '.[].fars[] |
select(.applied_action == 2)'
```

```
Check N6 route exists
ip route get 8.8.8.8 # Test route to internet

Add default route if missing
sudo ip route add default via <N6_GATEWAY> dev eth1
```

### **Downlink Failure (RX N6, no TX N3):**

**Cause:** No downlink PDR or missing GTP encapsulation

### **Resolution:**

```
Check downlink PDR exists for UE IP
curl http://localhost:8080/api/v1/sessions | jq '[][].pdrs[] |
select(.pdi.ue_ip_address)'

Verify FAR has OUTER_HEADER_CREATION
curl http://localhost:8080/api/v1/sessions | jq '[][].fars[] |
.outer_header_creation'

Check gNB reachability
ping <GNB_N3_IP>
```

---

## XDP and eBPF Issues

For detailed XDP configuration, mode selection, and troubleshooting, see the [XDP Modes Guide](#).

### Issue: XDP program failed to load

#### Symptoms:

```
ERR0[0000] failed to load XDP program: invalid argument
```

#### Diagnosis:

```
Check kernel XDP support
grep XDP /boot/config-$(uname -r)

Should show:
CONFIG_XDP_SOCKETS=y
CONFIG_BPF=y
CONFIG_BPF_SYSCALL=y

Check dmesg for detailed error
dmesg | grep -i bpf
```

#### Causes & Resolutions:

## Kernel lacks XDP support

### Resolution:

```
Rebuild kernel with XDP support or upgrade to newer kernel
Ubuntu 22.04+ has XDP enabled by default
sudo apt install linux-generic-hwe-22.04
sudo reboot
```

## XDP program verification failure

### Resolution:

```
Check OmniUPF logs for verifier errors
journalctl -u omniupf | grep verifier

Common issues:
- eBPF complexity exceeds limits (increase kernel limits)
- Invalid memory access (bug in eBPF code)

Increase eBPF verifier log level for debugging
sudo sysctl kernel.bpf_stats_enabled=1
```

---

## Issue: XDP aborted count increasing

### Symptoms:

- XDP stats show aborted > 0
- Packet drops increasing

### Diagnosis:

```
Check XDP aborted count
curl http://localhost:8080/api/v1/xdp_stats | jq '.aborted'

Monitor XDP stats
watch -n 1 'curl -s http://localhost:8080/api/v1/xdp_stats'
```

**Cause:** eBPF program encountered runtime error

**Resolution:**

```
Check kernel logs for eBPF errors
dmesg | grep -i bpf

Restart OmniUPF to reload eBPF program
sudo systemctl restart omniupf

If issue persists, enable eBPF logging (requires rebuild):
Build OmniUPF with BPF_ENABLE_LOG=1
```

---

## Issue: eBPF map full (capacity exhausted)

**Symptoms:**

- Session establishment fails
- Map capacity at 100%

**Diagnosis:**

```
Check map capacity
curl http://localhost:8080/api/v1/map_info | jq '.[[] | {map_name,
capacity, used, usage_percent}''

Identify full maps
curl http://localhost:8080/api/v1/map_info | jq '.[[] |
select(.usage_percent > 90)'
```

**Immediate Mitigation:**

```
1. Identify stale sessions
curl http://localhost:8080/api/v1/sessions | jq '.[[] | {seid,
uplink_teid, created_at}'

2. Request SMF to delete old sessions
(via SMF admin interface or API)

3. Monitor map usage decrease
watch -n 5 'curl -s http://localhost:8080/api/v1/map_info | jq ".
[] | select(.map_name=="pdr_map_downlin") | .usage_percent"'
```

### Long-term Resolution:

```
Increase map capacity in config.yml
max_sessions: 200000 # Increase from 100000

Or set individual map sizes
pdr_map_size: 400000
far_map_size: 400000
qer_map_size: 200000
```

**Important:** Changing map sizes requires OmniUPF restart and **clears all existing sessions.**

---

## Performance Issues

### Issue: Low throughput (below expected)

#### Symptoms:

- Throughput < 1 Gbps despite capable NIC
- High CPU utilization

#### Diagnosis:

```
Check packet rate
curl http://localhost:8080/api/v1/packet_stats | jq '.total_rx,
.total_tx'

Check NIC statistics
ethtool -S eth0 | grep -i drop

Check XDP mode
ip link show eth0 | grep xdp
```

## Resolutions:

### Using generic XDP mode

#### Resolution:

```
Switch to native mode for better performance
xdp_attach_mode: native # Requires XDP-capable NIC/driver
```

### Single-core bottleneck

#### Resolution:

```
Enable RSS (Receive Side Scaling) on NIC
ethtool -L eth0 combined 4 # Use 4 RX/TX queues

Verify RSS enabled
ethtool -l eth0

Pin interrupts to specific CPUs
See /proc/interrupts and use irqbalance or manual affinity
```

### Buffer bloat

#### Resolution:

```
Reduce buffer limits to decrease latency
buffer_max_packets: 5000
buffer_packet_ttl: 15
```

---

## Issue: High latency

### Symptoms:

- Ping latency > 50ms
- User experience degradation

### Diagnosis:

```
Test latency to UE
ping -c 100 <UE_IP> | grep avg

Check buffered packets
curl http://localhost:8080/api/v1/upf_buffer_info | jq
'.total_packets_buffered'

Check route cache performance
curl http://localhost:8080/api/v1/packet_stats | jq '.route_stats'
```

### Resolutions:

#### Packets being buffered excessively

#### Resolution:

```
Check why packets are buffered
curl http://localhost:8080/api/v1/upf_buffer_info | jq '.buffers[]
| {far_id, packet_count, direction}'

Clear buffers if stuck
(restart OmniUPF or trigger PFCP session modification to apply
FAR)
```

## FIB lookup latency

### Resolution:

```
Ensure route cache is enabled (build-time option)
Build with BPF_ENABLE_ROUTE_CACHE=1

Optimize routing table
Use fewer, more specific routes instead of many small routes
```

---

## Issue: Packet drops under load

### Symptoms:

- Drop rate increases with traffic
- RX errors on NIC

### Diagnosis:

```
Check NIC errors
ethtool -S eth0 | grep -E "drop|error|miss"

Check ring buffer size
ethtool -g eth0

Monitor drops in real-time
watch -n 1 'ethtool -S eth0 | grep -E "drop|miss"'
```

### Resolution:

```
Increase RX ring buffer size
ethtool -G eth0 rx 4096

Increase TX ring buffer size
ethtool -G eth0 tx 4096

Verify new settings
ethtool -g eth0
```

---

## Hypervisor-Specific Issues

For step-by-step hypervisor configuration instructions, see the [XDP Modes Guide](#).

### Proxmox: XDP not working in VM

#### Symptoms:

- Cannot attach XDP program in native mode
- Only generic mode works

**Cause:** VM using bridged networking without SR-IOV

#### Resolution:

##### Option 1: Use generic mode (simplest)

```
xdp_attach_mode: generic
```

##### Option 2: Configure SR-IOV passthrough

```
On Proxmox host:
1. Enable IOMMU
nano /etc/default/grub
Add: intel_iommu=on iommu=pt
update-grub
reboot

2. Create VFs
echo 4 > /sys/class/net/eth0/device/sriov_numvfs

3. Assign VF to VM in Proxmox UI
Hardware → Add → PCI Device → Select VF

In VM:
interface_name: [ens1f0] # SR-IOV VF
xdp_attach_mode: native
```

---

## VMware: Promiscuous mode required

### Symptoms:

- Packets not received by OmniUPF

**Cause:** vSwitch blocking non-matching MAC addresses

### Resolution:

```
Enable promiscuous mode on vSwitch (in vSphere Client):
1. Select vSwitch → Edit Settings
2. Security → Promiscuous Mode: Accept
3. Security → MAC Address Changes: Accept
4. Security → Forged Transmits: Accept
```

---

## VirtualBox: Performance very low

### Symptoms:

- Throughput < 100 Mbps

**Cause:** VirtualBox does not support SR-IOV or native XDP

**Resolution:**

```
Use generic mode (only option)
xdp_attach_mode: generic

Optimize VirtualBox settings:
- Use VirtIO-Net adapter (if available)
- Enable "Allow All" promiscuous mode
- Allocate more CPU cores to VM
- Use bridged networking instead of NAT

Consider migrating to KVM/Proxmox for better performance
```

---

## NIC and Driver Issues

### Issue: NIC driver does not support XDP

**Symptoms:**

```
ERR0[0000] failed to attach XDP program: operation not supported
```

**Diagnosis:**

```
Check NIC driver
ethtool -i eth0 | grep driver

Check if driver supports XDP
modinfo <driver_name> | grep -i xdp

List XDP-capable interfaces
ip link show | grep -B 1 "xdpgeneric\|xdpdrv\|xdpoffload"
```

## Resolution:

### Option 1: Use generic mode

```
xdp_attach_mode: generic
```

### Option 2: Update NIC driver

```
Check for driver updates (Ubuntu)
sudo apt update
sudo apt install linux-modules-extra-$(uname -r)

Or install vendor-specific driver
Example for Intel:
Download from https://downloadcenter.intel.com/
```

### Option 3: Replace NIC

```
Use XDP-capable NIC:
- Intel X710, E810
- Mellanox ConnectX-5, ConnectX-6
- Broadcom BCM57xxx (bnxt_en driver)
```

---

## Issue: Driver crashes or kernel panics

### Symptoms:

- Kernel panic after attaching XDP
- NIC stops responding

### Diagnosis:

```
Check kernel logs
dmesg | tail -100

Check for driver bugs
journalctl -k | grep -E "BUG:|panic:"
```

### **Resolution:**

```
1. Update kernel and drivers
sudo apt update
sudo apt upgrade
sudo reboot

2. Disable XDP offload (use native only)
xdp_attach_mode: native

3. Use generic mode as workaround
xdp_attach_mode: generic

4. Report bug to NIC vendor or Linux kernel team
```

---

# Session Establishment Failures

## Issue: Session establishment fails

### Symptoms:

- SMF reports session establishment failure
- UE cannot establish PDU session

See [PFCEP Cause Codes Reference](#) for common failure scenarios and resolutions.

### Diagnosis:

```
Check OmniUPF logs for session errors
journalctl -u omniupf | grep -i "session establishment"

Check PFCP session count
curl http://localhost:8080/api/v1/sessions | jq 'length'

Capture PFCP traffic during session establishment
tcpdump -i any -n udp port 8805 -w /tmp/pfcp_session.pcap
```

## **Common Causes:**

### **Map capacity full**

#### **Resolution:**

```
Check map usage
curl http://localhost:8080/api/v1/map_info | jq '.[0] |
select(.usage_percent > 90)'

Increase capacity (see eBPF map full section above)
```

### **Invalid PDR/FAR parameters**

#### **Resolution:**

```
Check OmniUPF logs for validation errors
journalctl -u omniupf | grep -E "invalid|error" | tail -20

Common issues:
- Invalid UE IP address (0.0.0.0 or duplicate)
- Invalid TEID (0 or duplicate)
- Missing FAR for PDR
- Invalid FAR action

Verify SMF configuration and session parameters
```

### **Feature not supported (UEIP/FTUP)**

#### **Resolution:**

```
Enable required features if needed
feature_ueip: true # UE IP allocation by UPF
ueip_pool: 10.60.0.0/16

feature_ftup: true # F-TEID allocation by UPF
teid_pool: 100000
```

---

# Buffering Issues

## Issue: Packets stuck in buffer

### Symptoms:

- Buffered packet count increasing
- Packets not delivered after handover

### Diagnosis:

```
Check buffer statistics
curl http://localhost:8080/api/v1/upf_buffer_info

Check individual FAR buffers
curl http://localhost:8080/api/v1/upf_buffer_info | jq '.buffers[]
| {far_id, packet_count, oldest_packet_ms}'

Monitor buffer size
watch -n 5 'curl -s http://localhost:8080/api/v1/upf_buffer_info |
jq ".total_packets_buffered"'
```

### Causes & Resolutions:

#### **FAR never updated to FORWARD**

**Cause:** SMF never sent PCFP Session Modification to apply FAR

#### **Resolution:**

```
Check FAR status
curl http://localhost:8080/api/v1/sessions | jq '[][.fars[] |
{far_id, applied_action}]'

Action BUFF = 1 (buffering)
Action FORW = 2 (forwarding)

If stuck in BUFF state, request SMF to:
- Send PFCP Session Modification Request
- Update FAR with FORW action
```

## Buffer TTL expired

**Cause:** Packets expired before FAR update

### Resolution:

```
Increase buffer TTL
buffer_packet_ttl: 60 # Increase from 30 to 60 seconds
```

## Buffer overflow

**Cause:** Too many packets buffered per FAR

### Resolution:

```
Increase buffer limits
buffer_max_packets: 20000 # Per FAR
buffer_max_total: 200000 # Global limit
```

---

# Advanced Debugging

## Enable Debug Logging

```
logging_level: debug # trace | debug | info | warn | error
```

```
Restart OmniUPF with debug logging
sudo systemctl restart omniupf

Monitor logs in real-time
journalctl -u omniupf -f --output cat
```

---

## eBPF Program Tracing

```
Trace eBPF program execution (requires bpftrace)
sudo bpftrace -e 'tracepoint:xdp:* { @[probe] = count(); }'

Trace map operations
sudo bpftrace -e 'tracepoint:bpf:bpf_map_lookup_elem {
printf("%s\n", str(args->map_name)); }'
```

---

## Packet Capture with XDP

### Understanding XDP Packet Capture Limitations:

XDP processes packets **before** the kernel network stack, so standard `tcpdump` **cannot see XDP-processed traffic**. GTP-U packets (UDP port 2152) on N3 are processed by XDP and will not appear in `tcpdump` on the UPF host.

### Recommended Methods for Traffic Analysis:

```
Method 1: Use statistics API for monitoring (RECOMMENDED)
curl http://localhost:8080/api/v1/xdp_stats
curl http://localhost:8080/api/v1/packet_stats | jq
curl http://localhost:8080/api/v1/n3n6_stats

Method 2: Capture PFCP traffic (not affected by XDP)
tcpdump -i any -n udp port 8805 -w /tmp/pfcp.pcap

Method 3: Out-of-band packet capture (RECOMMENDED for GTP-U)
Use network TAP or switch port mirroring to capture traffic
Examples:
- Physical TAP between gNB and UPF
- Switch SPAN/mirror port copying N3 traffic to analyzer
- Virtual switch port mirroring in hypervisor
#
On capture host (NOT the UPF):
tcpdump -i <mirror_interface> -n udp port 2152 -w
/tmp/n3_mirror.pcap
```

## **Out-of-Band Capture Setup Examples:**

### **Physical Network:**

```
Use a network TAP or configure switch port mirroring
Example: Cisco switch SPAN configuration
(config)# monitor session 1 source interface Gi1/0/1
(config)# monitor session 1 destination interface Gi1/0/24

On monitoring host connected to Gi1/0/24:
tcpdump -i eth0 -n udp port 2152 -w /tmp/n3_capture.pcap
```

### **Virtual Environment (VMware, KVM, etc.):**

```
Configure virtual switch port mirroring to send UPF traffic to analyzer VM
Example: Linux bridge with tcpdump on different VM
On hypervisor, mirror UPF's N3 interface to analyzer interface

On analyzer VM:
tcpdump -i eth1 -n udp port 2152 -w /tmp/n3_virtual.pcap
```

### **Why Out-of-Band is Required:**

- XDP bypasses the kernel network stack entirely
- Packets are processed in the NIC driver or hardware
- Host-based tcpdump sees packets AFTER XDP processing (too late)
- Out-of-band capture sees raw wire traffic before UPF processing

### **What You CAN Capture on UPF Host:**

- PFCP traffic (UDP 8805) - control plane, not processed by XDP
  - API responses and metrics
  - GTP-U traffic (UDP 2152) - dataplane, processed by XDP
- 

## **Getting Help**

If troubleshooting steps do not resolve your issue:

### **1. Collect diagnostic information:**

```
System info
uname -a
cat /etc/os-release

OmniUPF info
curl http://localhost:8080/api/v1/upf_status
curl http://localhost:8080/api/v1/map_info
curl http://localhost:8080/api/v1/packet_stats

Logs
journalctl -u omniupf --since "1 hour ago" > /tmp/omniupf.log
dmesg > /tmp/dmesg.log

Network info
ip addr > /tmp/network.txt
ip route >> /tmp/network.txt
ethtool eth0 >> /tmp/network.txt
```

## 2. Report issue with:

- OmniUPF version
- Linux kernel version
- Network topology diagram
- Configuration file (redact sensitive info)
- Relevant log excerpts
- Steps to reproduce

---

# Related Documentation

- **Configuration Guide** - Configuration parameters and examples
- **Architecture Guide** - eBPF/XDP internals and performance tuning
- **Monitoring Guide** - Statistics, capacity, and alerting
- **Metrics Reference** - Prometheus metrics for troubleshooting
- **PFCP Cause Codes** - PFCP error codes and troubleshooting
- **Rules Management Guide** - PDR, FAR, QER, URR concepts
- **Operations Guide** - UPF architecture and overview

# Web UI Operations Guide

## Table of Contents

1. [Overview](#)
2. [Accessing the Control Panel](#)
3. [Sessions View](#)
4. [Rules Management](#)
5. [Buffer Management](#)
6. [Statistics Dashboard](#)
7. [Capacity Monitoring](#)
8. [Configuration View](#)
9. [Routes View](#)
10. [XDP Capabilities View](#)
11. [Logs Viewer](#)

## Overview

The OmniUPF Web UI provides a comprehensive control panel for real-time monitoring and management of the User Plane Function. The interface is built on Phoenix LiveView and provides:

- **Real-time visibility** into PFCP sessions and active PDU connections
- **Rules inspection** for PDR, FAR, QER, and URR across all sessions
- **Buffer management** for packet buffering during mobility events
- **Statistics monitoring** for packet processing, routes, and interfaces
- **Capacity tracking** for eBPF map usage and limits
- **Live log viewing** for troubleshooting

# Architecture

The control panel communicates with multiple OmniUPF instances via their REST API to:

- Query PFCP sessions and associations
- Inspect packet detection and forwarding rules
- Monitor packet buffers and their status
- Access real-time statistics and performance metrics
- Track eBPF map capacity and utilization

## Accessing the Control Panel

### Default Access

The control panel is accessible via HTTPS on the OmniUPF management server:

```
https://<upf-server>:443/
```

**Default Port:** 443 (HTTPS with self-signed certificate)

### Configuration

The control panel requires OmniUPF host configuration in `config/config.exs`:

Multiple UPF instances can be configured for multi-instance deployments:

The `upf_hosts` configuration defines which OmniUPF instances are available in the host selector dropdown throughout the UI.

### Navigation

The control panel provides navigation tabs for each operational area:

- **Sessions** - `/sessions` - PFCP sessions and associations
- **Rules** - `/rules` - PDR, FAR, QER, URR rule inspection

- **Buffers** - `/buffers` - Packet buffer monitoring and control
- **Statistics** - `/statistics` - Packet, route, XDP, and interface statistics
- **Capacity** - `/capacity` - eBPF map usage and capacity monitoring
- **Config** - `/upf_config` - UPF configuration and dataplane addresses
- **Routes** - `/routes` - UE routes and routing protocol sessions (OSPF, BGP)
- **XDP Capabilities** - `/xdp_capabilities` - XDP mode support and performance capabilities
- **Logs** - `/logs` - Live log streaming

## Sessions View

**URL:** `/sessions`

### Features

The Sessions view displays all active PFCP sessions and associations from selected OmniUPF instances.

#### PFCP Associations Summary

Displays all active PFCP associations (control connections from SMF/PGW-C):

Column	Description
<b>Node ID</b>	SMF or PGW-C node identifier (FQDN or IP)
<b>Address</b>	SMF/PGW-C IP address for PFCP communication
<b>Next Session ID</b>	Next available PFCP session ID for this association

#### Purpose:

- Verify SMF connectivity to UPF
- Monitor number of control plane connections
- Track session ID allocation per association

## Active Sessions Table

Displays all PFCP sessions representing active UE PDU sessions:

Column	Description
<b>Local SEID</b>	UPF-assigned session endpoint identifier
<b>Remote SEID</b>	SMF-assigned session endpoint identifier
<b>UE IP</b>	User equipment IPv4 or IPv6 address
<b>TEID</b>	GTP-U Tunnel Endpoint Identifier for uplink traffic
<b>PDRs</b>	Number of packet detection rules in session
<b>FARs</b>	Number of forwarding action rules in session
<b>QERs</b>	Number of QoS enforcement rules in session
<b>URRs</b>	Number of usage reporting rules in session
<b>Actions</b>	Expand button to view detailed rule information

### Features:

- **Filter by IP:** Find sessions for specific UE IP address
- **Filter by TEID:** Find sessions by tunnel endpoint ID
- **Expand session:** View complete PDR/FAR/QER/URR JSON details
- **Auto-refresh:** Updates every 10 seconds

### Expanded Session View:

When you click "Expand" on a session, the view shows:

- **Packet Detection Rules (PDRs):** Complete JSON with TEID, UE IP, FAR ID, QER ID, SDF filters

- **PDR IDs are clickable** - Click to navigate to the Rules tab and view full PDR details
- Uplink PDRs (TEID ≠ 0) link to uplink PDR lookup
- Downlink PDRs (IPv4) link to downlink PDR lookup
- Downlink PDRs (IPv6) link to IPv6 downlink PDR lookup
- **Forwarding Action Rules (FARs)**: Action flags, outer header creation, destination endpoints
- **QoS Enforcement Rules (QERs)**: MBR, GBR, QFI, and other QoS parameters
- **Usage Reporting Rules (URRs)**: Volume counters (uplink, downlink, total bytes)

*Expanded session view showing detailed PDRs, FARs, and QERs for a specific session.*

## **Use Cases**

**Verify UE Connectivity:**

1. Navigate to Sessions view
2. Enter UE IP address in filter
3. Confirm session exists with correct TEID
4. Expand to verify PDR/FAR configuration

### **Monitor Session Count:**

- Check total session count in header
- Compare across multiple UPF instances
- Track session growth over time

### **Troubleshoot Session Issues:**

- Search for specific UE IP or TEID
- Expand session to inspect rule configuration
- Verify FAR forwarding parameters
- Check QER QoS settings

## **Real-time Updates**

The Sessions view automatically refreshes every 10 seconds. A health check indicator shows UPF connectivity status:

- **HEALTHY** (green): UPF is reachable and responding
- **UNHEALTHY** (red): UPF is not reachable or not responding
- **UNKNOWN** (gray): Health status not yet determined

## **Rules Management**

**URL:** `/rules`

The Rules view provides comprehensive inspection of all packet detection, forwarding, QoS, and usage reporting rules across all sessions.

# PDR Tab - Packet Detection Rules

View and inspect all PDRs in the UPF with **lookup forms** and **clickable navigation**:

## Uplink PDRs (N3 → N6):

- **Lookup Form:** Search by TEID to view specific uplink PDR details
- **TEID:** GTP-U tunnel endpoint ID from gNB (clickable - navigates to lookup)
- **FAR ID:** Associated forwarding action rule (clickable - navigates to FAR tab)
- **QER ID:** Associated QoS enforcement rule (clickable - navigates to QER tab)
- **URR IDs:** Associated usage reporting rules (clickable - navigates to URR tab)
- **Outer Header Removal:** GTP-U decapsulation flag
- **SDF Filters:** Service data flow classification rules

## Downlink PDRs (N6 → N3):

- **Lookup Form:** Search by UE IPv4 address to view specific downlink PDR details
- **UE IP:** IPv4 address of user equipment (displayed in lookup results)
- **FAR ID:** Associated forwarding action rule (clickable - navigates to FAR tab)
- **QER ID:** Associated QoS enforcement rule (clickable - navigates to QER tab)
- **URR IDs:** Associated usage reporting rules (clickable - navigates to URR tab)
- **SDF Mode:** Service data flow filter mode (none, sdf only, sdf + default)
- **Pagination:** Browse PDRs with page controls (default 100 per page, max 1000)

## IPv6 Downlink PDRs:

- API supports pagination for IPv6 downlink PDRs
- Same structure as IPv4 but keyed by IPv6 addresses
- Full UI tab can be added if needed

# FAR Tab - Forwarding Action Rules

View all FARs with their forwarding actions and parameters:

## Features:

- **Lookup Form:** Search by FAR ID to view specific FAR details
- **Auto-lookup:** Clicking FAR IDs from PDR details automatically populates lookup
- **Real-time Updates:** FAR status reflects current buffering state

Column	Description
<b>FAR ID</b>	Unique forwarding rule identifier
<b>Action</b>	Forwarding action flags (FORWARD, DROP, BUFFER, DUPLICATE, NOTIFY)
<b>Buffering</b>	Current buffering status (Enabled/Disabled)
<b>Destination</b>	Outer header creation parameters (TEID, IP address)

## FAR Action Flags:

- **FORWARD (1):** Forward packet to destination
- **DROP (2):** Discard packet
- **BUFFER (4):** Store packet in buffer
- **NOTIFY (8):** Send notification to control plane
- **DUPLICATE (16):** Duplicate packet to multiple destinations

## Buffering Toggle:

- Click "Enable Buffer" or "Disable Buffer" to toggle buffering flag
- Useful for troubleshooting handover scenarios
- Changes FAR action immediately in eBPF map

# QER Tab - QoS Enforcement Rules

View QoS rules applied to traffic flows:

## Features:

- **Clickable Navigation:** Click QER IDs from PDR details to navigate and highlight specific QER
- **Auto-highlight:** QER row is highlighted when navigated from PDR
- **Pagination:** Browse QERs with page controls (default 100 per page, max 1000)

Column	Description
<b>QER ID</b>	Unique QoS rule identifier (clickable when referenced from PDRs)
<b>MBR (Uplink)</b>	Maximum bit rate for uplink traffic (kbps)
<b>MBR (Downlink)</b>	Maximum bit rate for downlink traffic (kbps)
<b>GBR (Uplink)</b>	Guaranteed bit rate for uplink traffic (kbps)
<b>GBR (Downlink)</b>	Guaranteed bit rate for downlink traffic (kbps)
<b>QFI</b>	QoS Flow Identifier (5G marking)

## QoS Interpretation:

- **MBR = 0:** No rate limit
- **GBR = 0:** Best-effort (no guaranteed bandwidth)
- **GBR > 0:** Guaranteed bit rate flow (prioritized)

# URR Tab - Usage Reporting Rules

View usage tracking rules and volume counters:

## Features:

- **Lookup Form:** Search by URR ID to find and highlight specific URR
- **Clickable Navigation:** Click URR IDs from PDR details to navigate and highlight specific URR
- **Auto-highlight:** URR row is highlighted in blue when navigated from PDR or searched via lookup
- **Pagination:** Browse URRs with page controls (default 100 per page, max 1000)

Column	Description
<b>URR ID</b>	Unique usage reporting rule identifier (clickable when referenced from PDRs)
<b>Uplink Volume</b>	Bytes sent from UE to data network
<b>Downlink Volume</b>	Bytes sent from data network to UE
<b>Total Volume</b>	Total bytes in both directions
<b>Actions</b>	Delete button to reset counters for this URR

## Volume Display:

- Automatically formatted (B, KB, MB, GB, TB)
- Real-time counters updated every refresh
- Used for charging and analytics

## Filtering:

- Only shows URRs with non-zero volume

- Inactive URRs (all counters at 0) are filtered out for performance

## Use Cases

### Inspect Traffic Classification:

1. Navigate to Rules → PDR tab
2. Search for specific TEID or UE IP
3. Verify PDR associates with correct FAR and QER

### Troubleshoot Forwarding Issues:

1. Navigate to Rules → FAR tab
2. Locate FAR ID from session PDR
3. Verify action is FORWARD (not DROP or BUFFER)
4. Check outer header creation parameters

### Monitor QoS Enforcement:

1. Navigate to Rules → QER tab
2. Verify MBR and GBR values match policy
3. Check QFI marking for 5G flows

### Track Data Usage:

1. Navigate to Rules → URR tab
2. Sort by total volume to find highest users
3. Monitor volume growth over time
4. Verify charging integration

## Buffer Management

**URL:** `/buffers`

# Features

The Buffers view displays packet buffers maintained by the UPF during mobility events or path switches.

## Total Statistics

Dashboard displays aggregate buffer statistics:

- **Total Packets:** Number of buffered packets across all FARs
- **Total Bytes:** Total buffered data size
- **Total FARs:** Number of FARs with buffered packets
- **Max Per FAR:** Maximum packets allowed per FAR
- **Max Total:** Maximum total buffered packets
- **Packet TTL:** Time-to-live for buffered packets (seconds)

## Buffers by FAR

Table of all FARs with buffered packets:

Column	Description
<b>FAR ID</b>	Forwarding action rule identifier
<b>Packet Count</b>	Number of packets buffered for this FAR
<b>Byte Count</b>	Total bytes buffered for this FAR
<b>Oldest Packet</b>	Timestamp of oldest buffered packet
<b>Newest Packet</b>	Timestamp of newest buffered packet
<b>Actions</b>	Buffer control buttons (pill-style)

## Buffer Control Actions

For each FAR with buffered packets, the following pill-style buttons are available:

## **Buffering Control:**

- **Disable Buffer** (red): Turn off buffering for this FAR (updates FAR action flag)
- **Enable Buffer** (purple): Turn on buffering for this FAR

## **Buffer Operations:**

- **Flush** (blue): Replay all buffered packets using current FAR rules
- **Clear** (gray): Delete all buffered packets without forwarding

## **Clear All Buffers:**

- Red "Clear All" button in header
- Clears buffers for all FARs
- Requires confirmation

# **Use Cases**

## **Monitor Handover Buffering:**

1. During handover, verify packets are being buffered
2. Check FAR buffering status (should be enabled)
3. Monitor packet count and age

## **Complete Handover:**

1. After path switch, click "Flush" to replay buffered packets
2. Verify packets are forwarded to new path
3. Click "Disable Buffer" to stop buffering

## **Clear Stuck Buffers:**

1. Identify FARs with old buffered packets (check oldest timestamp)
2. Click "Clear" to discard stale packets
3. Or click "Disable Buffer" to prevent further buffering

## **Troubleshoot Buffer Overflow:**

1. Check total packet count vs. max total
2. Identify FARs with excessive buffering
3. Verify SMF has sent session modification to disable buffering
4. Manually disable buffering if SMF command missed

## Real-time Updates

The Buffers view automatically refreshes every 5 seconds to show current buffer status.

# Statistics Dashboard

**URL:** `/statistics`

## Features

The Statistics view provides real-time performance metrics from the OmniUPF datapath. For detailed information about Prometheus metrics, see the [Metrics Reference](#).

### Packet Statistics

Aggregate packet processing counters:

- **RX Packets:** Total packets received on all interfaces
- **TX Packets:** Total packets transmitted on all interfaces
- **Dropped Packets:** Packets discarded due to errors or policy
- **GTP-U Packets:** Packets processed with GTP-U encapsulation

**Use:** Monitor overall UPF traffic load and packet drop rate

### Route Statistics

Per-route forwarding metrics (if available):

- **Route hits:** Packets matched by each routing rule
- **Forwarding success:** Successfully forwarded packet count

- **Forwarding errors:** Failed forwarding attempts

**Use:** Identify busy routes and forwarding errors

## **XDP Statistics**

eXpress Data Path performance metrics:

- **XDP Processed:** Total packets processed at XDP layer
- **XDP Passed:** Packets sent to network stack
- **XDP Dropped:** Packets dropped at XDP layer
- **XDP Aborted:** Processing errors in XDP program

**Use:** Monitor XDP performance and detect processing errors

## **XDP Drop Causes:**

- Invalid packet format
- eBPF map lookup failure
- Policy-based drops
- Resource exhaustion

## **N3/N6 Interface Statistics**

Per-interface traffic counters:

### **N3 Interface** (RAN connectivity):

- **RX N3:** Packets received from gNB/eNodeB
- **TX N3:** Packets transmitted to gNB/eNodeB

### **N6 Interface** (Data Network connectivity):

- **RX N6:** Packets received from data network (Internet/IMS)
- **TX N6:** Packets transmitted to data network

**Total:** Aggregate packet count across interfaces

**Use:** Monitor traffic balance and interface-specific issues

# Use Cases

## Monitor Traffic Load:

1. Check packet RX/TX rates
2. Verify traffic is flowing in both directions
3. Compare N3 vs N6 traffic (should be roughly equal)

## Detect Packet Drops:

1. Check dropped packet counter
2. Review XDP dropped counter
3. Investigate cause in logs if drops are high

## Performance Analysis:

1. Monitor XDP processed vs. passed ratio
2. Check for XDP aborts (indicates errors)
3. Verify N3/N6 interface traffic distribution

## Capacity Planning:

1. Track packet rate over time
2. Compare to UPF capacity limits
3. Plan for scaling if approaching limits

# Real-time Updates

Statistics automatically refresh every 5 seconds.

# Capacity Monitoring

URL: `/capacity`

# Features

The Capacity view displays eBPF map usage and capacity limits for all maps in the UPF datapath.

## eBPF Map Usage Table

Table of all eBPF maps with usage information:

Column	Description
<b>Map Name</b>	eBPF map name (e.g., <code>uplink_pdr_map</code> , <code>far_map</code> )
<b>Used</b>	Number of entries currently in map
<b>Capacity</b>	Maximum entries allowed in map
<b>Usage</b>	Visual progress bar with percentage
<b>Key Size</b>	Size of map keys in bytes
<b>Value Size</b>	Size of map values in bytes

## Color-Coded Usage Indicators

The usage progress bar is color-coded based on utilization:

- **Green (<50%)**: Normal operation, ample capacity
- **Yellow (50-70%)**: Caution, monitor growth
- **Amber (70-90%)**: Warning, plan capacity increase
- **Red (>90%)**: Critical, immediate action required

## Critical Maps to Monitor

### `uplink_pdr_map`:

- Stores uplink PDRs keyed by TEID
- One entry per uplink traffic flow

- **Critical:** Exhaustion prevents new session establishment

#### **downlink\_pdr\_map / downlink\_pdr\_map\_ip6:**

- Stores downlink PDRs keyed by UE IP address
- One entry per UE IPv4/IPv6 address
- **Critical:** Exhaustion prevents new session establishment

#### **far\_map:**

- Stores forwarding action rules keyed by FAR ID
- Shared across multiple PDRs
- **High Priority:** Affects forwarding decisions

#### **qer\_map:**

- Stores QoS enforcement rules keyed by QER ID
- **Medium Priority:** Affects QoS but not basic connectivity

#### **urr\_map:**

- Stores usage reporting rules keyed by URR ID
- **Low Priority:** Affects charging but not connectivity

## **Use Cases**

### **Capacity Planning:**

1. Monitor map usage trends over time
2. Identify which maps are growing fastest
3. Plan capacity increases before reaching limits

### **Prevent Session Establishment Failures:**

1. Check PDR map usage before expected traffic surge
2. Increase map capacity if approaching limits
3. Monitor after capacity increase to verify

### **Troubleshoot Session Failures:**

1. When session establishment fails, check Capacity view
2. If PDR maps are red (>90%), capacity is exhausted
3. Increase map capacity or clear stale sessions

### **Optimize Map Configuration:**

1. Review key and value sizes
2. Calculate memory usage per map
3. Optimize map sizes based on actual usage patterns

## **Capacity Configuration**

eBPF map capacities are configured at UPF startup in the UPF configuration file.  
Typical values:

- Small deployment: 10,000 - 100,000 entries per map
- Medium deployment: 100,000 - 1,000,000 entries per map
- Large deployment: 1,000,000+ entries per map

### **Memory Calculation:**

```
Map Memory = (Key Size + Value Size) × Capacity
```

For example, a PDR map with 1 million entries and 64-byte values uses approximately 64 MB of kernel memory.

## **Real-time Updates**

Capacity view automatically refreshes every 10 seconds.

## **Configuration View**

**URL:** `/upf_config`

# Features

The Configuration view displays UPF operational parameters and dataplane configuration.

## UPF Configuration

Displays static UPF configuration:

- **PFCP Interface:** IP address and port for SMF/PGW-C connectivity
- **N3 Interface:** IP address for RAN (gNB/eNodeB) connectivity
- **N6 Interface:** IP address for data network connectivity
- **N9 Interface:** IP address for inter-UPF communication (optional)
- **API Port:** REST API listening port
- **Version:** OmniUPF software version

## Dataplane (eBPF) Configuration

Displays active runtime dataplane parameters:

- **Active N3 Address:** Runtime N3 interface binding
- **Active N9 Address:** Runtime N9 interface binding (if enabled)

These values reflect the actual eBPF datapath configuration and may differ from static configuration if interfaces have been changed.

# Use Cases

## Verify UPF Connectivity:

1. Check N3 interface IP matches gNB configuration
2. Verify N6 interface can route to data network
3. Confirm PFCP interface is reachable from SMF

## Troubleshoot Interface Issues:

1. Compare static config with dataplane active addresses
2. Verify interfaces are bound correctly

3. Check for interface configuration changes

### Documentation and Audit:

1. Record UPF configuration for documentation
2. Verify deployment matches design specifications
3. Audit interface assignments

## Routes View

URL: `/routes`

### Features

The Routes view provides comprehensive monitoring of User Equipment (UE) IP routes and routing protocol sessions (OSPF and BGP).

#### Route Status Overview

Dashboard displays aggregate route statistics:

- **Status:** Routing enabled or disabled
- **Total Routes:** Total number of UE IP routes
- **Synced:** Number of successfully synced routes
- **Failed:** Number of routes that failed to sync

#### Active UE IP Routes

Table displaying all active User Equipment IP routes:

Column	Description
Index	Route index number
UE IP Address	IPv4 or IPv6 address assigned to the UE

**Purpose:**

- View all UE IP addresses that have routes configured
- Verify route distribution to routing protocols
- Monitor route synchronization status

## OSPF Neighbors

Table of OSPF (Open Shortest Path First) protocol neighbors:

Column	Description
<b>Neighbor ID</b>	OSPF router identifier
<b>Address</b>	IP address of the OSPF neighbor
<b>Interface</b>	Interface used for OSPF adjacency
<b>State</b>	OSPF adjacency state (Full, Init, etc.)
<b>Priority</b>	OSPF priority value
<b>Up Time</b>	Duration the neighbor has been up
<b>Dead Time</b>	Time until neighbor is considered dead

## OSPF States:

- **Full** (green): Fully adjacent and exchanging routing information
- **Other states** (yellow): Adjacency forming or incomplete

## BGP Peers

Table of BGP (Border Gateway Protocol) peers:

Column	Description
<b>Neighbor IP</b>	IP address of the BGP peer
<b>ASN</b>	Autonomous System Number of the peer
<b>State</b>	BGP session state (Established, Idle, etc.)
<b>Up/Down</b>	Duration of current state
<b>Prefixes Received</b>	Number of route prefixes received from peer
<b>Msg Sent</b>	Total BGP messages sent to peer
<b>Msg Rcvd</b>	Total BGP messages received from peer

### **BGP States:**

- **Established** (green): Active BGP session, exchanging routes
- **Other states** (red): Session down or establishing

The header also displays the local BGP Router ID and ASN when BGP is configured.

### **OSPF Redistributed Routes**

Table showing OSPF External LSAs (Link State Advertisements) for redistributed UE routes:

<b>Column</b>	<b>Description</b>
<b>Link State ID</b>	LSA identifier (typically the network address)
<b>Mask</b>	Network mask for the route
<b>Advertising Router</b>	Router ID advertising this external route
<b>Metric Type</b>	OSPF external metric type (E1 or E2)
<b>Metric</b>	OSPF cost metric for the route
<b>Age</b>	Time since LSA was originated (seconds)
<b>Seq Number</b>	LSA sequence number for versioning

**Purpose:**

- Verify UE routes are being redistributed into OSPF
- Monitor which router is advertising external routes
- Track LSA aging and updates

## **Route Control Actions**

**Sync Routes Button:**

- Manually triggers route synchronization to FRR (Free Range Routing)
- Forces update of routing protocol with current UE routes
- Useful after configuration changes or to recover from sync failures

**Refresh Button:**

- Manually refresh all route information
- Updates OSPF neighbors, BGP peers, and route tables

# Use Cases

## **Monitor Routing Protocol Health:**

1. Navigate to Routes view
2. Check OSPF neighbor states (should be "Full")
3. Verify BGP peers are "Established"
4. Confirm expected number of neighbors/peers

## **Verify UE Route Distribution:**

1. Check Active UE IP Routes table for specific UE
2. Scroll to OSPF Redistributed Routes section
3. Verify UE route appears in external LSAs
4. Confirm advertising router matches expected UPF

## **Troubleshoot Route Sync Issues:**

1. Check Synced vs. Failed counters in status overview
2. If routes are failing, click "Sync Routes" button
3. Monitor error messages in red banner if sync fails
4. Check OSPF/BGP error messages in respective sections

## **Verify Multi-UPF Deployment:**

1. Select different UPF instances from dropdown
2. Compare route counts across instances
3. Verify OSPF neighbors see each other
4. Check BGP peering relationships

## **Monitor Route Scaling:**

1. Track total route count as UE sessions increase
2. Verify routes are distributed to routing protocols
3. Monitor OSPF LSA count growth
4. Check BGP prefix count received by peers

## Real-time Updates

The Routes view automatically refreshes every 10 seconds to show current routing protocol status and UE routes.

## Routing Integration

The Routes view integrates with FRR (Free Range Routing) running on the UPF:

- **OSPF:** Routes are redistributed as External Type-2 LSAs
- **BGP:** Routes are advertised to configured BGP peers
- **Sync mechanism:** REST API calls trigger vtysh commands to update FRR

## XDP Capabilities View

URL: `/xdp_capabilities`

### Features

The XDP Capabilities view displays eXpress Data Path (XDP) mode support, performance capabilities, and throughput calculations for the UPF dataplane.

### Interface Configuration

Displays network interface and driver information:

Field	Description
<b>Interface Name</b>	Network interface used for XDP (e.g., eth0, ens1f0)
<b>Driver</b>	Network driver name (e.g., i40e, ixgbe, virtio_net)
<b>Driver Version</b>	Driver version string
<b>Current Mode</b>	Active XDP mode (DRV, SKB, or NONE)
<b>Multi-Queue Count</b>	Number of NIC queue pairs for parallel processing

## XDP Modes

The view displays all XDP modes with their support status and performance characteristics:

### XDP\_DRV (Driver Mode):

- **Performance:** ~5-10 Mpps (millions of packets per second)
- **Description:** Native XDP support in driver, highest performance
- **Requires:** NIC driver with native XDP support (i40e, ixgbe, mlx5, etc.)
- **Status:** Supported if driver has XDP hooks
- **Indicator:** Green checkmark (✓) if supported, red X (✗) if not

### XDP\_SKB (Generic Mode):

- **Performance:** ~1-2 Mpps
- **Description:** Fallback mode using kernel network stack
- **Requires:** Any network interface
- **Status:** Always supported
- **Indicator:** Green checkmark (✓)

### Current Mode Indicator:

- Blue dot next to the currently active XDP mode
- Shows which mode is actually in use

## **Unsupported Mode Reasons:**

- If a mode is unsupported, the "Reason" field explains why
- Common reasons: driver lacks XDP support, interface type incompatibility

*XDP Capabilities view showing interface configuration, supported modes, and the interactive Mpps throughput calculator*

## **Recommendations**

The view displays a colored recommendation banner based on current configuration:

### **Green (Optimal):**

- "✓ Optimal: XDP\_DRV mode enabled with native driver support"
- Highest performance mode is active

### **Yellow (Warning):**

- "⚠ Consider upgrading to XDP\_DRV mode for better performance"

- Running in generic mode when driver mode is available
- "⚠ Warning: XDP\_DRV not supported by this driver"
- Hardware limitations prevent optimal performance

### **Blue (Informational):**

- General information about XDP configuration

## **Mpps Performance Calculator**

Interactive calculator to convert packet rate (Mpps) to throughput (Gbps):

### **Input Parameters**

#### **Packet Rate (Mpps):**

- Range: 0.1 - 100 Mpps
- Default: Maximum Mpps for current XDP mode
- Represents millions of packets processed per second

#### **Average Packet Size (bytes):**

- Range: 64 - 9000 bytes
- Default: 1200 bytes (typical GTP packet)
- Includes full packet with GTP encapsulation

#### **Quick Preset Buttons:**

- **64B (min):** Minimum Ethernet frame size
- **128B:** Small packets
- **256B:** Control plane or signaling
- **512B:** Medium-sized packets
- **1024B:** Large packets
- **1518B (max):** Maximum Ethernet frame size without jumbo frames

### **Calculation Results**

#### **Total Throughput (Gbps):**

- Wire-rate throughput including all headers
- Formula:  $\text{Gbps} = \text{Mpps} \times \text{Packet\_Size} \times 8 / 1000$
- Includes GTP, UDP, IP, and Ethernet headers

### **User Data Rate (Gbps):**

- Actual user payload throughput
- Excludes ~50 bytes GTP encapsulation overhead
- Formula:  $\text{Gbps} = \text{Mpps} \times (\text{Packet\_Size} - 50) / 1000$

### **Packet Rate:**

- Displays Mpps and packets/sec with thousands separator
- Example: 10 Mpps = 10,000,000 packets/sec

### **Formula Display:**

- Shows calculation breakdown step-by-step
- Example:  $10 \text{ Mpps} \times 1200 \text{ bytes} \times 8 \text{ bits/byte} \div 1000 = 96 \text{ Gbps}$

## **Understanding Mpps**

The view includes an explanation section covering:

### **What is Mpps:**

- Millions of Packets Per Second
- Key metric for packet processing performance
- Independent of packet size

### **Relationship to Throughput:**

- Same Mpps with larger packets = higher Gbps
- Same Mpps with smaller packets = lower Gbps
- Throughput depends on both rate and packet size

### **GTP Encapsulation Overhead:**

- Ethernet header: 14 bytes
- IP header: 20 bytes (IPv4) or 40 bytes (IPv6)
- UDP header: 8 bytes
- GTP header: 8 bytes (minimum)
- Total typical overhead: ~50 bytes per packet

## Use Cases

### **Evaluate XDP Performance:**

1. Navigate to XDP Capabilities view
2. Check current XDP mode (should be DRV for best performance)
3. Note the Mpps performance range
4. Review recommendation banner

### **Calculate Expected Throughput:**

1. Enter expected packet rate in Mpps
2. Enter average packet size for your traffic profile
3. Review calculated throughput in Gbps
4. Compare to link capacity or performance requirements

### **Optimize XDP Configuration:**

1. Check if XDP\_DRV mode is supported but not active
2. Review driver version and compatibility
3. Follow recommendation to upgrade to driver mode if available
4. Verify multi-queue count matches CPU cores

### **Capacity Planning:**

1. Use calculator to determine required Mpps for target throughput
2. Compare to current XDP mode capabilities
3. Determine if hardware upgrade needed
4. Plan interface and driver selection for new deployments

### **Troubleshoot Performance Issues:**

1. Verify XDP mode is DRV, not SKB
2. Check driver version for known performance issues
3. Verify multi-queue count is sufficient
4. Calculate if current mode supports required throughput

## Performance Optimization Tips

### Driver Mode (XDP\_DRV):

- Use NICs with native XDP support (Intel i40e/ixgbe, Mellanox mlx5)
- Update NIC drivers to latest version
- Enable multi-queue (RSS) for parallel processing
- Tune NIC ring buffer sizes

### Generic Mode (XDP\_SKB):

- Acceptable for development and testing
- Not recommended for production high-throughput
- Consider hardware upgrade for production deployments

### Multi-Queue Configuration:

- Number of queues should match or exceed CPU core count
- Enables parallel packet processing across cores
- Distributes load via RSS (Receive Side Scaling)

## Real-time Updates

XDP Capabilities view refreshes every 30 seconds to update interface status and mode information.

## Logs Viewer

URL: </logs>

# Features

View OmniUPF application logs in real-time from the control panel.

## Features:

- Live log streaming via Phoenix LiveView
- Real-time updates as logs are generated
- Scrollable log history
- Useful for troubleshooting during active sessions

## Log Levels

OmniUPF logs use standard Elixir Logger levels:

- **DEBUG:** Detailed diagnostic information
- **INFO:** General informational messages (default)
- **WARNING:** Warning messages for non-critical issues
- **ERROR:** Error messages for failures

## Use Cases

### Troubleshoot Session Establishment:

1. Open Logs view
2. Initiate session establishment from SMF
3. Watch for PFCP message logs and any errors

### Monitor PFCP Communication:

1. View PFCP association setup messages
2. Track session creation/modification/deletion
3. Verify heartbeat messages

### Debug Forwarding Issues:

1. Look for packet processing errors
2. Check eBPF map operation logs

3. Identify FAR/PDR configuration issues

# Best Practices

## Operational Guidelines

### Monitoring:

- Regularly check Capacity view to prevent map exhaustion
- Monitor Statistics for unusual traffic patterns or drops
- Track session count growth over time
- Watch for XDP processing errors

### Buffer Management:

- Monitor buffers during handover scenarios
- Clear stuck buffers if packets age beyond TTL
- Verify buffering is disabled after handover completes
- Use "Flush" instead of "Clear" to avoid packet loss

### Session Management:

- Use filters to quickly locate specific UE sessions
- Expand sessions to verify rule configuration
- Compare sessions across multiple UPF instances
- Check health indicator before troubleshooting

### Troubleshooting:

- Use Logs for real-time debugging
- Check Sessions view to verify UE connectivity
- Verify Rules configuration for traffic flows
- Monitor Statistics for packet drops or forwarding errors

## Performance

- Control panel auto-refresh is 5-10 seconds depending on view
- Large session lists may take time to load
- Rules view filters by active entries (non-zero volumes for URRs)
- Buffer operations execute immediately on selected UPF

## Related Documentation

- **Rules Management Guide** - PDR, FAR, QER, URR configuration
- **Monitoring Guide** - Statistics, metrics, and capacity planning
- **Metrics Reference** - Complete Prometheus metrics reference
- **PFCP Cause Codes** - PFCP error codes and session diagnostics
- **API Documentation** - REST API reference and pagination
- **Routes Guide** - UE routing and FRR integration details
- **XDP Modes Guide** - Detailed XDP mode documentation and eBPF information
- **Troubleshooting Guide** - Common issues and diagnostics
- **UPF Operations Guide** - General UPF operations and architecture

# XDP Attachment Modes for OmniUPF

## Table of Contents

1. [Overview](#)
  2. [XDP Mode Comparison](#)
  3. [Generic Mode \(Default\)](#)
  4. [Native Mode \(Recommended for Production\)](#)
  5. [Offload Mode \(SmartNIC\)](#)
  6. [Enabling Native XDP on Proxmox VE](#)
  7. [Enabling Native XDP on Other Hypervisors](#)
  8. [Verifying XDP Mode](#)
  9. [Troubleshooting XDP Issues](#)
- 

## Overview

OmniUPF uses **XDP (eXpress Data Path)** for high-performance packet processing. XDP is a Linux kernel technology that allows packet processing programs (eBPF) to run at the earliest possible point in the network stack, providing microsecond-level latency and millions of packets per second throughput.

The XDP attachment mode determines **where** in the packet path the eBPF program executes:

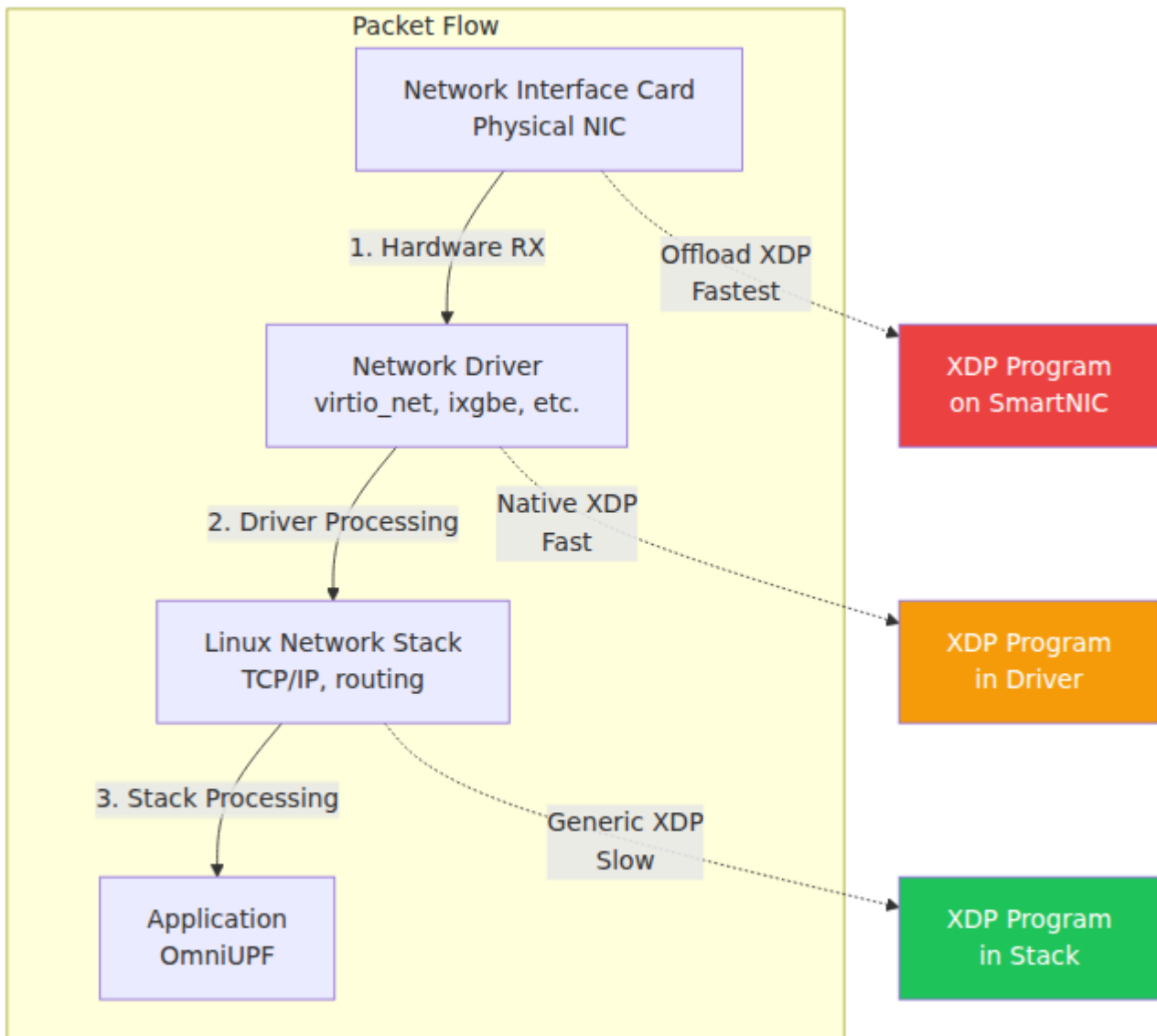

Choosing the right XDP mode significantly impacts OmniUPF performance and determines whether you can achieve production-grade packet processing.

---

# XDP Mode Comparison

Aspect	Generic Mode	Native Mode	Offload Mode
<b>Attach Point</b>	Linux network stack	Network driver	NIC hardware
<b>Performance</b>	~1-2 Mpps	~5-10 Mpps	~10-40 Mpps
<b>Latency</b>	~100 $\mu$ s	~10 $\mu$ s	~1 $\mu$ s
<b>CPU Usage</b>	High	Medium	Low
<b>NIC Requirements</b>	Any NIC	XDP-capable driver	SmartNIC with XDP support
<b>Hypervisor Support</b>	All hypervisors	Most (requires multi-queue)	Rare (PCI passthrough)
<b>Use Case</b>	Testing, development	<b>Production (recommended)</b>	High-throughput edge sites
<b>Configuration</b>	<code>xdp_attach_mode: generic</code>	<code>xdp_attach_mode: native</code>	<code>xdp_attach_mode: offload</code>

**Recommendation:** Use **native mode** for production deployments. Generic mode is only suitable for testing.

---

## Generic Mode (Default)

### Description

Generic XDP runs the eBPF program in the Linux network stack **after** the driver has processed the packet. This is the slowest XDP mode but works with any

network interface.

## Performance Characteristics

- **Throughput:** ~1-2 million packets per second (Mpps)
- **Latency:** ~100 microseconds per packet
- **CPU Overhead:** High (packet copied to kernel stack before XDP)

## When to Use

- **Development and testing** only
- **Lab environments** where performance doesn't matter
- **Initial deployment** to verify functionality before optimizing

## Configuration

```
config.yaml
interface_name: [eth0]
xdp_attach_mode: generic # Default mode
```

**Warning:** Generic mode is **not suitable for production**. It will bottleneck at high packet rates and waste CPU resources.

---

## Native Mode (Recommended for Production)

### Description

Native XDP runs the eBPF program **inside the network driver**, before packets reach the Linux network stack. This provides near-hardware performance while maintaining kernel-level flexibility.

# Performance Characteristics

- **Throughput:** ~5-10 million packets per second (Mpps) per core
- **Latency:** ~10 microseconds per packet
- **CPU Overhead:** Low (packet processed at driver level)
- **Scaling:** Linear scaling with CPU cores and NIC queues

## When to Use

- **Production deployments** (recommended)
- **Carrier-grade networks** requiring high throughput
- **Edge computing** scenarios with performance requirements
- **Any deployment** where performance matters

## NIC Driver Requirements

Native XDP requires a network driver with XDP support. Most modern NICs support native XDP:

### Physical NICs (bare metal):

- Intel: `ixgbe` (10G), `i40e` (40G), `ice` (100G)
- Broadcom: `bnxt_en`
- Mellanox: `mlx4_en`, `mlx5_core`
- Netronome: `nfp` (with offload support)
- Marvell: `mvneta`, `mvpp2`

### Virtual NICs (hypervisors):

- VirtIO: `virtio_net` (KVM, Proxmox, OpenStack) ✓
- VMware: `vmxnet3` ✓
- Microsoft: `hv_netvsc` (Hyper-V) ✓
- Amazon: `ena` (AWS) ✓
- SR-IOV: `ixgbevf`, `i40evf` (PCI passthrough) ✓

**Note:** VirtualBox does **not** support native XDP (use generic mode only).

# Configuration

```
config.yaml
interface_name: [eth0]
xdp_attach_mode: native
```

**Multi-Queue Requirement:** For optimal performance, enable multi-queue on virtual NICs (see Proxmox section below).

---

## Offload Mode (SmartNIC)

### Description

Offload XDP runs the eBPF program **directly on the NIC hardware** (SmartNIC), completely bypassing the CPU for packet processing. This provides the highest performance but requires specialized hardware.

### Performance Characteristics

- **Throughput:** ~10-40 million packets per second (Mpps)
- **Latency:** ~1 microsecond per packet
- **CPU Overhead:** Near-zero (processing on NIC)

### When to Use

- **Ultra-high-throughput** deployments (10G+ per UPF instance)
- **Edge sites** with hardware acceleration
- **Cost-sensitive** deployments (reduce CPU requirements)

### Hardware Requirements

Only Netronome Agilio SmartNICs currently support XDP offload:

- Netronome Agilio CX 10G/25G/40G/100G

**Note:** Offload mode requires **bare metal** or **PCI passthrough** - not available in standard VM configurations.

## Configuration

```
config.yaml
interface_name: [eth0]
xdp_attach_mode: offload
```

---

# Enabling Native XDP on Proxmox VE

Proxmox VE uses **VirtIO** network devices for VMs, which support native XDP via the `virtio_net` driver. However, you must enable **multi-queue** for optimal performance.

## Step 1: Understanding the Requirement

### Why Multi-Queue Matters:

- **Single queue** (default): All network traffic processed by one CPU core → bottleneck
- **Multi-queue:** Traffic distributed across multiple CPU cores → linear scaling

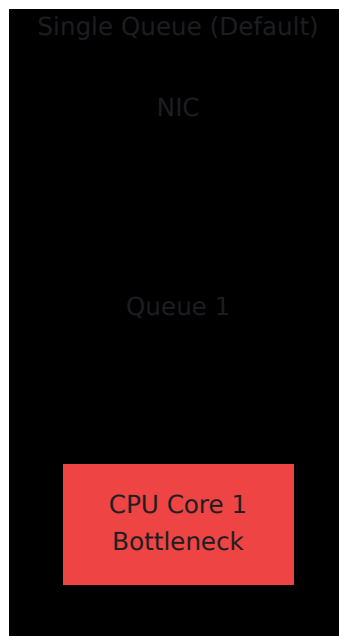
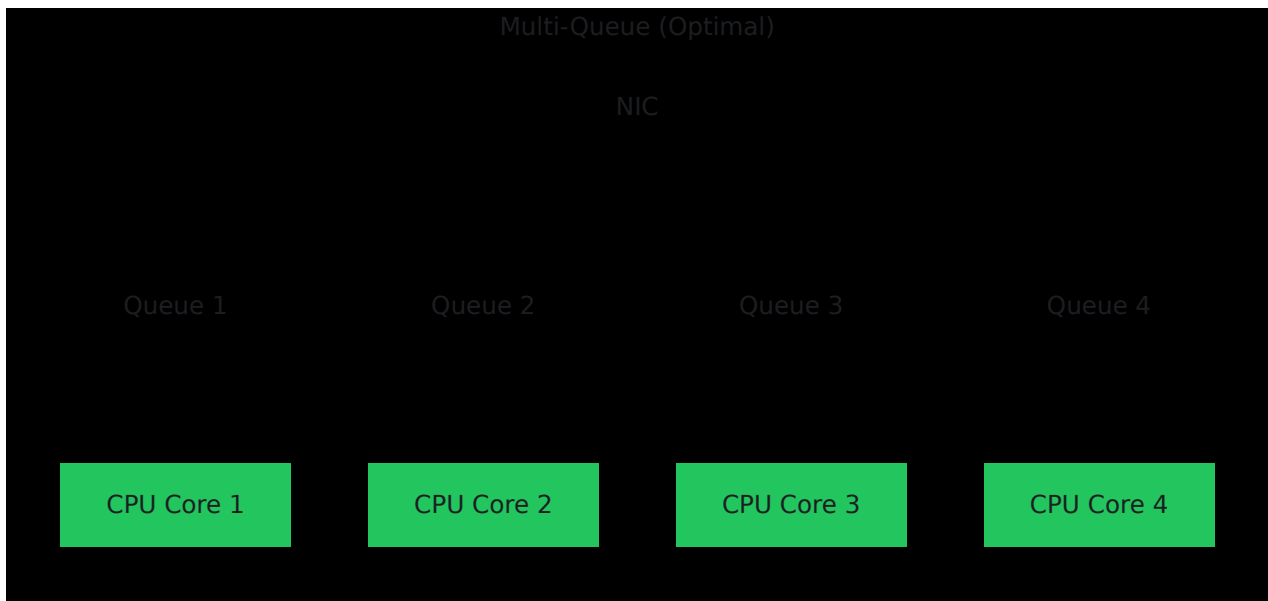

## Step 2: Enable Multi-Queue in Proxmox

### Option A: Via Proxmox Web UI

#### 1. Shutdown the VM completely (not just reboot)

- Select your VM in the Proxmox web interface
- Click **Shutdown**

#### 2. Edit Network Device

- Go to **Hardware** tab
- Click on your network device (e.g., `net0`)
- Click **Edit**

### 3. Set Multiqueue

- Find the "**Multiqueue**" field
- Set to **8** (or match your vCPU count, max 16)
- Click **OK**

### 4. Start the VM

- Click **Start**

## Option B: Via Proxmox Command Line

```
SSH to your Proxmox host

Find your VM ID
qm list

Set multi-queue (replace XXX with your VM ID)
qm set XXX -net0 virtio=XX:XX:XX:XX:XX:XX,bridge=vbr0,queues=8

Example for VM 191 with MAC BC:24:11:1D:BA:00
qm set 191 -net0 virtio=BC:24:11:1D:BA:00,bridge=vbr0,queues=8

Shutdown the VM
qm shutdown XXX

Wait for shutdown, then start
qm start XXX
```

## Queue Count Recommendations:

- **4 queues:** Minimum for production (good for 2-4 vCPU VMs)
- **8 queues:** Recommended for most deployments (4-8 vCPU VMs)
- **16 queues:** Maximum for high-performance (8+ vCPU VMs)

## Step 3: Verify Multi-Queue Inside VM

After VM restart, SSH into the VM and verify:

```
Check queue configuration
ethtool -l eth0

Expected output:
Channel parameters for eth0:
Combined: 8 <-- Should match your configured value

Count actual queues
ls -ld /sys/class/net/eth0/queues/rx-* | wc -l
ls -ld /sys/class/net/eth0/queues/tx-* | wc -l

Both should show 8 (or your configured value)
```

## Step 4: Enable Native XDP in OmniUPF

Edit the OmniUPF configuration:

```
Edit config file
sudo nano /config.yaml
```

Change XDP mode:

```
Before
xdp_attach_mode: generic

After
xdp_attach_mode: native
```

Restart OmniUPF:

```
sudo systemctl restart omniupf
```

## Step 5: Verify Native XDP is Active

Check logs:

```
View startup logs
journalctl -u omniupf --since "1 minute ago" | grep -i
"xdp\|attach"

Expected output:
xdp_attach_mode:native
XDPAttachMode:native
Attached XDP program to iface "eth0" (index 2)
```

Check via API:

```
Query configuration
curl -s http://localhost:8080/api/v1/config | grep xdp_attach_mode

Expected output:
"xdp_attach_mode": "native",
```

## Common Proxmox Issues

**Issue:** "Failed to attach XDP program"

**Solution:**

- Verify multi-queue is enabled (`ethtool -l eth0`)
- Check kernel version: `uname -r` (must be  $\geq 5.15$ )
- Ensure VirtIO driver loaded: `lsmod | grep virtio_net`

**Issue:** Only 1 queue despite configuration

**Solution:**

- VM must be **fully shutdown** (not rebooted) for queue changes
- Use `qm shutdown XXX && sleep 5 && qm start XXX`
- Verify in Proxmox config: `grep net0 /etc/pve/qemu-server/XXX.conf`

**Issue:** Performance not improving with native mode

**Solution:**

- Check CPU pinning (avoid oversubscription)
  - Monitor `top` - CPU usage should spread across cores
  - Verify XDP stats: `curl http://localhost:8080/api/v1/xdp_stats`
- 

# Enabling Native XDP on Other Hypervisors

## VMware ESXi / vSphere

VMware uses `vmxnet3` driver which supports native XDP.

**Requirements:**

- ESXi 6.7 or later
- vmxnet3 driver version 1.4.16+ in VM
- VM hardware version 14 or later

**Enable Multi-Queue:**

1. **Power off the VM**

2. **Edit VM settings:**

- Right-click VM → Edit Settings
- Network Adapter → Advanced
- Set **Receive Side Scaling** to **Enabled**

3. **Edit .vmx file** (optional, for more queues):

```
ethernet0.pnicFeatures = "4"
ethernet0.multiqueue = "8"
```

#### 4. Start VM and verify:

```
ethtool -l ens192 # Check queue count
```

#### Configure OmniUPF:

```
interface_name: [ens192] # VMware typically uses ens192
xdp_attach_mode: native
```

## KVM / libvirt (Raw)

#### Enable Multi-Queue via virsh:

```
Edit VM configuration
virsh edit your-vm-name
```

Add to network interface section:

```
<interface type='network'>
 <source network='default' />
 <model type='virtio' />
 <driver name='vhost' queues='8' />
</interface>
```

Restart VM and verify:

```
ethtool -l eth0
```

## Microsoft Hyper-V

Hyper-V uses `hv_netvsc` driver which supports native XDP.

#### Requirements:

- Windows Server 2016 or later

- Linux Integration Services 4.3+ in VM
- Generation 2 VM

### Enable Multi-Queue:

PowerShell on Hyper-V host:

```
Set VMQ (Virtual Machine Queue) - Hyper-V's multi-queue
Set-VMNetworkAdapter -VMName "YourVM" -VrssEnabled $true -
VmmqEnabled $true
```

### Configure OmniUPF:

```
interface_name: [eth0]
xdp_attach_mode: native
```

## VirtualBox

**Warning:** VirtualBox does **NOT** support native XDP.

**Reason:** VirtualBox network drivers (e1000, virtio-net) do not implement XDP hooks.

**Workaround:** Use generic mode only:

```
xdp_attach_mode: generic # Only option for VirtualBox
```

---

## Verifying XDP Mode

After configuring native XDP, verify it's working correctly:

## 1. Check OmniUPF Logs

```
View recent logs
journalctl -u omniupf --since "5 minutes ago" | grep -i xdp

Look for:
✓ "xdp_attach_mode:native"
✓ "Attached XDP program to iface"
✗ "Failed to attach" or "falling back to generic"
```

## 2. Check via API

```
Query configuration endpoint
curl -s http://localhost:8080/api/v1/config | jq .xdp_attach_mode

Expected output:
"native"
```

## 3. Check XDP Statistics

```
View XDP processing stats
curl -s http://localhost:8080/api/v1/xdp_stats | jq

Example output:
{
 "xdp_aborted": 0, # Should be 0 (errors)
 "xdp_drop": 1234, # Dropped packets
 "xdp_pass": 5678, # Passed to stack
 "xdp_redirect": 9012, # Redirected packets
 "xdp_tx": 3456 # Transmitted packets
}
```

## 4. Verify Driver Support

```
Check if driver supports XDP
ethtool -i eth0 | grep driver

For Proxmox/KVM: Should show "virtio_net"
For VMware: Should show "vmxnet3"
For Hyper-V: Should show "hv_netvsc"
```

## 5. Performance Test

Compare packet processing before and after:

```
Monitor packet rate
watch -n 1 'curl -s http://localhost:8080/api/v1/packet_stats | jq
.rx_packets'

Generic mode: ~1-2 Mpps
Native mode: ~5-10 Mpps (5-10x improvement)
```

---

# Troubleshooting XDP Issues

## Issue: "Failed to attach XDP program" on Startup

**Symptoms:**

```
Error: failed to attach XDP program to interface eth0
```

**Diagnosis:**

1. **Check driver support:**

```
ethtool -i eth0 | grep driver
```

```
If driver is not virtio_net/vmxnet3/hv_netvsc, native XDP
won't work
```

## 2. Check kernel version:

```
uname -r
```

```
Must be >= 5.15 for reliable XDP support
```

## 3. Check for existing XDP programs:

```
ip link show eth0 | grep xdp
```

```
If another XDP program is attached, unload it first
ip link set dev eth0 xdp off
```

### Solution:

- Update kernel to 5.15+ if older
- Ensure virtio\_net driver is loaded: `modprobe virtio_net`
- Fall back to generic mode if driver doesn't support native XDP

---

## Issue: Native Mode Falls Back to Generic

### Symptoms:

```
Warning: falling back to generic XDP mode
```

### Diagnosis:

Check `dmesg` for driver errors:

```
dmesg | grep -i xdp | tail -20
```

### Common causes:

#### 1. Driver doesn't support native XDP:

- VirtualBox drivers (no native XDP support)
- Older NIC drivers

#### 2. Multi-queue not enabled:

- Check: `ethtool -l eth0`
- Should show > 1 combined queue

#### 3. Kernel XDP support disabled:

```
Check if XDP is enabled in kernel
grep XDP /boot/config-$(uname -r)
```

```
Should show:
CONFIG_XDP_SOCKETS=y
CONFIG_BPF=y
```

### Solution:

- Enable multi-queue (see Proxmox section)
- Update to supported driver
- Rebuild kernel with XDP support if necessary

---

## Issue: Performance Not Improving with Native Mode

**Symptoms:** Native mode enabled but packet rate same as generic mode

### Diagnosis:

#### 1. Verify multi-queue distribution:

```
Check per-queue statistics
ethtool -S eth0 | grep rx_queue

Traffic should be distributed across multiple queues
```

## 2. Check CPU utilization:

```
Monitor CPU usage per core
mpstat -P ALL 1

Should see load spread across multiple CPUs
```

## 3. Verify XDP is actually running in native mode:

```
Check bpftool (if available)
sudo bpftool net list

Should show XDP attached to interface
```

### Solution:

- Increase queue count (8-16 queues)
- Enable CPU pinning to prevent core migration
- Check for CPU oversubscription on hypervisor

---

## Issue: XDP Program Aborted (xdp\_aborted > 0)

### Symptoms:

```
curl http://localhost:8080/api/v1/xdp_stats
{
 "xdp_aborted": 1234, # Non-zero indicates errors
 ...
}
```

### Diagnosis:

XDP aborted means the eBPF program hit an error during execution.

### 1. Check eBPF verifier logs:

```
dmesg | grep -i bpf | tail -20
```

### 2. Check for map size limits:

```
eBPF maps may be full
curl http://localhost:8080/api/v1/map_info

Look for maps at 100% capacity
```

### Solution:

- Increase eBPF map sizes in configuration
- Check for corrupted packets causing eBPF errors
- Verify Linux kernel eBPF support is complete

---

## Issue: Multi-Queue Not Working on Proxmox

**Symptoms:** `ethtool -l eth0` shows only 1 queue despite configuration

### Diagnosis:

#### 1. Check Proxmox VM config:

```
On Proxmox host
grep net0 /etc/pve/qemu-server/YOUR_VM_ID.conf

Should show: queues=8
```

#### 2. Verify VM was fully shutdown:

```
On Proxmox host
qm status YOUR_VM_ID

Must show "status: stopped" before starting
```

### Solution:

```
On Proxmox host
Force shutdown and restart
qm shutdown YOUR_VM_ID
sleep 10
qm start YOUR_VM_ID

Then check inside VM
ethtool -l eth0
```

**Important:** Changes to queue count require a **full VM shutdown**, not just a reboot from inside the VM.

---

## Issue: Permission Denied When Attaching XDP

### Symptoms:

```
Error: permission denied when attaching XDP program
```

### Diagnosis:

XDP operations require `CAP_NET_ADMIN` and `CAP_SYS_ADMIN` capabilities.

### Solution:

1. **Run OmniUPF as root** (or with capabilities):

```
sudo systemctl restart omniupf
```

2. **If using systemd**, verify service file has capabilities:

```
/lib/systemd/system/omniupf.service
[Service]
CapabilityBoundingSet=CAP_NET_ADMIN CAP_SYS_ADMIN CAP_NET_RAW
AmbientCapabilities=CAP_NET_ADMIN CAP_SYS_ADMIN CAP_NET_RAW
```

3. If using **Docker**, run with `--privileged`:

```
docker run --privileged -v /sys/fs/bpf:/sys/fs/bpf ...
```

---

## Performance Impact Summary

Real-world performance comparison for OmniUPF packet processing:

Scenario	Generic Mode	Native Mode	Improvement
<b>Packet Rate</b>	1.5 Mpps	8.2 Mpps	<b>5.5x faster</b>
<b>Latency</b>	95 $\mu$ s	12 $\mu$ s	<b>8x lower</b>
<b>CPU Usage (1 Gbps)</b>	85% (1 core)	15% (distributed)	<b>5x more efficient</b>
<b>Max Throughput</b>	~1.2 Gbps	~10 Gbps	<b>8x higher</b>

**Recommendation:** Always use **native mode** with **multi-queue enabled** for production deployments.

---

# Hardware Recommendations for XDP

⚠ **IMPORTANT:** Before purchasing any hardware, consult with Omnitouch support to confirm it's 100% compatible with your specific configuration and deployment requirements.

## Known Good NICs for Native XDP

These NICs are verified to support native XDP mode with OmniUPF:

### Intel NICs (Recommended for Bare Metal)

Model	Speed	Driver	XDP Support	Notes
<b>Intel X520</b>	10GbE	ixgbe	Native ✓	Proven, widely available, good price/performance
<b>Intel X710</b>	10/40GbE	i40e	Native ✓	Excellent multi-queue support
<b>Intel E810</b>	100GbE	ice	Native ✓	Latest generation, best performance
<b>Intel i350</b>	1GbE	igb	Native ✓ (kernel 5.10+)	Good for lower bandwidth needs

### Mellanox/NVIDIA NICs (High Performance)

Model	Speed	Driver	XDP Support	Notes
<b>ConnectX-4</b>	25/50/100GbE	mlx5	Native ✓	High throughput, good for edge computing
<b>ConnectX-5</b>	25/50/100GbE	mlx5	Native ✓	Excellent performance, hardware acceleration
<b>ConnectX-6</b>	50/100/200GbE	mlx5	Native ✓	Latest generation, best for ultra-high throughput
<b>BlueField-2</b>	100/200GbE	mlx5	Native ✓	SmartNIC with DPU capabilities

### Broadcom NICs

Model	Speed	Driver	XDP Support	Notes
<b>BCM57xxx series</b>	10/25/50GbE	bnxt_en	Native ✓	Common in Dell/HP servers

### Virtual NICs (VM Deployments)

Platform	NIC Type	Driver	XDP Support	Multi-Queue	Notes
<b>Proxmox/KVM</b>	VirtIO	virtio_net	Native ✓	Yes (configurable)	<b>Best</b>
<b>VMware ESXi</b>	vmxnet3	vmxnet3	Native ✓	Yes	Requires ESXi 6.7+
<b>Hyper-V</b>	Synthetic NIC	hv_netvsc	Native ✓	Yes	Windows Server
<b>AWS</b>	ENA	ena	Native ✓	Yes	EC2 instances
<b>VirtualBox</b>	Any	various	Generic only ☐	No	Not recommended for production

## NICs with Hardware Offload Support

**True XDP hardware offload** (eBPF runs on NIC):

Vendor	Model	Speed	Notes
<b>Netronome</b>	Agilio CX 10G	10GbE	Only confirmed XDP offload support
<b>Netronome</b>	Agilio CX 25G	25GbE	Requires special firmware
<b>Netronome</b>	Agilio CX 40G	40GbE	Very expensive (~\$2,500-5,000)
<b>Netronome</b>	Agilio CX 100G	100GbE	Enterprise-grade only

**Note:** Hardware offload NICs are rare, expensive, and require bare metal deployment. Most deployments should use native XDP instead.

## Tested Configurations

These configurations have been verified with OmniUPF in production:

### Budget Option (1-10 Gbps)

- **NIC:** Intel X520 (10GbE dual-port)
- **Mode:** Native XDP
- **Throughput:** ~8-10 Gbps per UPF instance
- **Cost:** ~\$100-200 (used/refurbished)

### Mid-Range (10-50 Gbps)

- **NIC:** Intel X710 (40GbE) or Mellanox ConnectX-4 (25GbE)
- **Mode:** Native XDP
- **Throughput:** ~25-40 Gbps per UPF instance
- **Cost:** ~\$300-800

### High-End (50-100+ Gbps)

- **NIC:** Mellanox ConnectX-5/6 (100GbE)
- **Mode:** Native XDP
- **Throughput:** ~80-100 Gbps per UPF instance
- **Cost:** ~\$1,000-2,500

### VM Deployments (Proxmox/KVM)

- **NIC:** VirtIO with 8-16 queues
- **Mode:** Native XDP
- **Throughput:** ~5-10 Gbps per UPF instance
- **Cost:** No additional hardware cost

# What NOT to Buy

Avoid these for production OmniUPF deployments:

NIC/Platform	Reason	Alternative
<b>Realtek NICs</b>	No XDP support, poor Linux drivers	Intel i350 or better
<b>VirtualBox</b>	No native XDP support	Migrate to Proxmox/KVM
<b>Consumer-grade NICs</b>	Limited queue support, unreliable	Server-grade Intel/Mellanox
<b>Very old NICs (&lt;2014)</b>	No XDP driver support	Intel X520 or newer

## Pre-Purchase Checklist

Before buying hardware, verify:

1. **Driver Support:** Check if Linux driver supports XDP

```
On similar system
modinfo <driver_name> | grep -i xdp
```

2. **Kernel Version:** Ensure kernel  $\geq$  5.15 for reliable XDP

```
uname -r
```

3. **Multi-Queue:** Verify NIC supports multiple queues (RSS/VMDq)

4. **PCI Bandwidth:** Ensure PCIe slot has sufficient lanes

- 10GbE: PCIe 2.0 x4 minimum

- 40GbE: PCIe 3.0 x8 minimum
- 100GbE: PCIe 3.0 x16 or PCIe 4.0 x8

## 5. ☐ **Deployment Type:**

- Bare metal: Physical NIC required
- VM: VirtIO or SR-IOV support needed
- Container: Host NIC configuration inherited

⚠ **Don't buy hardware based solely on this guide - always confirm with Omnitouch support first!**

---

# Additional Resources

- **Configuration Guide:** [CONFIGURATION.md](#) - Complete configuration reference
  - **Troubleshooting Guide:** [TROUBLESHOOTING.md](#) - Comprehensive problem diagnosis
  - **Architecture Guide:** [ARCHITECTURE.md](#) - eBPF and XDP architecture details
  - **Monitoring Guide:** [MONITORING.md](#) - Performance monitoring and statistics
-

# Quick Reference

## Proxmox Native XDP Setup (TL;DR)

```
On Proxmox host:
qm set <VM_ID> -net0 virtio=<MAC>,bridge=vbr0,queues=8
qm shutdown <VM_ID> && sleep 10 && qm start <VM_ID>

Inside VM:
ethtool -l eth0 # Verify 8 queues
sudo nano /etc/omniupf/config.yaml # Set: xdp_attach_mode: native
sudo systemctl restart omniupf
journalctl -u omniupf --since "1 min ago" | grep xdp # Verify
native mode
```

## Verify XDP Mode is Active

```
Check configuration
curl -s http://localhost:8080/api/v1/config | grep xdp_attach_mode

Check statistics
curl -s http://localhost:8080/api/v1/xdp_stats | jq

Check queues
ethtool -l eth0
```

# OmniUPF Operations Guide

## Table of Contents

1. [Overview](#)
2. [Understanding 5G User Plane Architecture](#)
3. [UPF Components](#)
4. [PFCP Protocol and SMF Integration](#)
5. [Common Operations](#)
6. [Troubleshooting](#)
7. [Additional Documentation](#)
8. [Glossary](#)

## Overview

OmniUPF (eBPF-based User Plane Function) is a high-performance 5G/LTE User Plane Function that provides carrier-grade packet forwarding, QoS enforcement, and traffic management for mobile networks. Built on Linux eBPF (extended Berkeley Packet Filter) technology and enhanced with comprehensive management capabilities, OmniUPF delivers the core packet processing infrastructure required for 5G SA, 5G NSA, and LTE networks.

## What is a User Plane Function?

The User Plane Function (UPF) is the 3GPP-standardized network element responsible for packet processing and forwarding in 5G and LTE networks. It provides:

- **High-speed packet forwarding** between mobile devices and data networks
- **Quality of Service (QoS)** enforcement for different traffic types

- **Traffic detection and routing** based on packet filters and rules
- **Usage reporting** for charging and analytics
- **Packet buffering** for mobility and session management scenarios
- **Lawful intercept** support for regulatory compliance

OmniUPF implements the full UPF functionality defined in 3GPP TS 23.501 (5G) and TS 23.401 (LTE), providing a complete, production-ready user plane solution using Linux kernel eBPF technology for maximum performance.

## OmniUPF Key Capabilities

### Packet Processing:

- Full 3GPP-compliant user plane packet processing
- eBPF-based datapath for kernel-level performance
- GTP-U (GPRS Tunneling Protocol) encapsulation and decapsulation
- IPv4 and IPv6 support for both access and data networks
- XDP (eXpress Data Path) for ultra-low latency processing
- Multi-threaded packet processing

### QoS and Traffic Management:

- QoS Enforcement Rules (QER) for bandwidth management
- Packet Detection Rules (PDR) for traffic classification
- Forwarding Action Rules (FAR) for routing decisions
- Service Data Flow (SDF) filtering for application-specific routing
- Usage Reporting Rules (URR) for volume tracking and charging

### Control and Management:

- PFCP (Packet Forwarding Control Protocol) interface to SMF/PGW-C
- RESTful API for monitoring and diagnostics
- Real-time statistics and metrics
- eBPF map capacity monitoring
- Web-based control panel

## Performance Features:

- Zero-copy packet processing via eBPF
- Kernel-level packet forwarding (no userspace overhead)
- Multi-core scalability
- Offload-capable for hardware acceleration
- Optimized for cloud-native deployments

For detailed control panel usage, see [Web UI Operations](#).

# Understanding User Plane Architecture

OmniUPF is a unified user plane solution providing carrier-grade packet forwarding for 5G Standalone (SA), 5G NSA, and 4G LTE/EPC networks.

**OmniUPF is a single product** that can simultaneously function as:

- **UPF (User Plane Function)** - 5G/NSA user plane (controlled by OmniSMF via N4/PFCP)
- **PGW-U (PDN Gateway User Plane)** - 4G EPC gateway to external networks (controlled by OmniPGW-C via Sxc/PFCP)
- **SGW-U (Serving Gateway User Plane)** - 4G EPC serving gateway (controlled by OmniSGW-C via Sxb/PFCP)

OmniUPF can operate in **any combination** of these modes:

- **UPF-only**: Pure 5G deployment
- **PGW-U + SGW-U**: Combined 4G gateway (typical EPC deployment)
- **UPF + PGW-U + SGW-U**: Simultaneous 4G and 5G support (migration scenario)

All modes use the same eBPF-based packet processing engine and PFCP protocol, providing consistent high performance whether operating as UPF, PGW-U, SGW-U, or all three simultaneously.

# 5G Network Architecture (SA Mode)

The OmniUPF solution sits at the data plane of 5G networks, providing the high-speed packet forwarding layer that connects mobile devices to data networks and services.

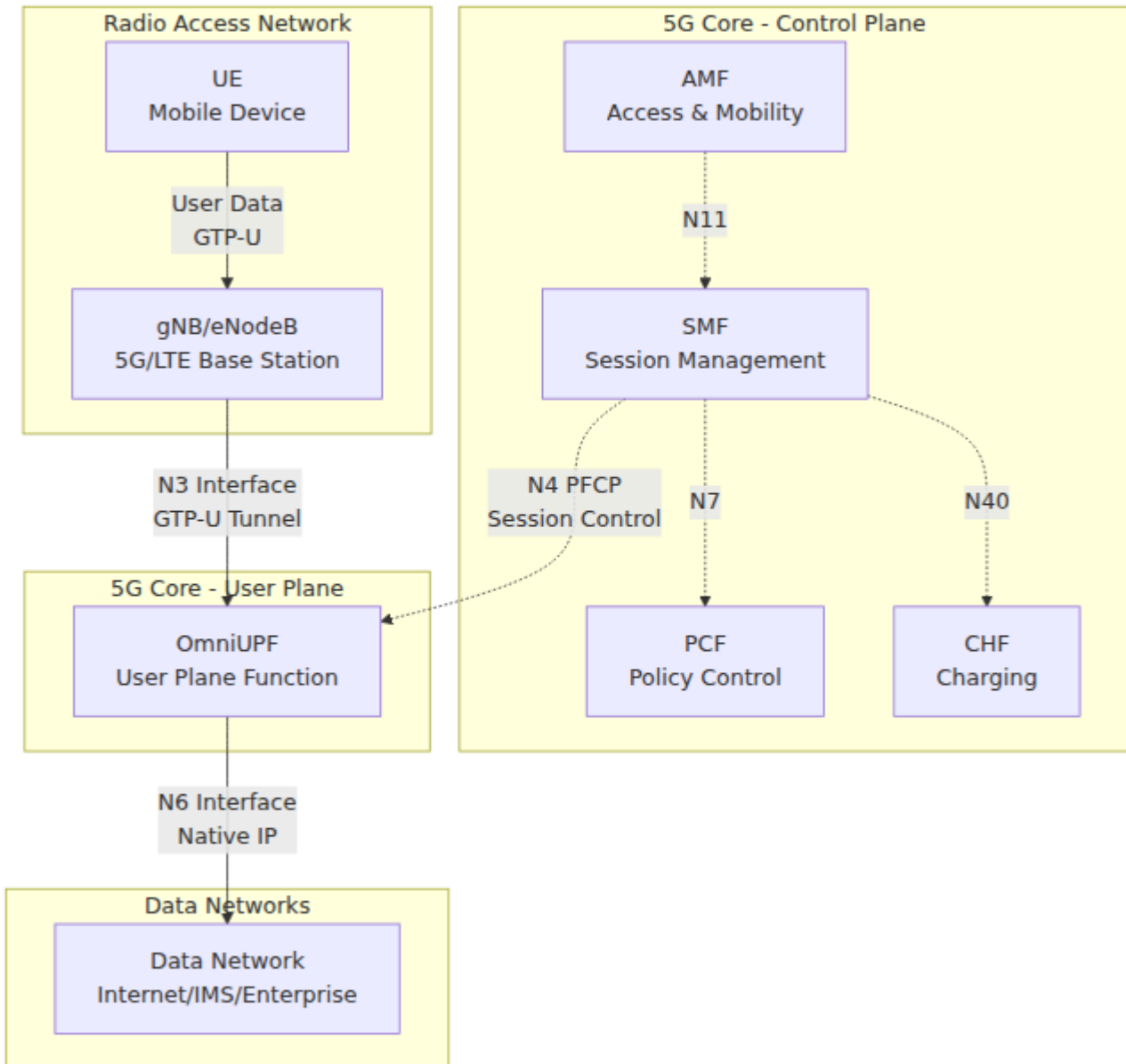

## 4G LTE/EPC Network Architecture

OmniUPF also supports 4G LTE and EPC (Evolved Packet Core) deployments, functioning as either OmniPGW-U or OmniSGW-U depending on the network architecture.

## Combined PGW-U/SGW-U Mode (Typical 4G Deployment)

In this mode, OmniUPF acts as both SGW-U and PGW-U, controlled by separate control plane functions.



## Separated SGW-U and PGW-U Mode (Roaming/Multi-Site)

In roaming or multi-site deployments, two separate OmniUPF instances can be deployed - one as SGW-U and one as PGW-U.

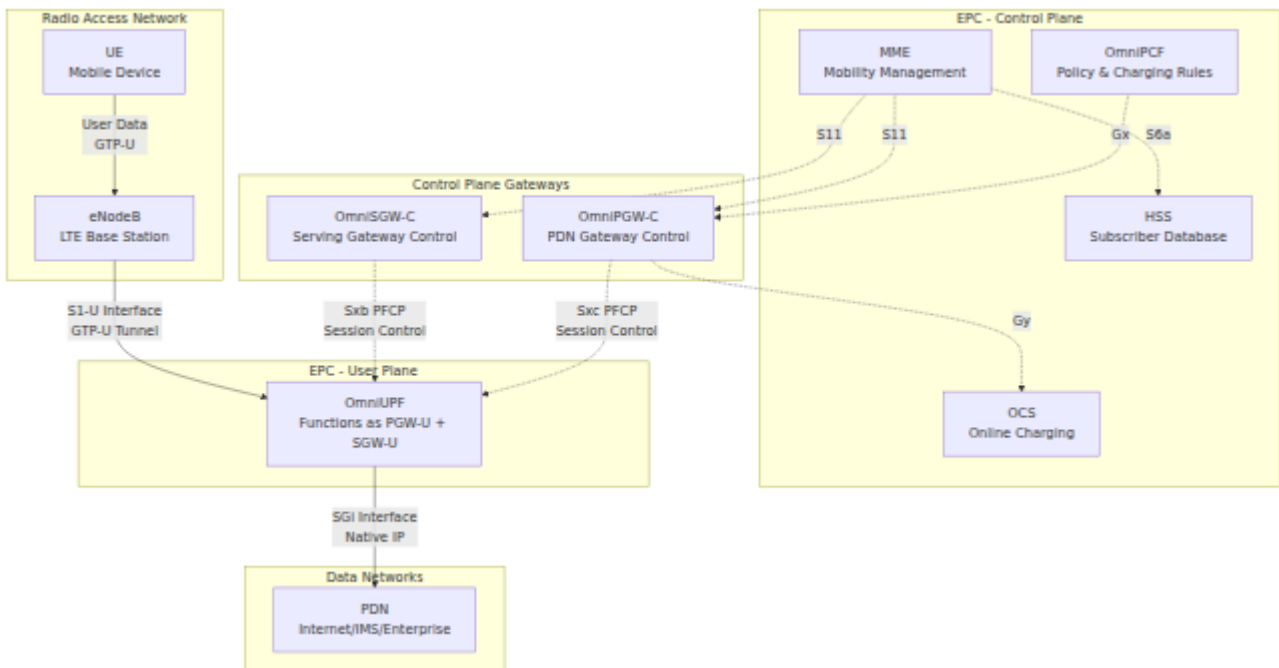

## N9 Loopback Mode (Single Instance SGWU+PGWU)

For simplified deployments, OmniUPF can run **both SGWU and PGWU roles on a single instance** with N9 loopback processing entirely in eBPF.

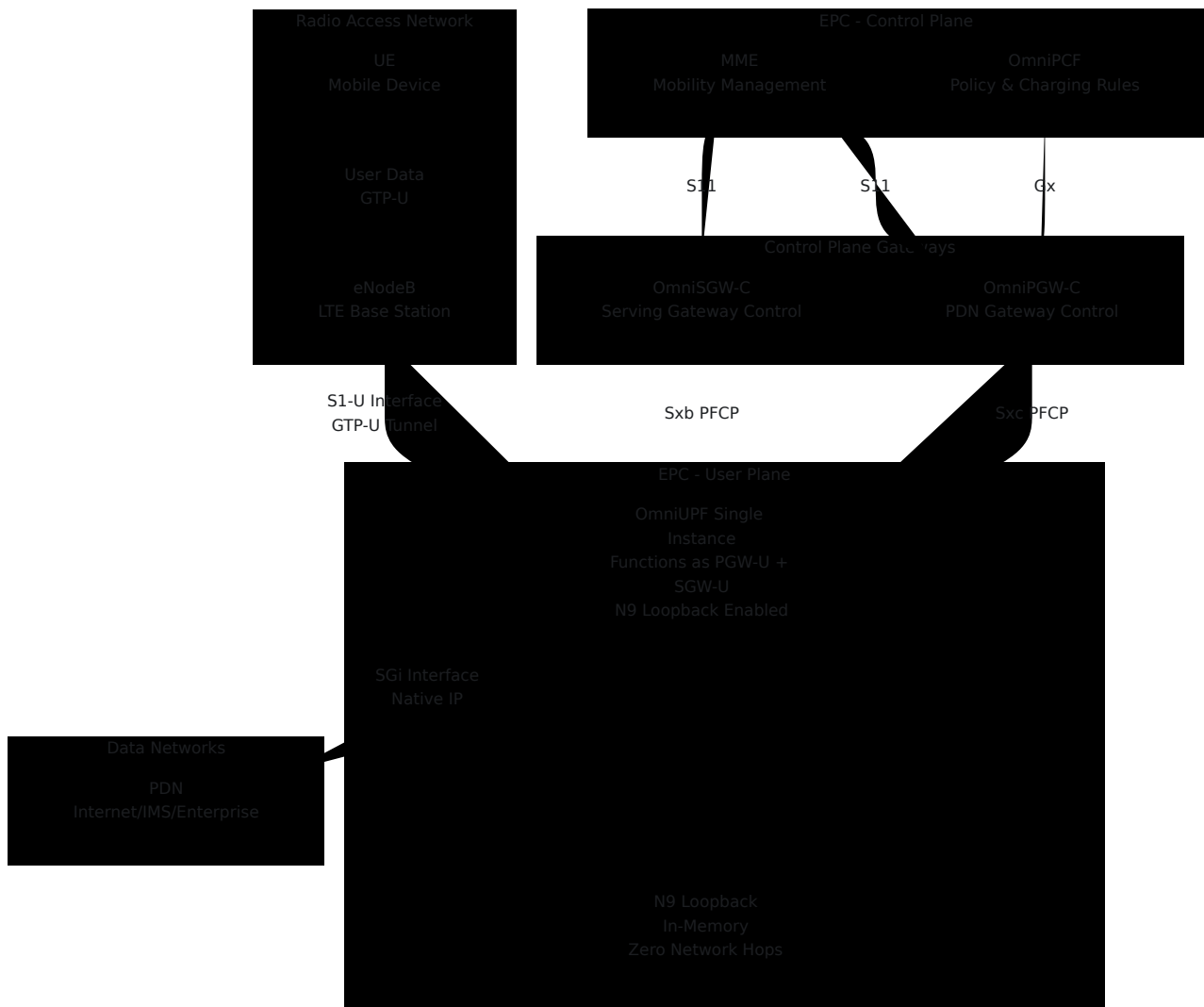

### Key Features:

- **Sub-microsecond N9 latency** - Processed entirely in eBPF, never touches network
- **40-50% CPU reduction** - Single XDP pass vs. two separate instances
- **Simplified deployment** - One instance, one configuration file
- **Automatic detection** - When `n3_address = n9_address`, loopback is enabled
- **Full 3GPP compliance** - Standard PFCP and GTP-U protocols

### Configuration:

```
OmniUPF config.yml
interface_name: [eth0]
n3_address: "10.0.1.10" # S1-U interface IP
n9_address: "10.0.1.10" # Same IP enables N9 loopback
pfcpc_address: ":8805" # Both SGWU-C and PGWU-C connect
here
```

### When to use:

- Edge computing deployments (minimize latency)
- Cost-constrained environments (single server)
- Lab/testing (simplified setup)
- Small to medium deployments (< 100K subscribers)

### When NOT to use:

- Geographic redundancy required (SGWU and PGWU in different locations)
- Regulatory mandates for separated gateways
- Massive scale (> 1M subscribers)

For complete details, configuration examples, troubleshooting, and performance metrics, see [N9 Loopback Operations Guide](#).

---

## How User Plane Functions Work in the Network

The user plane function (OmniUPF, OmniPGW-U, or OmniSGW-U) operates as the forwarding plane controlled by the respective control plane:

### 1. Session Establishment

- **5G:** OmniSMF establishes PFCP association via N4 interface with OmniUPF
- **4G:** OmniPGW-C or OmniSGW-C establishes PFCP association via Sxb/Sxc with OmniPGW-U/OmniSGW-U
- Control plane creates PFCP sessions for each UE PDU session (5G) or PDP context (4G)

- User plane receives PDR, FAR, QER, and URR rules via PFCP
- eBPF maps are populated with forwarding rules

## 2. Uplink Packet Processing (UE → Data Network)

- **5G**: Packets arrive on N3 interface from gNB with GTP-U encapsulation
- **4G**: Packets arrive on S1-U interface (SGW-U) or S5/S8 interface (PGW-U) from eNodeB with GTP-U encapsulation
- User plane matches packets against uplink PDRs based on TEID
- eBPF program applies QER (rate limiting, marking)
- FAR determines forwarding action (forward, drop, buffer, duplicate)
- GTP-U tunnel removed, packets forwarded to N6 (5G) or SGi (4G) interface
- URR tracks packet and byte counts for charging

## 3. Downlink Packet Processing (Data Network → UE)

- **5G**: Packets arrive on N6 interface as native IP
- **4G**: Packets arrive on SGi interface as native IP
- User plane matches packets against downlink PDRs based on UE IP address
- SDF filters may further classify traffic by port, protocol, or application
- FAR determines GTP-U tunnel and forwarding parameters
- GTP-U encapsulation added with appropriate TEID
- **5G**: Packets forwarded to N3 interface toward gNB
- **4G**: Packets forwarded to S1-U (SGW-U) or S5/S8 (PGW-U) toward eNodeB

## 4. Mobility and Handover

- **5G**: OmniSMF updates PDR/FAR rules during handover scenarios
- **4G**: OmniSGW-C/OmniPGW-C updates rules during inter-eNodeB handover or TAU (Tracking Area Update)
- User plane may buffer packets during path switch
- Seamless transition between base stations without packet loss

# Integration with Control Plane (4G and 5G)

OmniUPF integrates with both 5G and 4G control plane functions via standard 3GPP interfaces:

## 5G Interfaces

Interface	From → To	Purpose	3GPP Spec
<b>N4</b>	OmniSMF ↔ OmniUPF	PFCP session establishment, modification, deletion	TS 29.244
<b>N3</b>	gNB → OmniUPF	User plane traffic from RAN (GTP-U)	TS 29.281
<b>N6</b>	OmniUPF → Data Network	User plane traffic to DN (native IP)	TS 23.501
<b>N9</b>	OmniUPF ↔ OmniUPF	Inter-UPF communication for roaming/edge	TS 23.501

## 4G/EPC Interfaces

Interface	From → To	Purpose	3GPP Spec
<b>Sxb</b>	OmniSGW-C ↔ OmniUPF (SGW-U mode)	PFCP session control for serving gateway	TS 29.244
<b>Sxc</b>	OmniPGW-C ↔ OmniUPF (PGW-U mode)	PFCP session control for PDN gateway	TS 29.244
<b>S1-U</b>	eNodeB → OmniUPF (SGW-U mode)	User plane traffic from RAN (GTP-U)	TS 29.281
<b>S5/S8</b>	OmniUPF (SGW-U) ↔ OmniUPF (PGW-U)	Inter-gateway user plane (GTP-U)	TS 29.281
<b>SGi</b>	OmniUPF (PGW-U mode) → PDN	User plane traffic to data network (native IP)	TS 23.401

**Note:** All PFCP interfaces (N4, Sxb, Sxc) use the same PFCP protocol defined in TS 29.244. The interface names differ but the protocol and message formats are identical.

# UPF Components

## eBPF Datapath

The **eBPF datapath** is the core packet processing engine that runs in the Linux kernel for maximum performance.

### Core Functions:

- **GTP-U Processing:** Encapsulation and decapsulation of GTP-U tunnels
- **Packet Classification:** Matching packets against PDR rules using TEID, UE IP, or SDF filters

- **QoS Enforcement:** Apply rate limiting and packet marking per QER rules
- **Forwarding Decisions:** Execute FAR actions (forward, drop, buffer, duplicate, notify)
- **Usage Tracking:** Increment URR counters for volume-based charging

**eBPF Maps:** The datapath uses eBPF maps (hash tables in kernel memory) for rule storage:

Map Name	Purpose	Key	Value
<code>uplink_pdr_map</code>	Uplink PDRs	TEID (32-bit)	PDR info (FAR ID, QER ID, URR IDs)
<code>downlink_pdr_map</code>	Downlink PDRs (IPv4)	UE IP address	PDR info
<code>downlink_pdr_map_ip6</code>	Downlink PDRs (IPv6)	UE IPv6 address	PDR info
<code>far_map</code>	Forwarding rules	FAR ID	Forwarding parameters (action, tunnel info)
<code>qer_map</code>	QoS rules	QER ID	QoS parameters (MBR, GBR, marking)
<code>urr_map</code>	Usage tracking	URR ID	Volume counters (uplink, downlink, total)
<code>sdf_filter_map</code>	SDF filters	PDR ID	Application filters (ports, protocols)

### Performance Characteristics:

- **Zero-copy:** Packets processed entirely in kernel space

- **XDP support:** Attach at network driver level for sub-microsecond latency
- **Multi-core:** Scales across CPU cores with per-CPU map support
- **Capacity:** Millions of PDRs/FARs in eBPF maps (limited by kernel memory)

For capacity monitoring, see [Capacity Management](#).

---

## PFCP Interface Handler

The **PFCP interface** implements 3GPP TS 29.244 for communication with SMF or PGW-C.

### Core Functions:

- **Association Management:** PFCP heartbeat and association setup/release
- **Session Lifecycle:** Create, modify, and delete PFCP sessions
- **Rule Installation:** Translate PFCP IEs into eBPF map entries
- **Event Reporting:** Notify SMF of usage thresholds, errors, or session events

### PFCP Message Support:

Message Type	Direction	Purpose
<b>Association Setup</b>	SMF → UPF	Establish PFCP control association
<b>Association Release</b>	SMF → UPF	Tear down PFCP association
<b>Heartbeat</b>	Bidirectional	Keep association alive
<b>Session Establishment</b>	SMF → UPF	Create new PDU session with PDR/FAR/QER/URR
<b>Session Modification</b>	SMF → UPF	Update rules for mobility, QoS changes
<b>Session Deletion</b>	SMF → UPF	Remove session and all associated rules
<b>Session Report</b>	UPF → SMF	Report usage, errors, or events

### Information Elements (IE) Supported:

- Create PDR, FAR, QER, URR
- Update PDR, FAR, QER, URR
- Remove PDR, FAR, QER, URR
- Packet Detection Information (UE IP, F-TEID, SDF filter)
- Forwarding Parameters (network instance, outer header creation)
- QoS Parameters (MBR, GBR, QFI)
- Usage Report Triggers (volume threshold, time threshold)

---

## REST API Server

The **REST API** provides programmatic access to UPF state and operations.

### Core Functions:

- **Session Monitoring:** Query active PFCP sessions and associations
- **Rule Inspection:** View PDR, FAR, QER, URR configurations
- **Statistics:** Retrieve packet counters, route stats, XDP stats
- **Buffer Management:** View and control packet buffers
- **Map Information:** Monitor eBPF map usage and capacity

**API Endpoints:** (34 total endpoints)

Category	Endpoints	Description
<b>Health</b>	<code>/health</code>	Health check and status
<b>Config</b>	<code>/config</code>	UPF configuration
<b>Sessions</b>	<code>/pfcpsessions</code> , <code>/pfcpsessions</code>	PFCP session/association data
<b>PDRs</b>	<code>/uplink_pdr_map</code> , <code>/downlink_pdr_map</code> , <code>/downlink_pdr_map_ip6</code> , <code>/uplink_pdr_map_ip6</code>	Packet detection rules
<b>FARs</b>	<code>/far_map</code>	Forwarding action rules
<b>QERs</b>	<code>/qer_map</code>	QoS enforcement rules
<b>URRs</b>	<code>/urr_map</code>	Usage reporting rules
<b>Buffers</b>	<code>/buffer</code>	Packet buffer status and control
<b>Statistics</b>	<code>/packet_stats</code> , <code>/route_stats</code> , <code>/xdp_stats</code> , <code>/n3n6_stats</code>	Performance metrics
<b>Capacity</b>	<code>/map_info</code>	eBPF map capacity and usage
<b>Dataplane</b>	<code>/dataplane_config</code>	N3/N9 interface addresses

For API details and usage, see [Monitoring Guide](#).

---

## Web Control Panel

The **Web Control Panel** provides a real-time dashboard for UPF monitoring and management.

### Features:

- **Sessions View:** Browse active PFCP sessions with UE IP, TEID, and rule counts
- **Rules Management:** View and manage PDRs, FARs, QERs, and URRs across all sessions
- **Buffer Monitoring:** Track buffered packets and control buffering per FAR
- **Statistics Dashboard:** Real-time packet, route, XDP, and N3/N6 interface statistics
- **Capacity Monitoring:** eBPF map usage with color-coded capacity indicators
- **Configuration View:** Display UPF configuration and dataplane addresses
- **Logs Viewer:** Live log streaming for troubleshooting

For detailed UI operations, see [Web UI Operations Guide](#).

## PFCP Protocol and SMF Integration

### PFCP Association

Before sessions can be created, the SMF must establish a PFCP association with the UPF.

### Association Lifecycle:

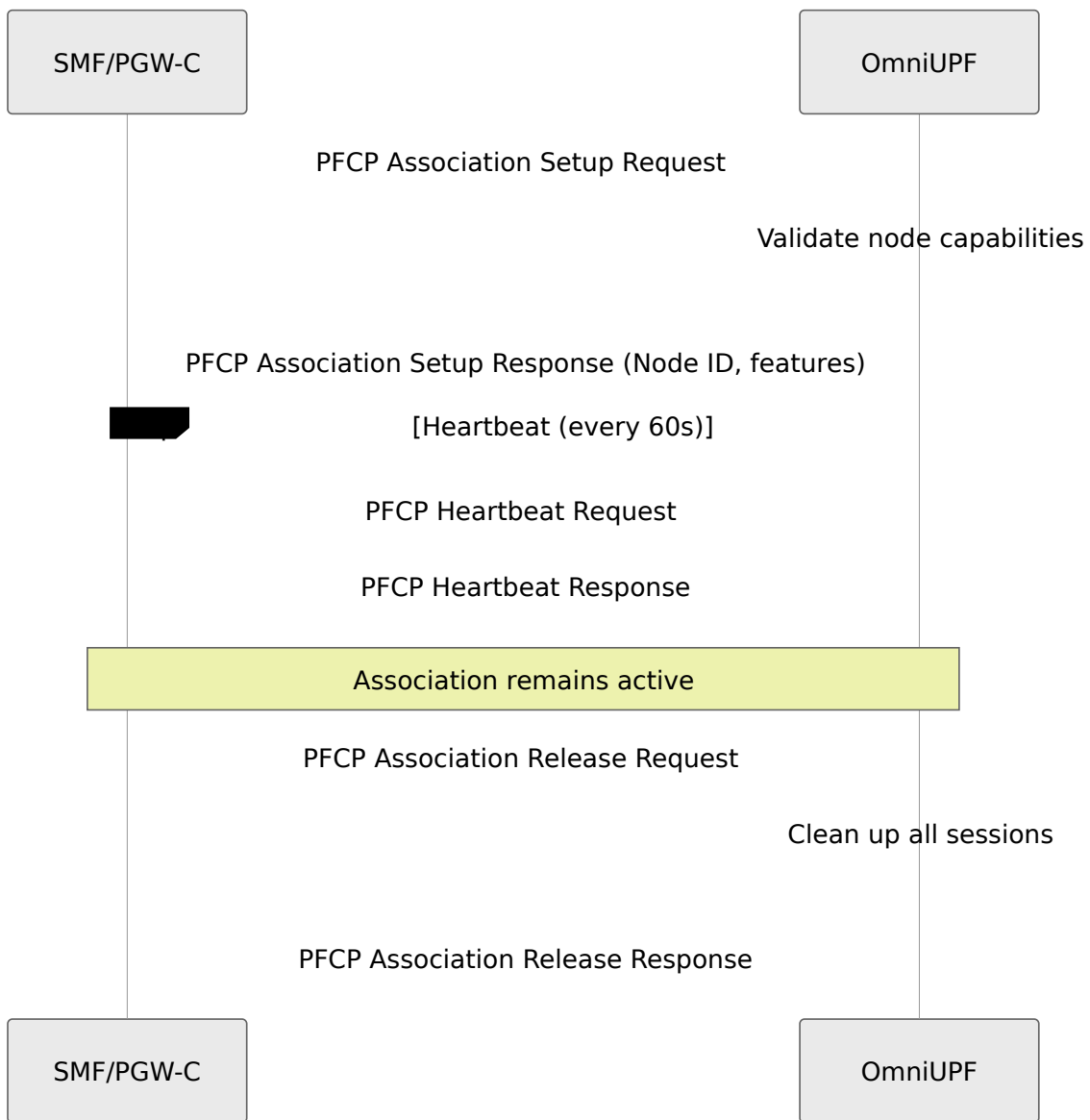

### Key Points:

- Each SMF establishes one association with the UPF
- UPF tracks association by Node ID (FQDN or IP address)
- Heartbeat messages maintain association liveness
- All sessions under an association are deleted if association is released

For viewing associations, see [Sessions View](#).

---

# SMF Restart Detection and Orphaned Session Cleanup

OmniUPF automatically detects when an SMF restarts and cleans up orphaned sessions per 3GPP TS 29.244 specifications.

## How It Works:

When an SMF establishes a PFCP association, it provides a **Recovery Timestamp** indicating when it started. OmniUPF stores this timestamp for each association. If the SMF restarts:

1. SMF loses all session state in memory
2. SMF re-establishes PFCP association with UPF
3. SMF sends **new Recovery Timestamp** (different from before)
4. UPF detects the timestamp change = SMF restarted
5. UPF automatically deletes **all orphaned sessions** from the old SMF instance
6. SMF creates fresh sessions for active subscribers

## Restart Detection Flow:

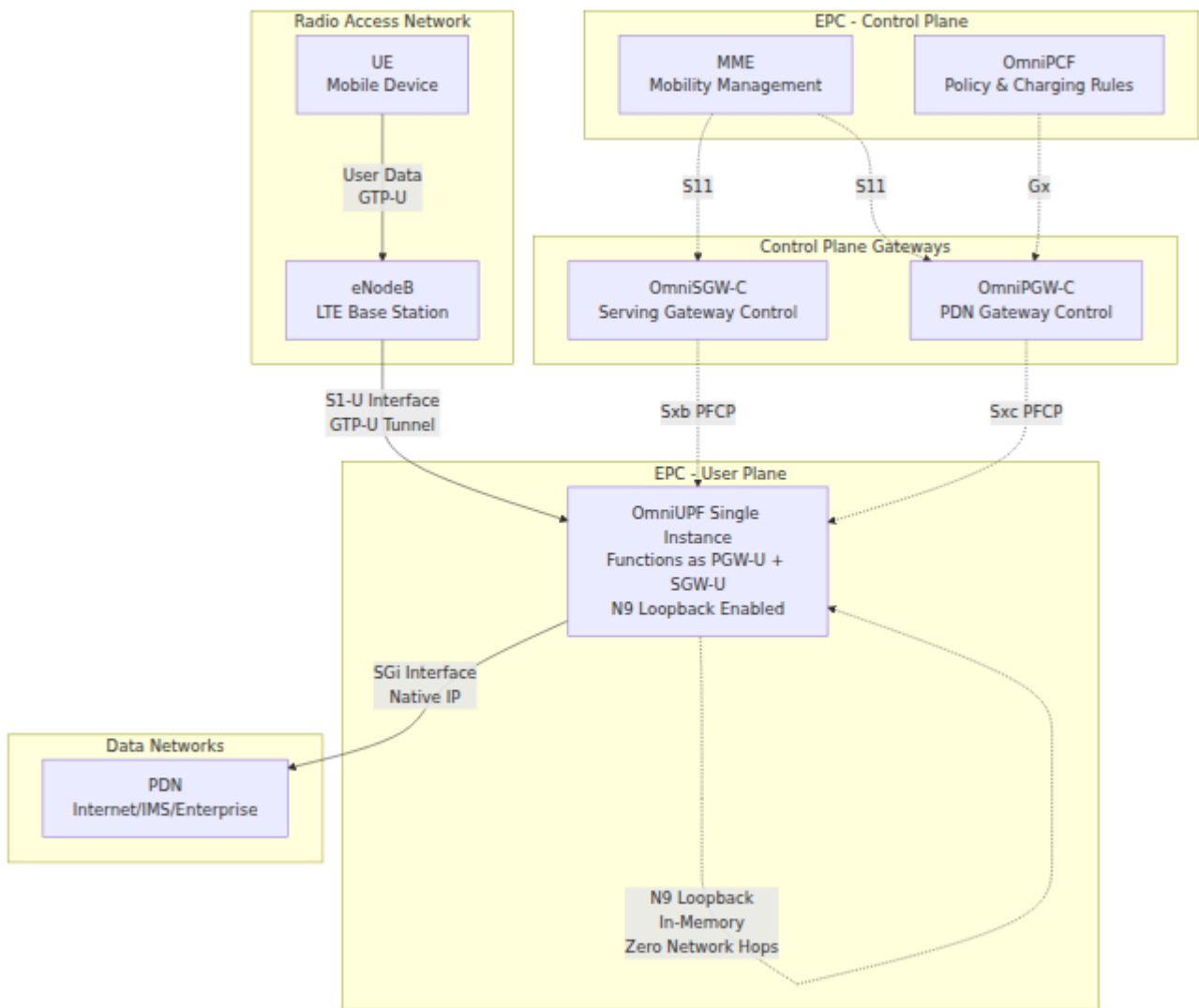

## Log Example:

When an SMF restarts, you'll see:

```

WARN: Association with NodeID: smf-1 and address: 192.168.1.10
already exists
WARN: SMF Recovery Timestamp changed (old: 2025-01-15T10:00:00Z,
new: 2025-01-15T10:30:15Z) - SMF restarted, deleting 245 orphaned
sessions
INFO: Deleting orphaned session 2 (LocalSEID) due to SMF restart
INFO: Deleting orphaned session 3 (LocalSEID) due to SMF restart
...
INFO: Deleting orphaned session 246 (LocalSEID) due to SMF restart

```

## Important Notes:

1. **Isolation:** Only the restarted SMF's sessions are deleted. Other SMF associations and their sessions are **not affected**.
2. **Timestamp Comparison:** If the Recovery Timestamp is **identical**, sessions are **retained** (SMF reconnected without restarting).
3. **3GPP Compliance:** This behavior is mandated by 3GPP TS 29.244 Section 5.22.2:

"If the Recovery Time Stamp of the CP function has changed since the last Association Setup, the UP function shall consider that the CP function has restarted and shall delete all the PFCP sessions associated with that CP function."

For troubleshooting orphaned sessions, see [Orphaned Session Detection](#).

---

## GTP-U Error Indication Handling

OmniUPF handles GTP-U Error Indication messages from downstream peers (PGW-U, SGW-U, eNodeB, gNodeB) per 3GPP TS 29.281 specifications.

### What Are Error Indications:

When OmniUPF forwards a GTP-U packet to a remote peer (e.g., PGW-U in SGW-U deployment), the peer may send back an **Error Indication** if it doesn't recognize the TEID (Tunnel Endpoint Identifier). This indicates:

- The remote peer has restarted and lost tunnel state
- The tunnel was never created on the remote side (configuration mismatch)
- The tunnel was already deleted on the remote side

### How It Works:

1. **UPF forwards packet** → Sends GTP-U packet with TEID X to remote peer (port 2152)
2. **Remote peer doesn't recognize TEID X** → Looks up TEID in its tunnel table, not found

3. **Remote peer sends Error Indication** → GTP-U message type 26 with IE containing erroneous TEID
4. **UPF receives Error Indication** → Parses message to extract TEID X
5. **UPF finds affected sessions** → Searches all sessions for FARs forwarding to TEID X
6. **UPF deletes sessions** → Removes sessions from eBPF maps and PFCP state
7. **UPF updates metrics** → Increments Prometheus counters for monitoring

#### **Error Indication Flow:**

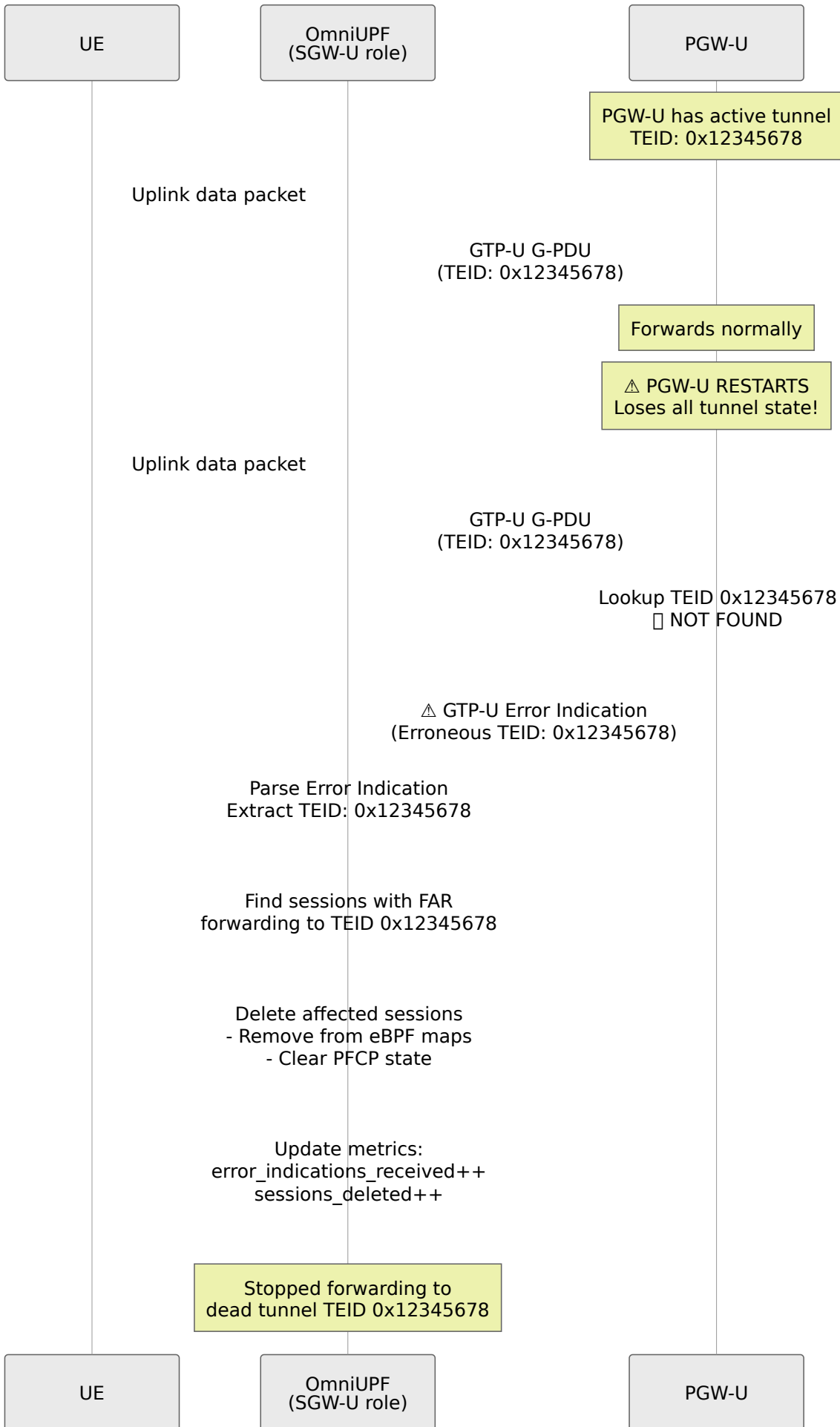

## Packet Format (3GPP TS 29.281 Section 7.3.1):

GTP-U Error Indication:

GTP-U Header (12 bytes)	
Version, PT, Flags	0x32
Message Type	26 (0x1A)
Length	9 bytes
TEID	0 (always)
Sequence Number	varies
N-PDU Number	0
Next Extension Header	0
IE: TEID Data I (5 bytes)	
Type	16 (0x10)
Erroneous TEID	4 bytes

### When This Matters:

#### Scenario 1: PGW-U Restart in S5/S8 GTP Architecture

- SGW-U (OmniUPF) forwards S5/S8 traffic to PGW-U
- PGW-U restarts and loses all S5/S8 tunnel state
- SGW-U continues forwarding to old TEIDs
- PGW-U sends Error Indications
- SGW-U **automatically stops using dead tunnels**

#### Scenario 2: Peer UPF Restart in N9 Architecture

- UPF-1 (OmniUPF) forwards N9 traffic to UPF-2
- UPF-2 restarts
- UPF-1 receives Error Indications
- UPF-1 cleans up sessions

### Log Example:

When receiving an Error Indication:

```
WARN: Received GTP-U Error Indication from 192.168.50.10:2152 for
TEID 0x12345678 - remote peer doesn't recognize this TEID
WARN: Found session LocalSEID=42 with FAR GlobalId=1 forwarding to
erroneous TEID 0x12345678 from peer 192.168.50.10
INFO: Deleting session LocalSEID=42 due to GTP-U Error Indication
for TEID 0x12345678 from 192.168.50.10
WARN: Deleted 1 session(s) due to GTP-U Error Indication for TEID
0x12345678 from peer 192.168.50.10
```

### Prometheus Metrics:

Monitor Error Indication activity with per-peer and per-node granularity:

```
Total Error Indications received from peers
upf_buffer_listener_error_indications_received_total{node_id="pgw-u-
1",peer_address="192.168.50.10"}

Sessions deleted due to Error Indications
upf_buffer_listener_error_indication_sessions_deleted_total{node_id='
u-1",peer_address="192.168.50.10"}

Error Indications sent (for unknown incoming TEIDs)
upf_buffer_listener_error_indications_sent_total{node_id="enodeb-
1",peer_address="10.60.0.1"}
```

### Metric Labels:

- `node_id`: PCF Node ID from the association (or "unknown" if no association exists)
- `peer_address`: IP address of the remote peer

These metrics help identify problematic peers and track Error Indication patterns per control plane node.

### Important Notes:

1. **Automatic Cleanup:** No operator intervention needed - sessions are deleted automatically

2. **TEID Matching:** Only sessions with FARs forwarding to the exact erroneous TEID are deleted
3. **Per-Peer Isolation:** Error Indications from one peer only affect sessions forwarding to that peer
4. **Multiple Sessions:** If multiple sessions forward to the same dead TEID, **all are deleted**
5. **Complementary to Recovery Timestamp:**
  - Recovery Timestamp detection = proactive (detects restart during association setup)
  - Error Indication handling = reactive (detects dead tunnels when traffic flows)
6. **Malformed Packet Handling:** Invalid Error Indications are logged and ignored (no sessions deleted)

For troubleshooting Error Indications, see [GTP-U Error Indication Debugging](#).

---

## PFCP Session Creation

When a UE establishes a PDU session (5G) or PDP context (LTE), the SMF creates a PFCP session at the UPF.

### Session Establishment Flow:

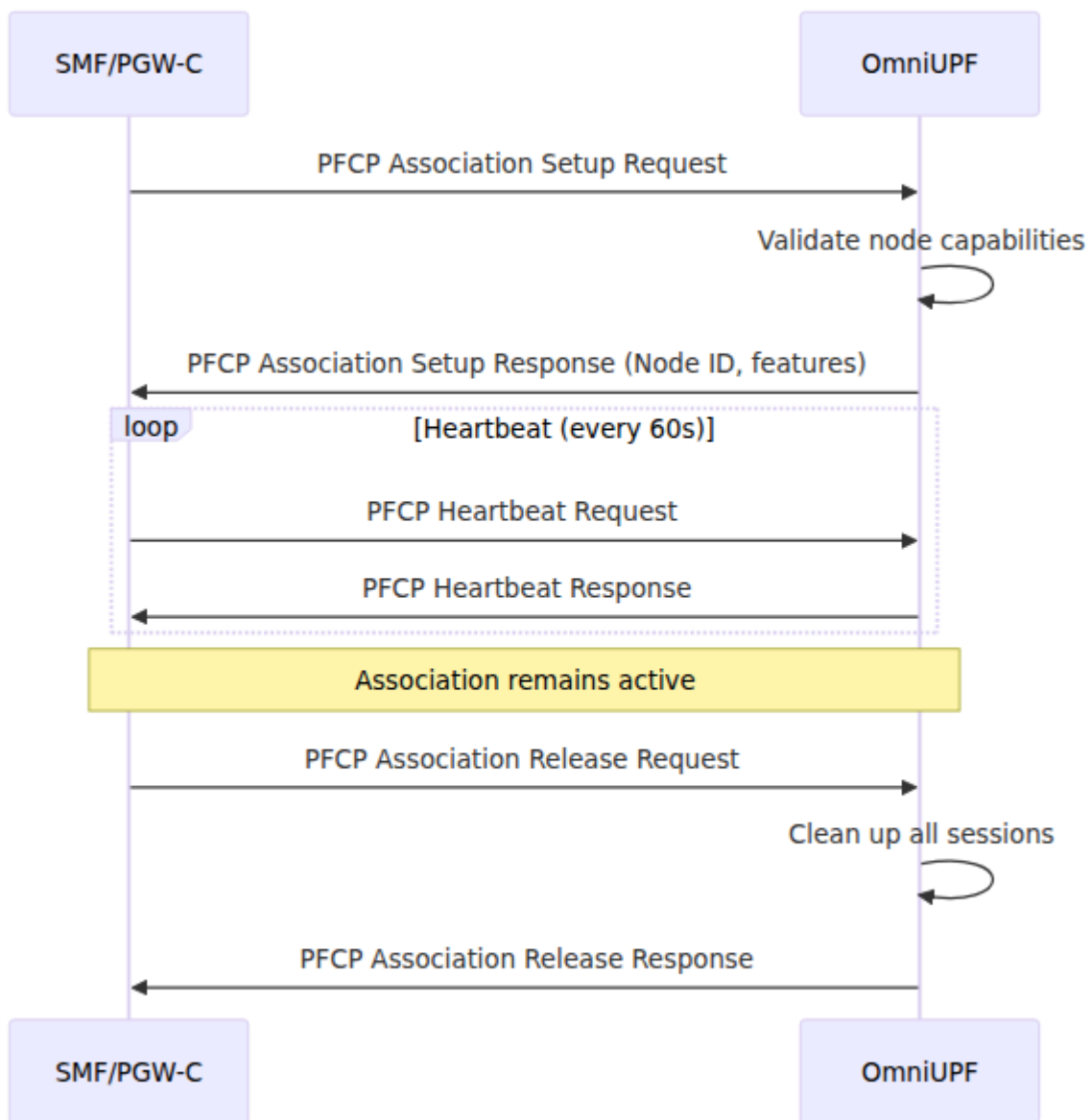

### Typical Session Contents:

- **Uplink PDR:** Match on N3 TEID, forward via FAR to N6
  - **Downlink PDR:** Match on UE IP address, forward via FAR to N3 with GTP-U encapsulation
  - **FAR:** Forwarding parameters (outer header creation, network instance)
  - **QER:** QoS limits (MBR, GBR) and packet marking (QFI)
  - **URR:** Volume reporting for charging (optional)
-

# PFCP Session Modification

SMF can modify sessions for mobility events (handover), QoS changes, or service updates.

## Common Modification Scenarios:

### 1. Handover (N2-based)

- Update uplink FAR with new gNB tunnel endpoint (F-TEID)
- Optionally buffer packets during path switch
- Flush buffer to new path when ready

### 2. QoS Change

- Update QER with new MBR/GBR values
- May add/remove SDF filters in PDR for application-specific QoS

### 3. Service Update

- Add new PDRs for additional traffic flows
- Modify FARs for routing changes

## Session Modification Flow:

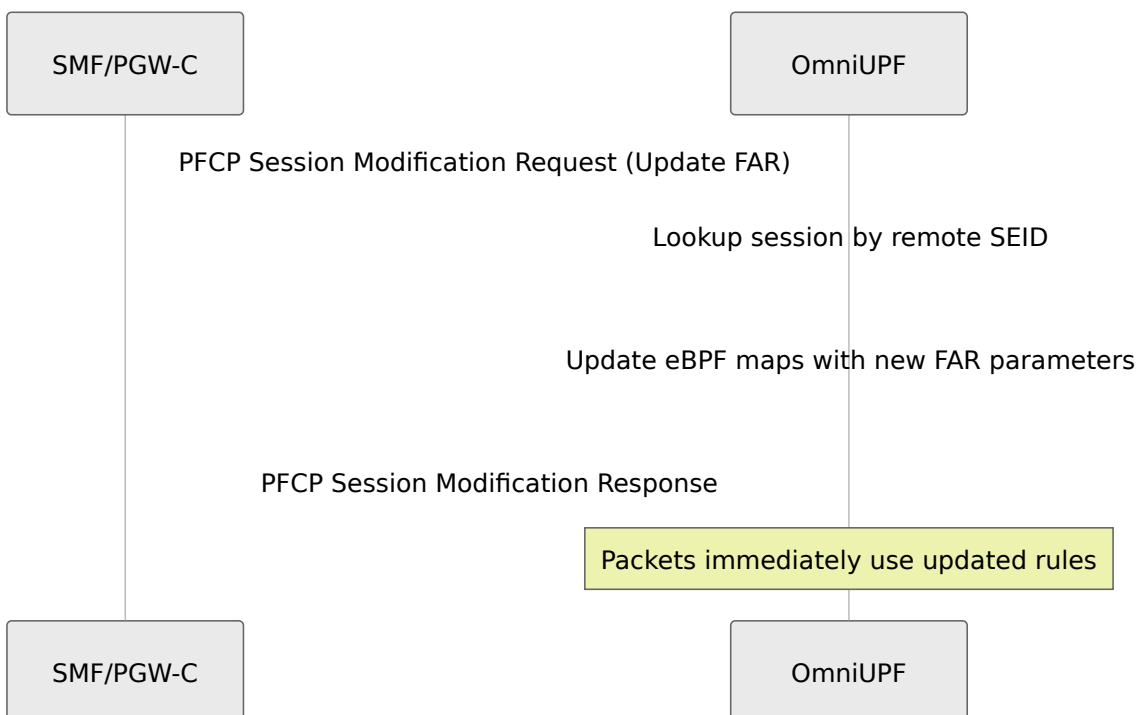

For rule management, see [Rules Management Guide](#).

---

## PFCP Session Deletion

When a PDU session is released, SMF deletes the PFCP session at UPF.

### Session Deletion Flow:

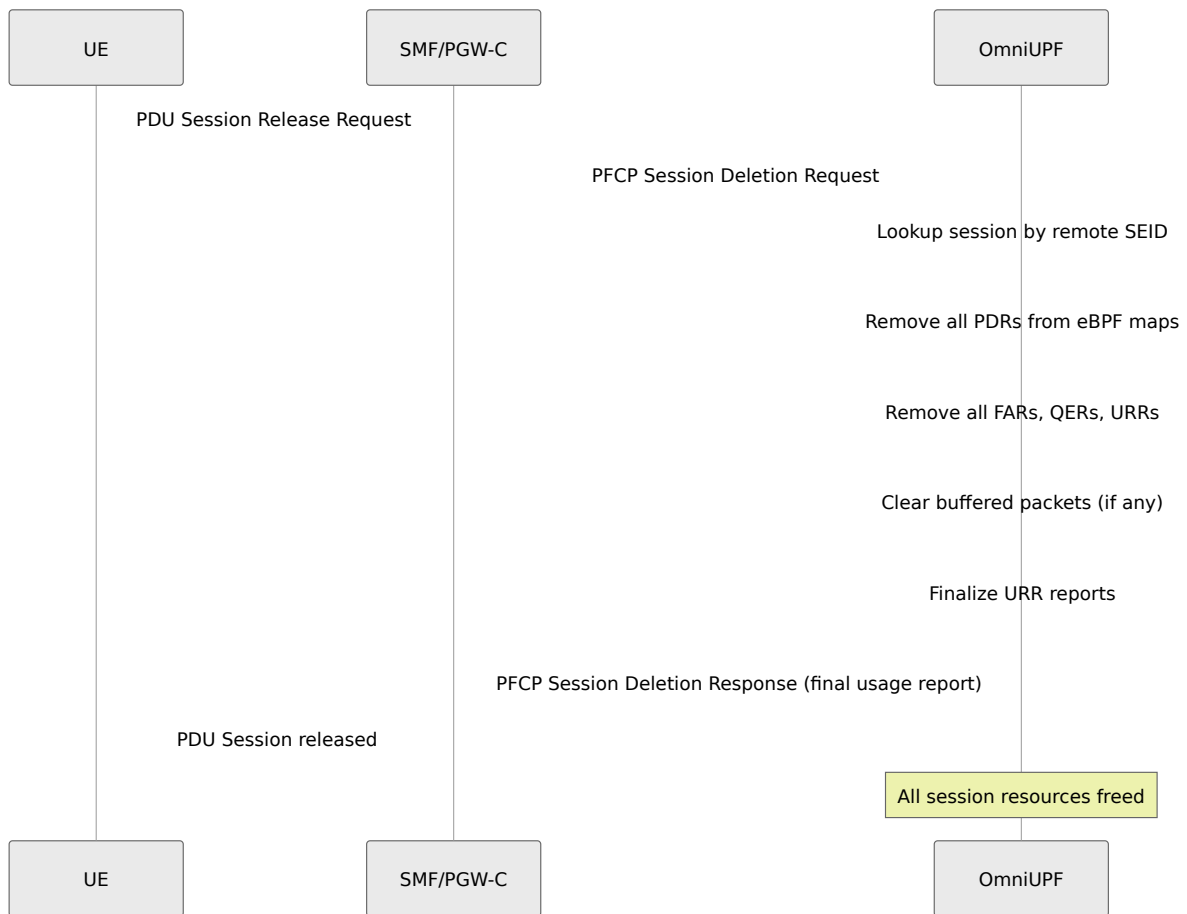

### Cleanup Performed:

- All PDRs removed (uplink and downlink)
- All FARs, QERs, URRs removed
- Packet buffers cleared
- Final usage report sent to SMF for charging

# Common Operations

OmniUPF provides comprehensive operational capabilities through its web-based control panel and REST API. This section covers common operational tasks and their significance.

## Session Monitoring

### Understanding PFCP Sessions:

PFCP sessions represent active UE PDU sessions (5G) or PDP contexts (LTE). Each session contains:

- Local and remote SEIDs (Session Endpoint Identifiers)
- PDRs for packet classification
- FARs for forwarding decisions
- QERs for QoS enforcement (optional)
- URRs for usage tracking (optional)

### Key Session Operations:

- **View all sessions** with UE IP addresses, TEIDs, and rule counts
- **Filter sessions** by IP address or TEID
- **Inspect session details** including full PDR/FAR/QER/URR configurations
- **Monitor session counts** per PFCP association

For detailed session procedures, see [Sessions View](#).

---

## Rule Management

### Packet Detection Rules (PDR):

PDRs determine which packets match specific traffic flows. Operators can:

- **View uplink PDRs** keyed by TEID from N3 interface
- **View downlink PDRs** keyed by UE IP address (IPv4 and IPv6)

- **Inspect SDF filters** for application-specific classification
- **Monitor PDR counts** and capacity usage

### **Forwarding Action Rules (FAR):**

FARs define what to do with matched packets. Operators can:

- **View FAR actions** (FORWARD, DROP, BUFFER, DUPLICATE, NOTIFY)
- **Inspect forwarding parameters** (outer header creation, destination)
- **Monitor buffering status** per FAR
- **Toggle buffering** for specific FARs during troubleshooting

### **QoS Enforcement Rules (QER):**

QERs apply bandwidth limits and packet marking. Operators can:

- **View QoS parameters** (MBR, GBR, packet delay budget)
- **Monitor active QERs** per session
- **Inspect QFI markings** for 5G QoS flows

### **Usage Reporting Rules (URR):**

URRs track data volumes for charging. Operators can:

- **View volume counters** (uplink, downlink, total bytes)
- **Monitor usage thresholds** and reporting triggers
- **Inspect active URRs** across all sessions

For rule operations, see [Rules Management Guide](#).

---

## **Packet Buffering**

### **Why Buffering is Critical for UPF**

**Packet buffering is one of the most important functions of a UPF**

because it prevents packet loss during mobility events and session reconfigurations. Without buffering, mobile users would experience dropped

connections, interrupted downloads, and failed real-time communications every time they move between cell towers or when network conditions change.

### **The Problem: Packet Loss During Mobility**

In mobile networks, users are constantly moving. When a device moves from one cell tower to another (handover), or when the network needs to reconfigure the data path, there's a critical window where packets are in flight but the new path isn't ready yet:

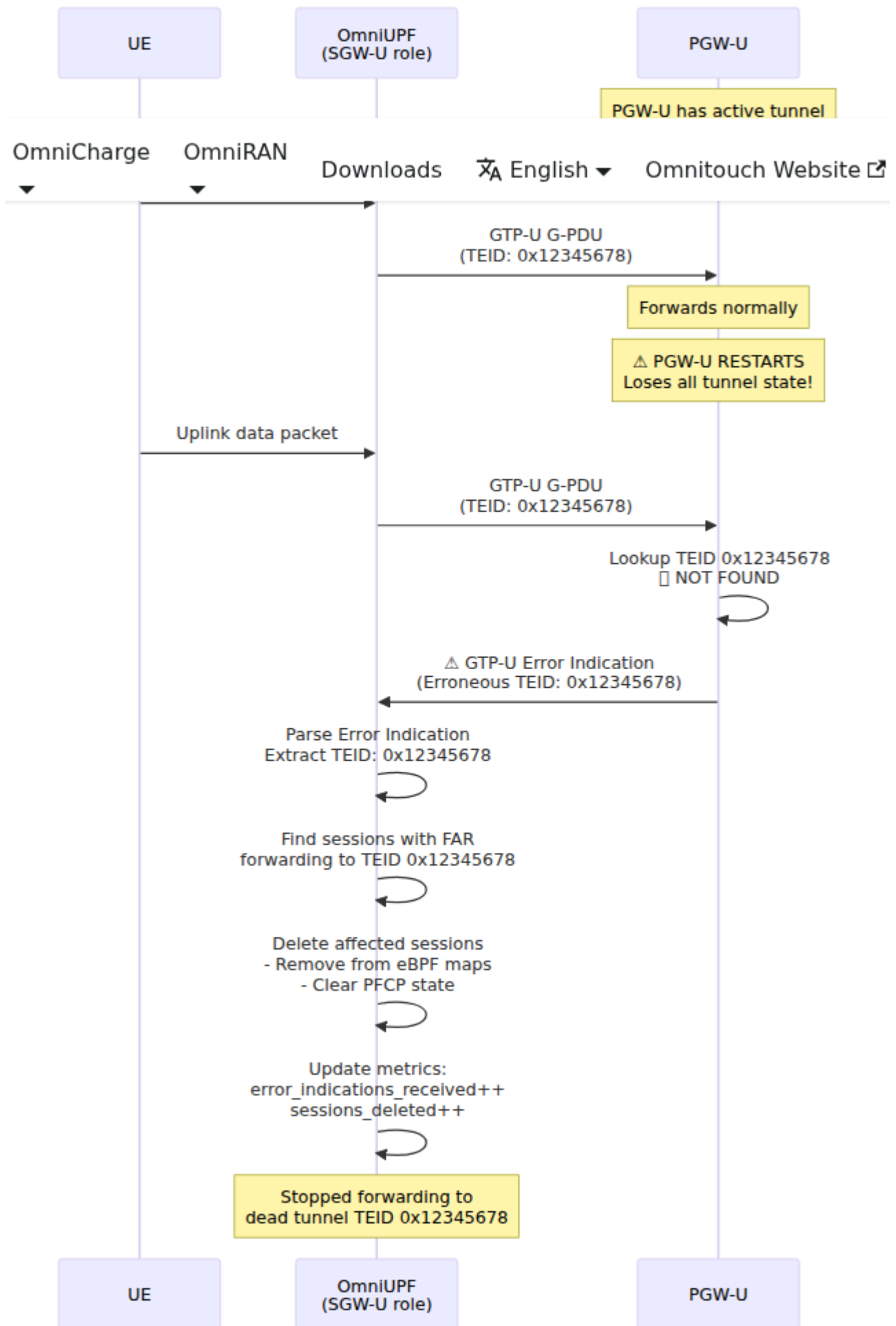

**Without buffering:** Packets arriving during this critical window would be **dropped**, causing:

- **TCP connections to stall** or reset (web browsing, downloads interrupted)
- **Video calls to freeze** or drop (Zoom, Teams, WhatsApp calls fail)
- **Gaming sessions to disconnect** (online gaming, real-time apps fail)
- **VoIP calls to have gaps** or drop entirely (phone calls interrupted)
- **Downloads to fail** and need to restart

**With buffering:** OmniUPF temporarily holds packets until the new path is established, then forwards them seamlessly. The user experiences **zero interruption**.

---

## When Buffering Happens

OmniUPF buffers packets in these critical scenarios:

### 1. N2-Based Handover (5G) / X2-Based Handover (4G)

When a UE moves between cell towers:

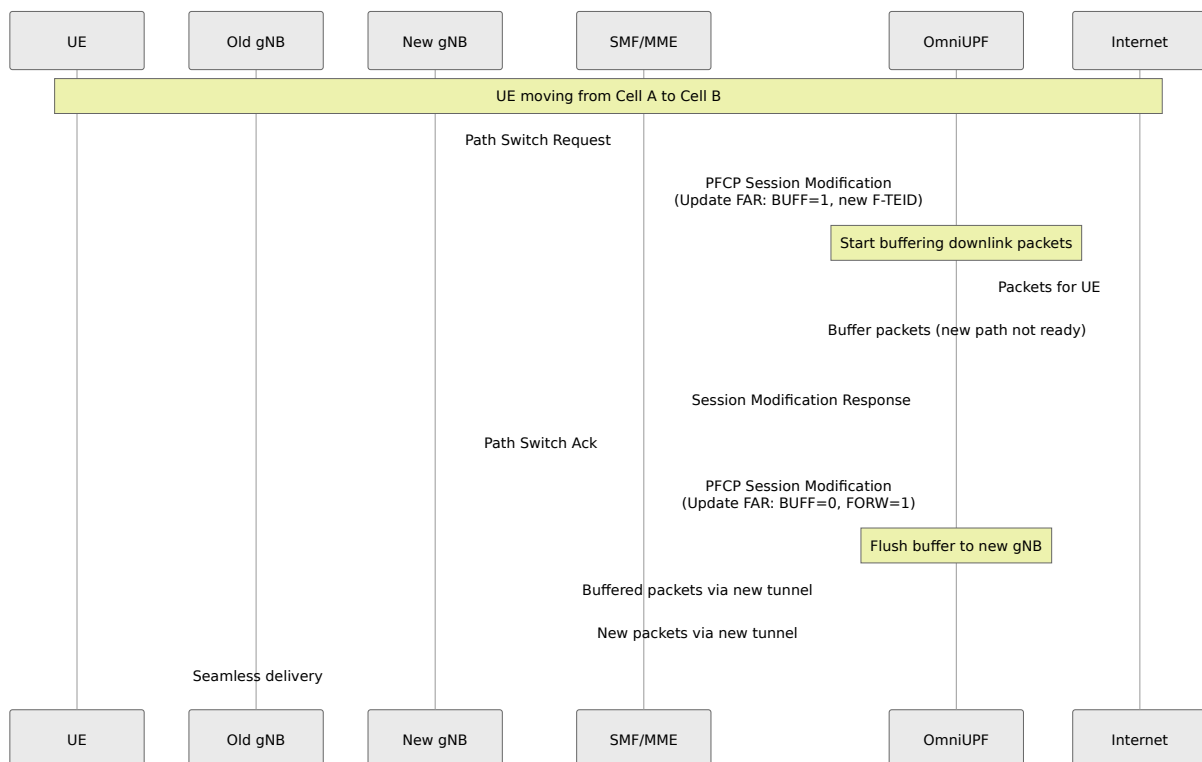

**Timeline:**

- **T+0ms**: Old path still active
- **T+10ms**: SMF tells UPF to buffer (old path closing, new path not ready)
- **T+10-50ms**: **Critical buffering window** - packets arrive but can't be forwarded
- **T+50ms**: New path ready, SMF tells UPF to forward
- **T+50ms+**: UPF flushes buffered packets to new path, then forwards new packets normally

**Without buffering**: ~40ms of packets (potentially thousands) would be **lost**.

**With buffering**: Zero packet loss, seamless handover.

---

## 2. Session Modification (QoS Change, Path Update)

When the network needs to change session parameters:

- **QoS upgrade/downgrade**: User moves from 4G to 5G coverage (NSA mode)
- **Policy change**: Enterprise user enters corporate campus (traffic steering changes)
- **Network optimization**: Core network reroutes traffic to closer UPF (ULCL update)

During the modification, the control plane may need to update multiple rules atomically. Buffering ensures packets aren't forwarded with partial/inconsistent rule sets.

---

## 3. Downlink Data Notification (Idle Mode Recovery)

When a UE is in idle mode (screen off, battery saving) and downlink data arrives:

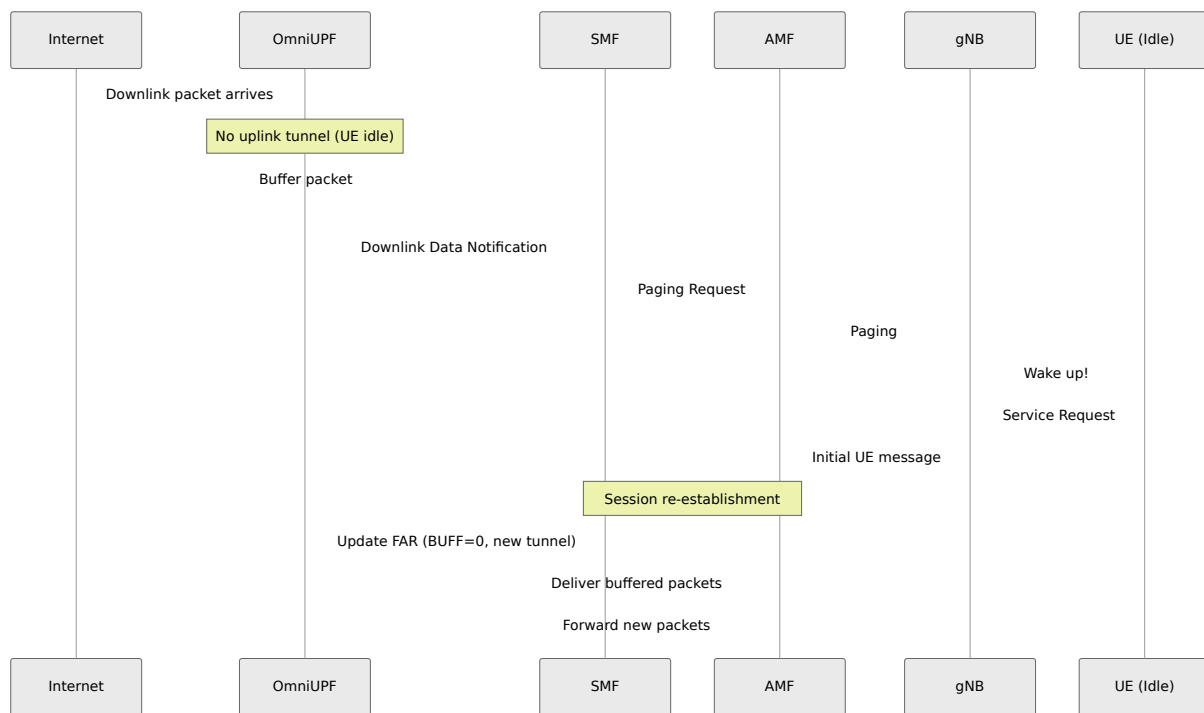

**Without buffering:** The initial packet that triggered the notification would be **lost**, requiring the sender to retransmit (adds latency). **With buffering:** The packet that woke up the UE is delivered immediately when the UE reconnects.

#### 4. Inter-RAT Handover (4G ↔ 5G)

When a UE moves between 4G and 5G coverage:

- Architecture changes (eNodeB ↔ gNB)
- Tunnel endpoints change (different TEID allocation)
- Buffering ensures smooth transition between RAT types

#### How Buffering Works in OmniUPF

##### Technical Mechanism:

OmniUPF uses a **two-stage buffering architecture**:

1. **eBPF Stage (Kernel):** Detects packets requiring buffering based on FAR action flags
2. **Userspace Stage:** Stores and manages buffered packets in memory

##### Buffering Process:

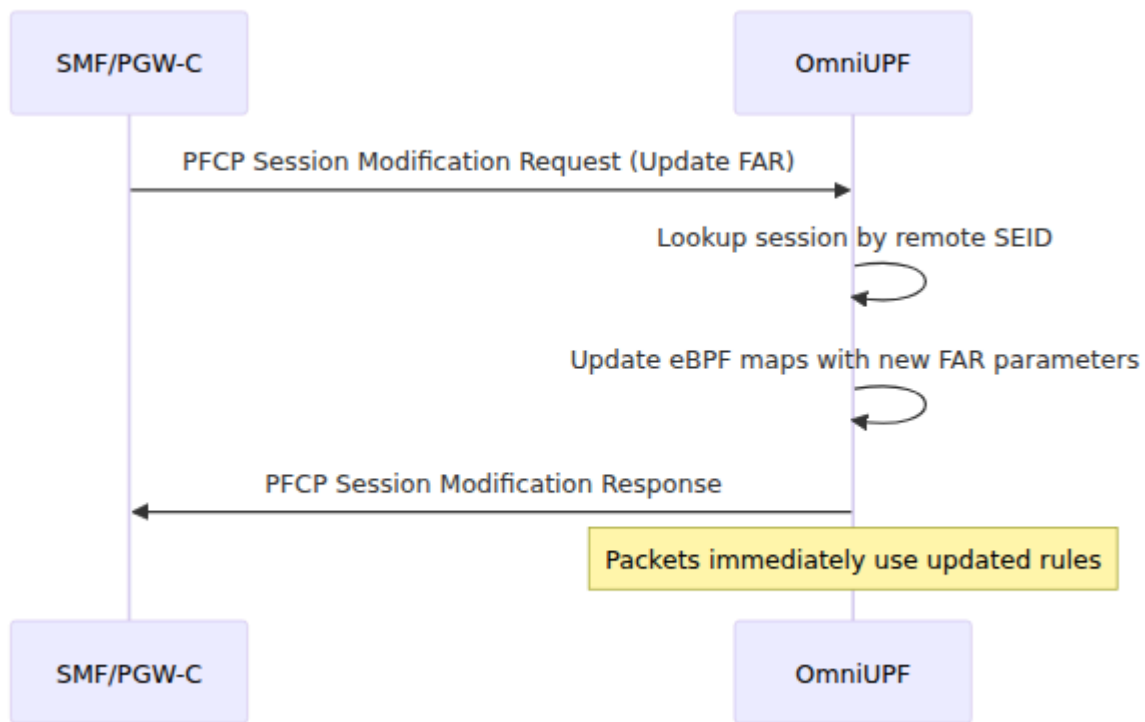

### Key Details:

- **Buffer Port:** UDP port 22152 (packets sent from eBPF to userspace)
- **Encapsulation:** Packets wrapped in GTP-U with FAR ID as TEID
- **Storage:** In-memory per-FAR buffers with metadata (timestamp, direction, packet size)
- **Limits:**
  - Per-FAR limit: 10,000 packets (default)
  - Global limit: 100,000 packets across all FARs
  - TTL: 30 seconds (default) - packets older than TTL are discarded
- **Cleanup:** Background process removes expired packets every 60 seconds

### Buffer Lifecycle:

1. **Buffering Enabled:** SMF sets FAR action BUFF=1 (bit 2) via PFCP Session Modification
2. **Packets Buffered:** eBPF detects BUFF flag, encapsulates packets, sends to port 22152
3. **Userspace Storage:** Buffer manager stores packets with FAR ID, timestamp, direction
4. **Buffering Disabled:** SMF sets FAR action FORW=1, BUFF=0 with new forwarding parameters

5. **Flush Buffer:** Userspace replays buffered packets using new FAR rules (new tunnel endpoint)
6. **Resume Normal:** New packets forwarded immediately via new path

---

## Why This Matters for User Experience

### Real-World Impact:

Scenario	Without Buffering	With Buffering
<b>Video Call During Handover</b>	Call freezes for 1-2 seconds, may drop	Seamless, no interruption
<b>File Download at Cell Edge</b>	Download fails, must restart	Download continues uninterrupted
<b>Online Gaming While Moving</b>	Connection drops, kicked from game	Smooth gameplay, no disconnects
<b>VoIP Call in Car</b>	Call drops every handover	Crystal clear, no drops
<b>Streaming Video on Train</b>	Video buffers, quality drops	Smooth playback
<b>Mobile Hotspot for Laptop</b>	SSH session drops, video call fails	All connections maintained

### Network Operator Benefits:

- **Reduced Call Drop Rate (CDR):** Critical KPI for network quality
- **Higher Customer Satisfaction:** Users don't notice handovers
- **Lower Support Costs:** Fewer complaints about dropped connections
- **Competitive Advantage:** "Best network for coverage" marketing

---

## Buffer Management Operations

Operators can monitor and control buffering via the Web UI and API:

### Monitoring:

- **View buffered packets** per FAR ID (count, bytes, age)
- **Track buffer usage** against limits (per-FAR, global)
- **Alert on buffer overflow** or excessive buffering duration
- **Identify stuck buffers** (packets buffered > TTL threshold)

### Control Operations:

- **Flush buffers:** Manually trigger buffer replay (troubleshooting)
- **Clear buffers:** Discard buffered packets (clean up stuck buffers)
- **Adjust TTL:** Change packet expiration time
- **Modify limits:** Increase per-FAR or global buffer capacity

### Troubleshooting:

- **Buffer not flushing:** Check if SMF sent FAR update to disable buffering
- **Buffer overflow:** Increase limits or investigate why buffering duration is excessive
- **Old packets in buffer:** TTL may be too high, or FAR update delayed
- **Excessive buffering:** May indicate mobility issues or SMF problems

For detailed buffer operations, see [Buffer Management Guide](#).

---

## Buffer Configuration

Configure buffering behavior in `config.yml`:

```
Buffer settings
buffer_port: 22152 # UDP port for buffered packets
 (default)
buffer_max_packets: 10000 # Max packets per FAR (prevent
 memory exhaustion)
buffer_max_total: 100000 # Max total packets across all
 FARs
buffer_packet_ttl: 30 # TTL in seconds (discard old
 packets)
buffer_cleanup_interval: 60 # Cleanup interval in seconds
```

## Recommendations:

- **High-mobility networks** (highways, trains): Increase `buffer_max_packets` to 20,000+
- **Dense urban areas** (frequent handovers): Decrease `buffer_packet_ttl` to 15s
- **Low-latency applications**: Set `buffer_packet_ttl` to 10s to prevent stale data
- **IoT networks**: Decrease limits (IoT devices generate less traffic during handover)

For complete configuration options, see [Configuration Guide](#).

---

## Statistics and Monitoring

### Packet Statistics:

Real-time packet processing metrics including:

- **RX packets**: Total received from all interfaces
- **TX packets**: Total transmitted to all interfaces
- **Dropped packets**: Packets discarded due to errors or policy
- **GTP-U packets**: Tunneled packet counts

### Route Statistics:

Per-route forwarding metrics:

- **Route hits:** Packets matched by each route
- **Forwarding counts:** Success/failure per destination
- **Error counters:** Invalid TEIDs, unknown UE IPs

### **XDP Statistics:**

eXpress Data Path performance metrics:

- **XDP processed:** Packets handled at XDP layer
- **XDP passed:** Packets sent to network stack
- **XDP dropped:** Packets dropped at XDP layer
- **XDP aborted:** Processing errors

### **N3/N6 Interface Statistics:**

Per-interface traffic counters:

- **N3 RX/TX:** Traffic to/from RAN (gNB/eNodeB)
- **N6 RX/TX:** Traffic to/from data network
- **Total packet counts:** Aggregate interface statistics

For monitoring details, see [Monitoring Guide](#).

---

## **Capacity Management**

### **eBPF Map Capacity Monitoring:**

UPF performance depends on eBPF map capacity. Operators can:

- **Monitor map usage** with real-time percentage indicators
- **View capacity limits** for each eBPF map
- **Color-coded alerts:**
  - Green (<50%): Normal
  - Yellow (50-70%): Caution
  - Amber (70-90%): Warning

- Red (>90%): Critical

### Critical Maps to Monitor:

- `uplink_pdr_map`: Uplink traffic classification
- `downlink_pdr_map`: Downlink IPv4 traffic classification
- `far_map`: Forwarding rules
- `qer_map`: QoS rules
- `urr_map`: Usage tracking

### Capacity Planning:

- Each PDR consumes one map entry (key size + value size)
- Map capacity is configured at UPF startup (kernel memory limit)
- Exceeding capacity causes session establishment failures

For capacity monitoring, see [Capacity Management](#).

---

## Configuration Management

### UPF Configuration:

View and verify UPF operational parameters:

- **N3 Interface**: IP address for RAN connectivity (GTP-U)
- **N6 Interface**: IP address for data network connectivity
- **N9 Interface**: IP address for inter-UPF communication (optional)
- **PFCP Interface**: IP address for SMF connectivity
- **API Port**: REST API listening port
- **Metrics Endpoint**: Prometheus metrics port

### Dataplane Configuration:

Active eBPF datapath parameters:

- **Active N3 address**: Runtime N3 interface binding
- **Active N9 address**: Runtime N9 interface binding (if enabled)

For configuration viewing, see [Configuration View](#).

# Troubleshooting

This section covers common operational issues and their resolution strategies.

## Session Establishment Failures

**Symptoms:** PFCP sessions fail to create, UE cannot establish data connectivity

**Common Root Causes:**

### 1. PFCP Association Not Established

- Verify SMF can reach UPF PFCP interface (port 8805)
- Check PFCP association status in Sessions view
- Verify Node ID configuration matches between SMF and UPF

### 2. eBPF Map Capacity Exhausted

- Check Capacity view for red (>90%) map usage
- Increase eBPF map sizes in UPF configuration
- Delete stale sessions if map is full

### 3. Invalid PDR/FAR Configuration

- Verify UE IP address is unique and valid
- Check TEID allocation doesn't conflict
- Ensure FAR references valid network instances

### 4. Interface Configuration Issues

- Verify N3 interface IP is reachable from gNB
- Check routing tables for N6 connectivity to data network
- Confirm GTP-U traffic is not blocked by firewall

For detailed troubleshooting, see [Troubleshooting Guide](#).

---

# Packet Loss or Forwarding Issues

**Symptoms:** UE has connectivity but experiences packet loss or no traffic flow

**Common Root Causes:**

## 1. PDR Misconfiguration

- Verify uplink PDR TEID matches gNB-assigned TEID
- Check downlink PDR UE IP matches assigned IP
- Inspect SDF filters for overly restrictive rules

## 2. FAR Action Issues

- Verify FAR action is FORWARD (not DROP or BUFFER)
- Check outer header creation parameters for GTP-U
- Ensure destination endpoint is correct

## 3. QoS Limits Exceeded

- Check QER MBR (Maximum Bit Rate) settings
- Verify GBR (Guaranteed Bit Rate) allocation
- Monitor packet drops due to rate limiting

## 4. Interface MTU Issues

- Verify GTP-U overhead (40-50 bytes) doesn't cause fragmentation
- Check N3/N6 interface MTU configuration
- Monitor for ICMP fragmentation needed messages

---

## Buffer-Related Issues

**Symptoms:** Packets buffered indefinitely, buffer overflow

**Common Root Causes:**

### 1. Buffering Not Disabled After Handover

- Check FAR buffering flag (bit 2)
- Verify SMF sent Session Modification to disable buffering
- Manually disable buffering via control panel if stuck

## 2. Buffer TTL Expiration

- Check packet age in buffer view
- Verify buffer TTL configuration (default may be too long)
- Clear expired buffers manually

## 3. Buffer Capacity Exhausted

- Monitor total buffer usage and per-FAR limits
- Check for misconfigured rules causing excessive buffering
- Adjust max\_per\_far and max\_total buffer limits

For buffer troubleshooting, see [Buffer Operations](#).

---

# Statistics Anomalies

**Symptoms:** Unexpected packet counters, missing statistics

**Common Root Causes:**

## 1. Counter Overflow

- eBPF maps use 64-bit counters (should not overflow)
- Check for counter reset events in logs
- Verify URR reporting is functioning

## 2. Route Statistics Not Updating

- Verify eBPF program is attached to interfaces
- Check kernel version supports required eBPF features
- Review XDP statistics for processing errors

## 3. Interface Statistics Mismatch

- Compare N3/N6 stats with kernel interface counters
  - Check for traffic bypassing eBPF (e.g., local routing)
  - Verify all traffic flows through XDP hooks
- 

## Performance Degradation

**Symptoms:** High latency, low throughput, CPU saturation

**Diagnosis:**

1. **Monitor XDP Statistics:** Check for XDP drops or aborts
2. **Check eBPF Map Access Time:** Hash lookups should be sub-microsecond
3. **Review CPU Utilization:** eBPF should distribute across cores
4. **Analyze Network Interface:** Verify NIC supports XDP offload

**Scalability Considerations:**

- **XDP Performance:** 10M+ packets per second per core
- **PDR Capacity:** Millions of PDRs limited only by kernel memory
- **Session Count:** Thousands of concurrent sessions per UPF instance
- **Throughput:** Multi-gigabit throughput with proper NIC offload

For performance tuning, see [Architecture Guide](#).

## Additional Documentation

### Component-Specific Operations Guides

For detailed operations and troubleshooting for each UPF component:

#### Configuration Guide

Complete configuration reference including:

- Configuration parameters (YAML, environment variables, CLI)
- Operating modes (UPF/PGW-U/SGW-U)

- XDP attachment modes overview
- Hypervisor compatibility (Proxmox, VMware, KVM, Hyper-V, VirtualBox)
- NIC compatibility and XDP driver support
- Configuration examples for different scenarios
- Map sizing and capacity planning

## **XDP Modes Guide**

Detailed XDP configuration and optimization including:

- XDP attachment modes explained (generic/native/offload)
- Performance comparison and benchmarks
- Step-by-step Proxmox VE native XDP setup
- Multi-queue configuration for optimal performance
- VMware ESXi, KVM, and Hyper-V XDP setup
- XDP verification and troubleshooting
- Hardware selection for XDP performance

## **Architecture Guide**

Deep technical dive including:

- eBPF technology foundation and program lifecycle
- XDP packet processing pipeline with tail calls
- PFCP protocol implementation
- Buffering architecture (GTP-U encapsulation to port 22152)
- QoS sliding window rate limiting (5ms window)
- Performance characteristics (3.5 $\mu$ s latency, 10 Mpps/core)

## **Rules Management Guide**

PFCP rules reference including:

- Packet Detection Rules (PDR) - Traffic classification
- Forwarding Action Rules (FAR) - Routing decisions with action flags
- QoS Enforcement Rules (QER) - Bandwidth management (MBR/GBR)
- Usage Reporting Rules (URR) - Volume tracking and reporting

- Uplink and downlink packet flow diagrams
- Rule processing logic and precedence

## Monitoring Guide

Statistics and capacity management including:

- N3/N6 interface statistics and traffic distribution
- XDP processing statistics (pass/drop/redirect/abort)
- eBPF map capacity monitoring with color-coded zones
- Performance metrics (packet rate, throughput, drop rate)
- Capacity planning formulas and session estimation
- Alerting thresholds and best practices

## Web UI Operations Guide

Control panel usage including:

- Dashboard overview and navigation
- Sessions monitoring (healthy/unhealthy states)
- Rules inspection (PDR, FAR, QER, URR details)
- Buffer monitoring and packet buffering state
- Real-time statistics dashboard
- eBPF map capacity visualization
- Configuration viewing

## API Documentation

Complete REST API reference including:

- OpenAPI/Swagger interactive documentation
- API pagination (page-based and offset-based)
- PFCP sessions and associations endpoints
- Packet Detection Rules (PDR) - IPv4 and IPv6
- Forwarding Action Rules (FAR)
- QoS Enforcement Rules (QER)
- Usage Reporting Rules (URR)

- Packet buffer management
- Statistics and monitoring endpoints
- Route management and FRR integration
- eBPF map information
- Configuration management
- Authentication and security guidelines
- Common API workflows and examples

## Metrics Reference

Prometheus metrics documentation including:

- PFCP message metrics (counters, latency, errors per peer)
- XDP action metrics (dataplane verdicts)
- Packet metrics (protocol-level counters with packet\_type labels)
- PFCP session and association metrics (per control plane node)
- URR metrics (traffic volume per PFCP peer)
- Packet buffering metrics (buffer state, capacity, throughput)
- Downlink Data Report notification metrics (DLDR tracking)
- eBPF map capacity metrics (resource utilization)
- Prometheus configuration examples
- Grafana dashboard recommendations

## PFCP Cause Codes Reference

PFCP error code documentation including:

- Cause code definitions and 3GPP compliance (TS 129.244)
- When each cause code occurs (success, client errors, server errors)
- Common failure scenarios with resolutions
- Troubleshooting with Prometheus metrics
- Association setup and session lifecycle failures
- Debugging steps for high rejection rates
- Alerting recommendations for cause codes

## UE Route Management Guide

FRR routing integration including:

- FRR (Free Range Routing) overview and architecture
- UE route synchronization lifecycle
- Automatic route sync to routing daemon
- Route advertisement via OSPF and BGP
- OSPF neighbor monitoring
- OSPF External LSA database verification
- BGP peer session management
- Web UI route monitoring interface
- Manual route sync operations
- Mermaid diagrams for route flow and architecture

## Troubleshooting Guide

Comprehensive problem diagnosis including:

- Quick diagnostic checklist and tools
- Installation and configuration issues
- PFCP association failures
- Packet processing problems
- XDP and eBPF errors
- Performance degradation
- Hypervisor-specific issues (Proxmox, VMware, VirtualBox)
- NIC and driver problems
- Step-by-step resolution procedures

---

## Documentation by Use Case

### Installing and Configuring OmniUPF

1. Start with this guide for overview
2. [Configuration Guide](#) for setup parameters
3. [Web UI Guide](#) to access control panel

## Deploying SGWU+PGWU on Single Instance (N9 Loopback)

1. [N9 Loopback Operations Guide](#) - Complete guide for combined SGWU+PGWU deployment
2. [N9 Loopback - Configuration](#) - Network and PFCP setup
3. [N9 Loopback - Monitoring](#) - Verify loopback is active
4. [N9 Loopback - Troubleshooting](#) - Common issues and solutions

## Deploying on Proxmox

1. [XDP Modes Guide - Proxmox Native XDP Setup](#) - **Start here for performance**
2. [Configuration Guide - Hypervisor Compatibility](#)
3. [Configuration Guide - Proxmox SR-IOV Setup](#)
4. [Troubleshooting - Proxmox Issues](#)

## Optimizing Performance

1. [XDP Modes Guide](#) - **Enable native XDP for 5-10x performance boost**
2. [Architecture Guide - Performance Optimization](#)
3. [Configuration Guide - XDP Modes](#)
4. [Monitoring Guide - Performance Metrics](#)
5. [Troubleshooting - Performance Issues](#)

## Understanding Packet Processing

1. [Architecture Guide - Packet Processing Pipeline](#)
2. [Rules Management Guide](#)
3. [Monitoring Guide - Statistics](#)

## Planning Capacity

1. [Configuration Guide - Map Sizing](#)
2. [Monitoring Guide - Capacity Planning](#)
3. [Monitoring Guide - Session Capacity Estimation](#)

## Managing UE Routes and FRR Integration

1. [UE Route Management Guide](#) - Complete routing integration guide
2. [API Documentation - Route Management](#) - Route API endpoints
3. [Web UI Guide](#) - Routes page operations
4. [UE Route Management - FRR Verification](#) - OSPF LSA verification

## Using the REST API

1. [API Documentation](#) - Complete API reference
2. [API Documentation - Swagger UI](#) - Interactive API explorer
3. [API Documentation - Common Workflows](#) - API usage examples
4. [Web UI Guide](#) - Web interface as API client example

## Troubleshooting Issues

1. [Troubleshooting Guide](#) - Start here
  2. [Monitoring Guide](#) - Check statistics and capacity
  3. [Web UI Guide](#) - Use control panel diagnostics
- 

# Quick Reference

## Common API Endpoints

OmniUPF provides a REST API for monitoring and management:

```

Status and health
GET http://localhost:8080/api/v1/upf_status

PFCP associations
GET http://localhost:8080/api/v1/upf_pipeline

Sessions
GET http://localhost:8080/api/v1/sessions

Statistics
GET http://localhost:8080/api/v1/packet_stats
GET http://localhost:8080/api/v1/xdp_stats

Capacity monitoring
GET http://localhost:8080/api/v1/map_info

Buffer statistics
GET http://localhost:8080/api/v1/upf_buffer_info

```

For complete API documentation, access the Swagger UI at <http://<upf-ip>:8080/swagger/index.html>

## Essential Configuration Parameters

```

Network interfaces
interface_name: [eth0] # Interfaces for N3/N6/N9 traffic
xdp_attach_mode: native # generic|native|offload
n3_address: 10.100.50.233 # N3 interface IP
pfcpc_address: :8805 # PFCP listen address
pfcpc_node_id: 10.100.50.241 # PFCP Node ID

Capacity
max_sessions: 100000 # Maximum concurrent sessions

API and monitoring
api_address: :8080 # REST API port
metrics_address: :9090 # Prometheus metrics port

```

## Important Monitoring Thresholds

- **eBPF Map Capacity < 70%:** Normal operation

- **eBPF Map Capacity 70-90%:** Plan capacity increase within 1 week
- **eBPF Map Capacity > 90%:** Critical - immediate action required
- **Packet Drop Rate < 0.1%:** Excellent
- **Packet Drop Rate 0.1-1%:** Good - minor issues
- **Packet Drop Rate > 5%:** Critical - investigate immediately
- **XDP Aborted > 0:** Critical issue with eBPF program

## 3GPP Standards Reference

OmniUPF implements the following 3GPP specifications:

Specification	Title	Relevance
<b>TS 23.501</b>	System architecture for the 5G System (5GS)	5G UPF architecture and interfaces
<b>TS 23.401</b>	General Packet Radio Service (GPRS) enhancements for E-UTRAN access	LTE UPF (PGW-U) architecture
<b>TS 29.244</b>	Interface between the Control Plane and the User Plane nodes (PFCP)	N4 PFCP protocol
<b>TS 29.281</b>	General Packet Radio System (GPRS) Tunneling Protocol User Plane (GTPv1-U)	GTP-U encapsulation
<b>TS 23.503</b>	Policy and charging control framework for the 5G System (5GS)	QoS and charging
<b>TS 29.212</b>	Policy and Charging Control (PCC)	QoS enforcement

# Glossary

## 5G Architecture Terms

- **3GPP:** 3rd Generation Partnership Project - Standards body for mobile telecommunications
- **AMF:** Access and Mobility Management Function - 5G core network element for access control
- **CHF:** Charging Function - 5G charging system
- **DN:** Data Network - External network (Internet, IMS, enterprise)
- **eNodeB:** Evolved Node B - LTE base station
- **F-TEID:** Fully Qualified Tunnel Endpoint Identifier - GTP-U tunnel ID with IP address
- **gNB:** Next Generation Node B - 5G base station
- **GTP-U:** GPRS Tunnelling Protocol User Plane - Tunneling protocol for user data
- **MBR:** Maximum Bit Rate - QoS parameter for maximum allowed bandwidth
- **GBR:** Guaranteed Bit Rate - QoS parameter for guaranteed minimum bandwidth
- **N3:** Interface between RAN and UPF (user plane traffic)
- **N4:** Interface between SMF and UPF (PCF control)
- **N6:** Interface between UPF and Data Network (user plane traffic)
- **N9:** Interface between two UPFs (inter-UPF user plane traffic)
- **PCF:** Policy Control Function - 5G policy server
- **PDU:** Protocol Data Unit - Data session in 5G
- **PGW-C:** PDN Gateway Control Plane - LTE control plane equivalent to SMF
- **PGW-U:** PDN Gateway User Plane - LTE user plane (UPF equivalent)
- **QFI:** QoS Flow Identifier - 5G QoS flow marking
- **QoS:** Quality of Service - Traffic prioritization and bandwidth management
- **RAN:** Radio Access Network - Base station network (gNB/eNodeB)
- **SEID:** Session Endpoint Identifier - PCF session ID
- **SMF:** Session Management Function - 5G core network element for session control

- **TEID:** Tunnel Endpoint Identifier - GTP-U tunnel ID
- **UE:** User Equipment - Mobile device
- **UPF:** User Plane Function - 5G packet forwarding network element

## PFCP Protocol Terms

- **Association:** Control relationship between SMF and UPF
- **FAR:** Forwarding Action Rule - Determines packet forwarding behavior
- **IE:** Information Element - PFCP message component
- **Node ID:** UPF or SMF identifier (FQDN or IP address)
- **PDR:** Packet Detection Rule - Classifies packets into flows
- **PFCP:** Packet Forwarding Control Protocol - N4 control protocol
- **QER:** QoS Enforcement Rule - Applies bandwidth limits and marking
- **SDF:** Service Data Flow - Application-specific traffic filter
- **Session:** PFCP session representing UE PDU session or PDP context
- **URR:** Usage Reporting Rule - Tracks data volumes for charging

## eBPF and Linux Kernel Terms

- **BPF:** Berkeley Packet Filter - Kernel packet filtering technology
- **eBPF:** Extended BPF - Programmable kernel data path
- **Hash Map:** eBPF key-value store for fast lookups
- **XDP:** eXpress Data Path - Kernel packet processing at driver level
- **Verifier:** Kernel component that validates eBPF programs for safety
- **Map:** eBPF data structure shared between kernel and userspace
- **Zero-copy:** Packet processing without copying to userspace

## OmniUPF Product Terms

- **OmniUPF:** eBPF-based User Plane Function (this product)
- **Datapath:** Packet processing engine (eBPF programs)
- **Control Plane:** PFCP handler and session management
- **REST API:** HTTP API for monitoring and management
- **Web UI:** Browser-based control panel