

ANSI R226 規格

OmniTAS IMS 規格 R226-3 及び R226-7 規格 ANSI R226 規格

規格

規格 (ANSI)

R226 - 規格

1. 規格

1.1 規格

OmniTAS IMS 規格
規格 (TAS)
IMS (IP 規格) 規格
SIP, Diameter, HTTP/HTTPS, SS7/MAP
規格

規格

規格

- 規格 (SIP) 規格 B2BUA 規格
- IMS 規格 (iFC) 規格
- 規格
- 規格 (E.164 PSAP 規格)
- 規格 (CDR) 規格

規格

- 規格 IMS S-CSCF 規格 (SIP 規格 TCP/UDP)

- SBC/Proxy (SIP Proxy)
- **Diameter** Sh (Sh), Ro (Ro)
- **SS7** HLR/MSC Proxy MAP Proxy
- **HTTP/HTTPS** Proxy (SMS, TTS, MAP Proxy)

Database

- Database
- CDR Database
- Proxy (Sofia SIP)
- Database (SQLite)

1.2 SIP

1.2.1 SIP

SIP Proxy

- OmniTAS SIP IMS Proxy SIP Proxy
- SIP Proxy
 - From, P-Asserted-Identity
 - To, Request-URI
 - SIP URI Proxy
 - Proxy
 - SDP (SDP) Proxy

Database

- Database (CDR) Proxy
 - Proxy (Database)
 - Proxy (MSISDN, IMSI, SIP URI)
 - Proxy (Proxy/Proxy)
 - Proxy (Database)
 - Proxy
 - Proxy (Database)

IPsec (SIPREC)

- SIPREC IPsec
- SIP IPsec
- IPsec
- SIPREC IPsec
- SIPREC IPsec

1.2.2 IPsec

IPsec

- RTP IPsec B2BUA
- RTP IPsec
- IPsec
- SDP IPsec

IPsec

- SIP IPsec
- Diameter IPsec/Sh, Ro IPsec
- HTTP/HTTPS IPsec

1.2.3 IPsec

IPsec

- Web UI IPsec
 - IPsec (IPsec)
 - IPsec/IPsec
 - IPsec
 - IPsec
 - IPsec

IPsec

- IPsec CDR IPsec
 - IPsec

- 网络/设备
- 应用 (应用程序)
- 网络/设备
- 应用程序

网络

- 网络
- 网络/设备
 - IMS 网络 URI
 - P-Access-Network-Info 网络 (网络)
 - IP 网络
- 网络

应用

- 网络 (Prometheus 网络)
- 网络/设备
- Diameter 网络
- 网络

网络/设备 网络 [metrics.md](#) 网络/设备

网络

- 网络
- E.164 网络/设备 (网络)
- 网络 (PSAP 网络)

1.3 网络

1.3.1 网络

网络

- Diameter TLS 网络
- Web 网络 API 网络 HTTPS

- 认证 (认证)

认证

- Web UI 认证 (RBAC)
- SHA-512 认证 (65,532 认证)

认证

- 认证
- 认证
- 认证
- 认证

1.3.2 认证

认证

- 认证 TLS (认证)
- 认证
- 认证 (PFS) 认证

认证

- 认证 CDR 认证
- 认证
- 认证
- 认证 (认证/认证/认证)

认证

- 认证
- 认证
- 认证 (认证)

1.4 认证

认证

1. SIPREC 系统 (RFC 7866)

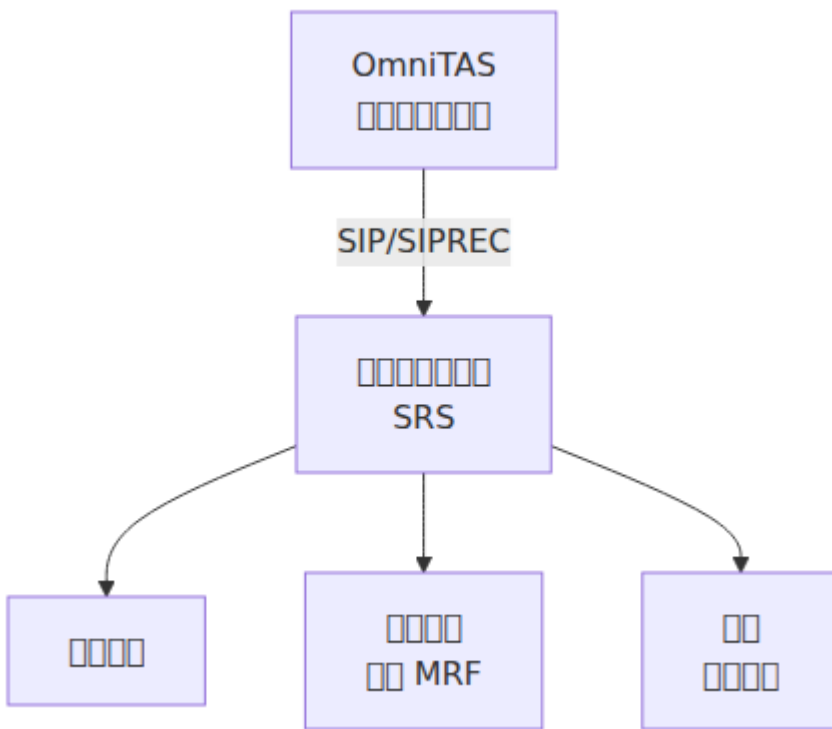

2. CDR 系统

- CDR 系统
- 系统 (CSV, JSON)
- 系统 (HTTPS)

3. 系统

- 系统
- 系统 CDR 系统 SQL 系统
- 系统
- 系统

4. API 系统

- 系统 RESTful API
- 系统
- 系统 CDR 系统
- 系统

系统

Identifiers

- Identifiers (MSISDN, IMSI, SIP URI)
- Identifiers
- Identifiers/Identifiers SIPREC Identifiers

Identifiers

- Identifiers
- Identifiers
- Identifiers (Identifiers)

Identifiers

- Identifiers
- Identifiers
- Identifiers

2. Identifiers

2.1 Identifiers

OmniTAS IMS Identifiers Identifiers Identifiers ANSSI Identifiers

2.2 Identifiers

2.2.1 TLS/SSL Identifiers

Identifiers

- TLS 1.2 (RFC 5246)
- TLS 1.3 (RFC 8446)
- SSL 2.0/3.0 Identifiers (Identifiers)
- TLS 1.0/1.1 Identifiers (Identifiers)

Identifiers (Identifiers)

☐☐ - TLS 1.3☐

- TLS_AES_256_GCM_SHA384
- TLS_CHACHA20_POLY1305_SHA256
- TLS_AES_128_GCM_SHA256

☐☐ - TLS 1.2☐

- TLS_ECDHE_RSA_WITH_AES_256_GCM_SHA384
- TLS_ECDHE_RSA_WITH_AES_128_GCM_SHA256
- TLS_ECDHE_RSA_WITH_CHACHA20_POLY1305_SHA256
- TLS_DHE_RSA_WITH_AES_256_GCM_SHA384
- TLS_DHE_RSA_WITH_AES_128_GCM_SHA256

☐☐☐☐☐

- ☐☐☐☐☐☐☐☐☐ (PFS)
- ☐ Diffie-Hellman ☐ (2048 ☐☐☐)
- ☐☐☐☐☐☐☐☐☐ NIST P-256, P-384, P-521
- ☐☐☐☐☐☐☐☐☐ (SNI)
- ☐☐☐☐☐ OCSP stapling

☐☐☐☐☐

- ☐☐ X.509 ☐☐
- RSA ☐☐☐☐☐2048 ☐☐☐☐☐4096 ☐☐☐☐
- ☐☐ ECDSA (P-256, P-384)
- ☐☐☐☐☐☐☐
- CRL ☐ OCSP ☐☐☐☐☐
- ☐☐☐☐☐☐☐☐☐☐ (☐☐☐☐☐☐☐☐)
- ☐☐ CA ☐☐

☐☐☐☐

- Web UI ☐ API ☐☐☐☐☐ HTTPS
- Diameter ☐☐ TLS

2.3 数据库加密

2.3.1 数据库加密

SQLite 加密

- 使用 SQLCipher 加密
- AES-256 加密
- 加密数据库文件 (CDR, 数据库)

2.3.2 数据库加密

数据库加密

- CDR 使用 AES-256 加密 (加密)
- 加密数据库文件
- 加密数据库文件 (PKCS#12, PEM 加密)
- 加密数据库文件

数据库加密

- 加密数据库文件
- 加密数据库文件

2.4 数据库加密与解密

2.4.1 数据库加密

数据库加密 SHA-512 加密

数据库加密

- 加密数据库 (128 加密)
- 65,532 加密数据库 (加密)
- 加密数据库
- 加密数据库

数据库加密

```
$6$rounds=65532$<salt>$<hash>
```

□□□

- Web UI □□□□□□
- API □□□□
- □□□□□□□□
- □□□□□□□□

2.4.2 SSH □□□□□□

□□□□□□□□

- RSA□1024-4096 □ (□□ 2048 □□□)
- DSA□1024-4096 □ (□□□□□□ RSA)
- ECDSA□P-256, P-384, P-521 □□
- Ed25519□256 □ (□□□□□□)

□□□□□□

- □□□□□□□□□□
- □□□□□□□□□□□□□□
- □□□□□□□□□□
- □□□□□□□□
- □□□□□□□□

SSH □□□

- □□□ SSH-2 □□ (□□ SSH-1)
- □ MAC □□ (HMAC-SHA2-256, HMAC-SHA2-512)
- □□□□□curve25519-sha256, ecdh-sha2-nistp256, diffie-hellman-group14-sha256

2.5 Diameter □□□□□

2.5.1 Diameter □□□□□

□□□□

- Diameter □□□□ TLS □□ TCP
- □□□□□□□□

□□□□□□

- □□ Origin-Host/Origin-Realm □□□□□□□□□□
- □□□□□□ (□□□□□□)
- □□□□□ AVP (□□-□□) □□
- □□ CMS (□◆◆□□□□) □□□□□□

2.6 SIP □□□□

P-Asserted-Identity□

- □□□□□□
- □□□□□□□□
- □□□□□□

□□□ □□□□□□□ IMS □□ (P-CSCF/S-CSCF) □□□□□□ TAS□

2.7 □□□□□□□□□□□□

2.7.1 □□□□□□

□□□□□□□□

- SIP □□□□□□□□□□/□□□□
- Diameter □□□□□□ (AVP □□)
- TLS □□□□□
- □□□□□□□□

□□□□□□

- Wireshark/tcpdump □□□□□□□□
- SSLKEYLOGFILE □□□□□ TLS □□ (□□□□□□)
- PCAP □□□□□□□□□□

2.7.2 认证

认证

- SIP 认证 MD5 认证 (认证)
- 认证 (认证)
- 认证 (认证/认证)

认证

- 认证
- 认证
- 认证
- 认证

2.8 认证

2.8.1 认证

认证

- RSA 认证 OpenSSL 认证 (认证 FIPS 140-2 认证)
- 认证/dev/urandom (Linux 认证 CSPRNG)
- 认证 RNG 认证

2.8.2 认证

认证

- 认证 (0600)
- 认证 PEM 认证
- 认证

认证

- 认证
- 认证
- 认证 (认证)

2.8.3 安全

安全

- Web UI 安全
- API 安全
- ACME 协议 (Let's Encrypt)

安全

- Diameter 安全
- TLS 和 Diffie-Hellman 安全
- 安全

2.9 安全

安全

- NIST SP 800-52 和 TLS
- NIST SP 800-131A
- RFC 7525 和 TLS
- ETSI TS 133 310 和 IMS
- 3GPP TS 33.203 和 IMS

安全

- 安全 (安全)
- ANSSI 安全 (安全)
- 安全 (安全)

2.10 安全

2.10.1 安全

安全

- 安全/安全
- 安全

- 0000000000000000
- 0000000000

2.10.2 0000

00000

- TLS 0000 (0000)
- 000000 (0000 TLS)
- 000000 (0000)

000000

- 0000000000000000
- 0000000
- 0000000000000000
- 0000000000000000

3. 00000000

3.1 0000000000

00000

- 00000000000000000000
- SIPREC 0000000000000000
- CDR 0000000000000000
- 0000000000000000

0000000

- 000000 (0000000)
- 0000000000
- 000000000000
- 000000000000

3.2 呼叫记录

呼叫记录

- CDR 记录 (每 90 秒记录 1 条)
- 记录内容
- 记录格式 1 示例
- 记录内容

呼叫记录

- 记录内容
- 记录 (记录内容)
- 记录内容

3.3 呼叫记录

呼叫记录

- 记录 ETSI LI (记录) 记录 (记录内容)
- SIPREC 记录 LI 记录
- 记录 X1-X2-X3 记录 (记录)

呼叫记录

- IRI (记录)记录 CDR 记录
- CC (记录)记录 SIP 记录 + 记录 (记录 MRF)
- 记录 XMLJSON 记录

4. 呼叫记录

4.1 呼叫记录

呼叫记录

- 標準規格 (ANSI R226 等)
- 標準規格
- 標準規格
- 標準規格

4.2 標準規格

標準規格

- 標準規格 (SIP, Diameter, HTTPS)
- 標準規格
- IP 標準/規格

4.3 標準規格

標準規格

- 標準規格
- 標準規格
- 標準 Diameter 規格
- 標準規格 (SIEM 等)

5. 標準規格

5.1 標準規格

標準規格

- **README.md** 標準規格
- **doc/deployment_guide.md** 標準規格 (標準)
- **doc/configuration.md** 標準規格 (標準)

5.2 詳細

- 詳細 [詳細]
- 詳細 [詳細]
- 詳細 OpenSSL FIPS 140-2 詳細

5.3 詳細

- **ANSI R226** 詳細 詳細
 - 詳細 詳細
-

6. 詳細

詳細/詳細

- 詳細 Omnitouch Network Services Pty Ltd
- 詳細 PO BOX 296, QUINNS ROCKS WA 6030, AUSTRALIA
- 詳細
- 詳細 compliance@omnitouch.com.au

詳細

- 詳細
- 詳細 compliance@omnitouch.com.au

詳細/詳細

-  詳細
 - 詳細 compliance@omnitouch.com.au
-

□□

□□ **A: SIP** □□□□□

A.1 □□□□□□□□□□

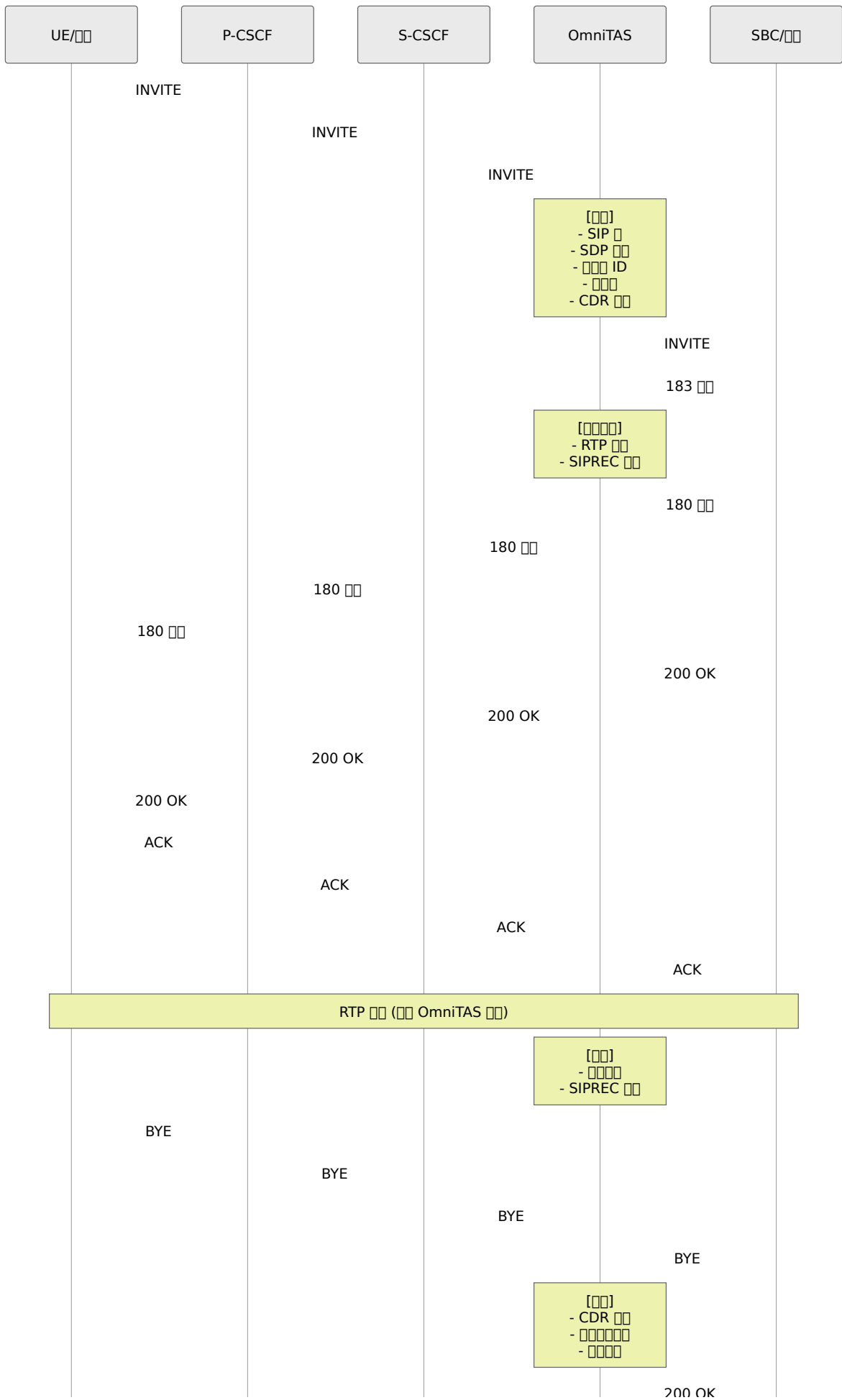

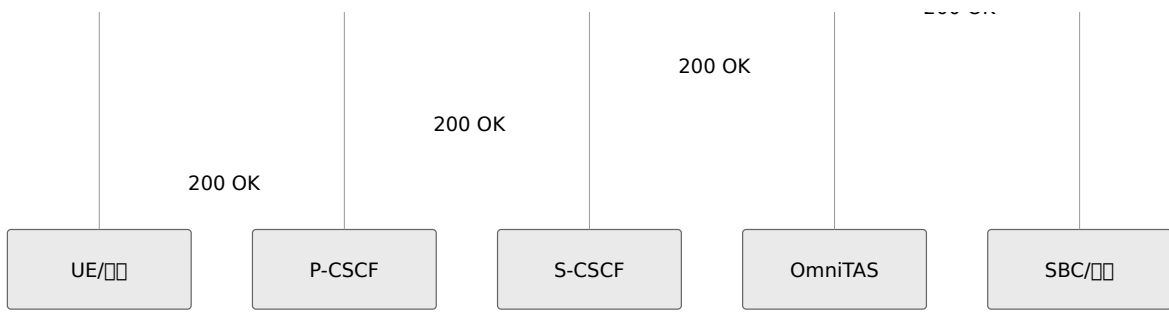

□□□ [□□] = □□□□□□□□□□

A.2 □□□□□□□□□□

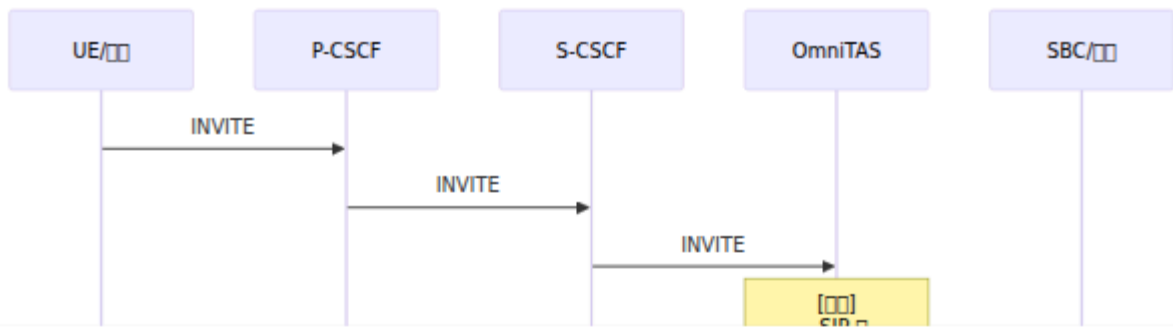

OmniCharge OmniRAN Downloads Omnitouch Website

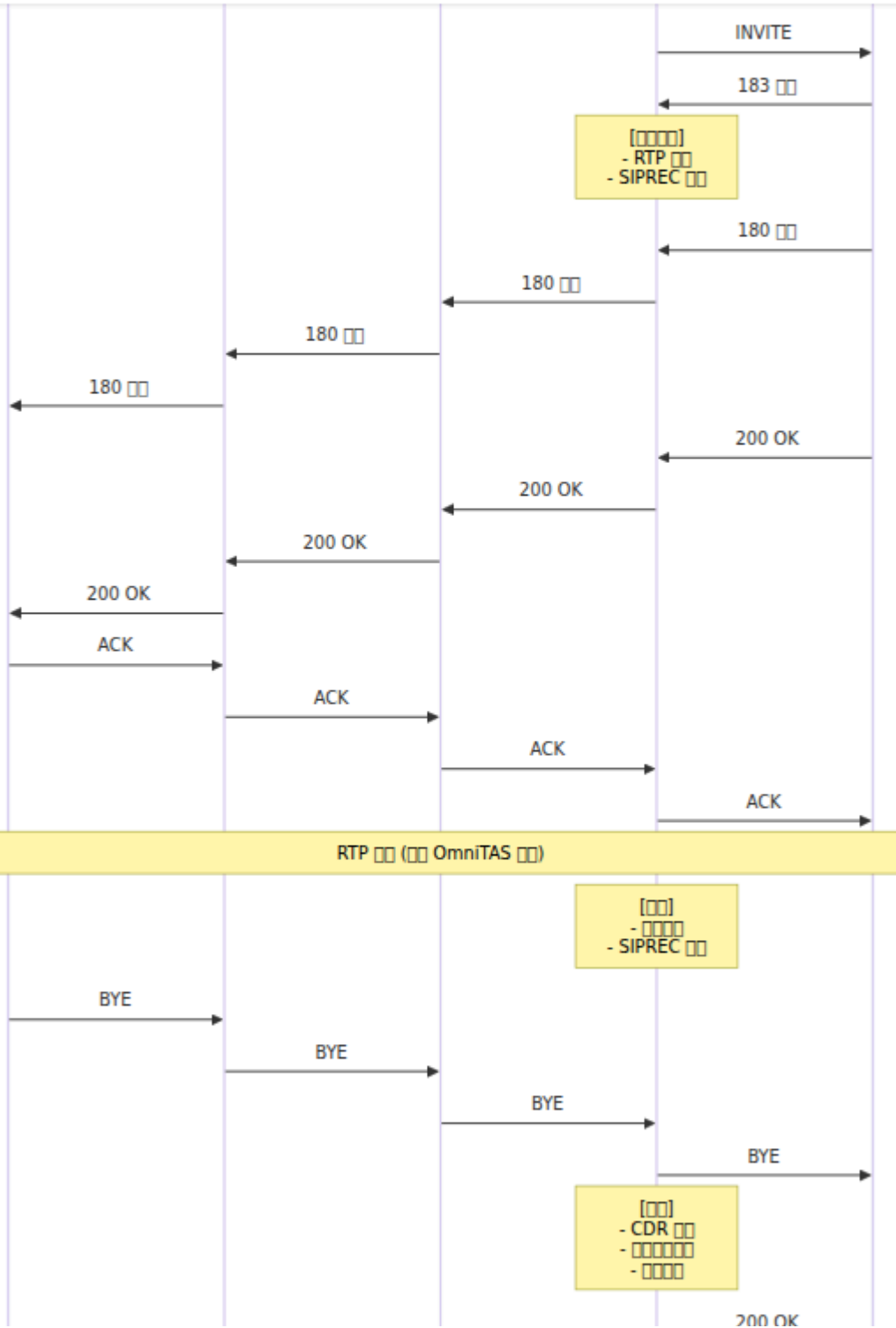

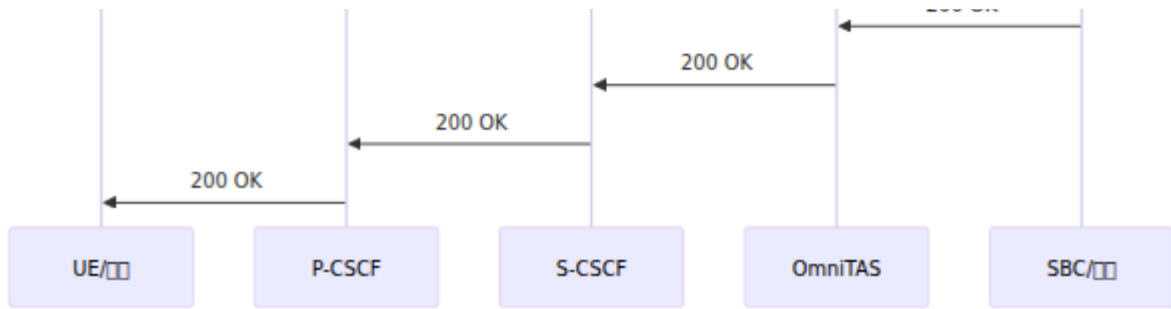

A.3 SIPREC

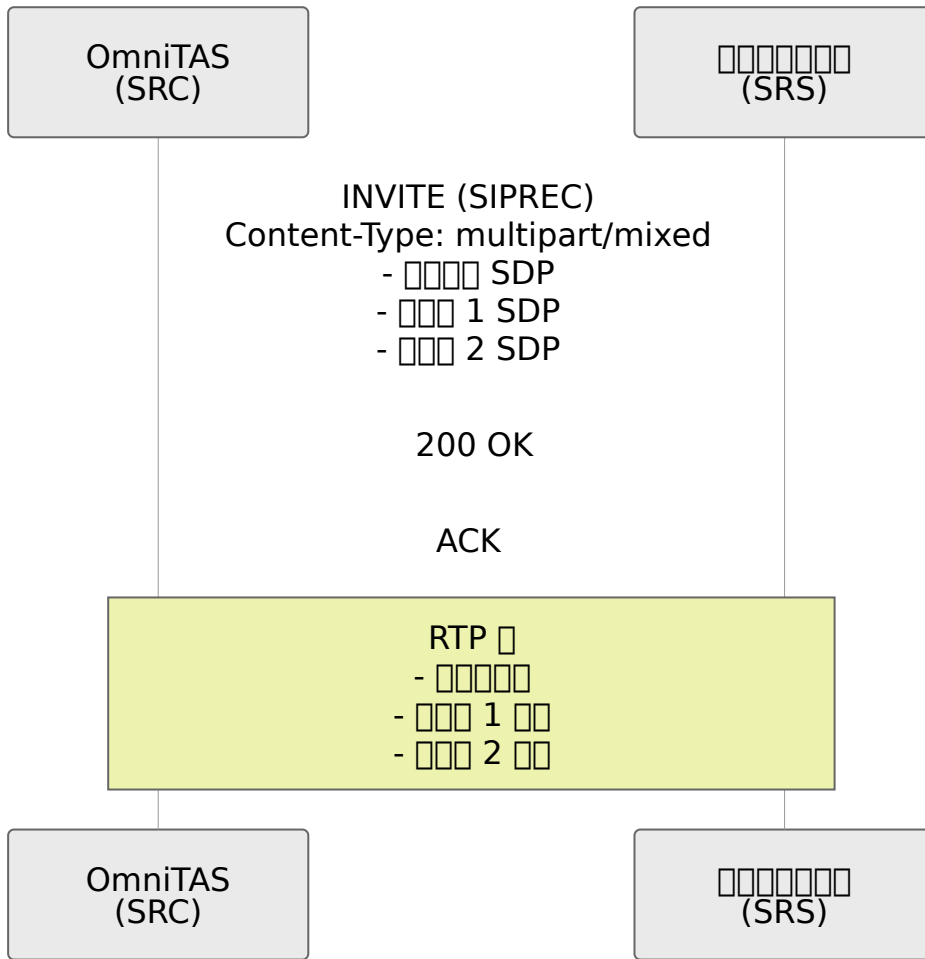

B: CDR

OmniTAS uses `/etc/freeswitch/db/cdr.db` SQLite database (FreeSWITCH CDR DB)

B.1 SRS CDR

項目名	型別	説明	単位
uuid	TEXT	ユニーク識別子	文字列
caller_id_number	TEXT	発信者番号 (MSISDN)	文字列
caller_id_name	TEXT	発信者名前	文字列
destination_number	TEXT	宛先番号	文字列
start_stamp	DATETIME	開始時刻	時刻
answer_stamp	DATETIME	応答時刻	時刻
end_stamp	DATETIME	終了時刻	時刻
duration	INTEGER	通話時間 (秒)	秒
billsec	INTEGER	課金時間 (秒)	秒
hangup_cause	TEXT	通話終了原因	文字列
sip_hangup_disposition	TEXT	SIP 通話終了理由	文字列
network_addr	TEXT	ネットワーク IP アドレス	文字列
sip_from_user	TEXT	SIP From 番号	文字列
sip_to_user	TEXT	SIP To 番号	文字列
sip_call_id	TEXT	SIP Call-ID	SIP 文字列

B.2 CDR 項目

項目名

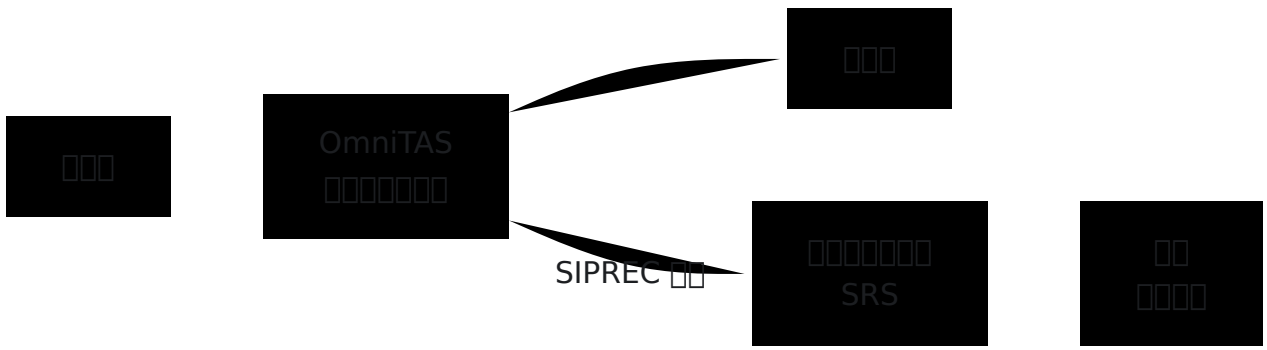

C.2 SIPREC

SIPREC

SIPREC

- SIPREC (caller_id_number)
- SIPREC (destination_number)
- SIP URI

SIPREC

- SIPREC (911, 112)
- SIPREC
- SIPREC

SIPREC

- SIPREC (P-Access-Network-Info)
- IP SIPREC

C.3 SIPREC

SIPREC SRS

SIPREC

- SIP (From, To, P-Asserted-Identity)
- ID
- SIPREC
- SIPREC/SIPREC

□□□□

- □□□ 1 RTP □ (□□□□□)
- □□□ 2 RTP □ (□□□□□)
- □□□□□□
- DTMF □□

C.4 □□□□□□

□□□□□□□□□□

- **X1** □□□ □□□□ (□□□□□)
- **X2** □□□ □□□□□□ (IRI) - □□□□□
- **X3** □□□ □□□□ (CC) - □□□□□

OmniTAS □□□□□□□□□□ (SRC)□□□□□□□□□□ IRI □ CC □□□ SRS□□□□□□□□□□□□

□□ **D:** □□□□□□□

D.1 □□□□

□□ **TLS** □□□

```
# □□□□
openssl genrsa -out server.key 4096

# □□□□□□□□□□
openssl req -new -key server.key -out server.csr

# □□□□□□ (□□□□□)
openssl x509 -req -days 365 -in server.csr -signkey server.key -
out server.crt

# □□□□□□□□□□ CA □□□□□
```

□□□ SIP □□□ IMS □□□ TLS□SIP □□□□□□□□□ TCP/UDP□

D.2 Web UI □ HTTPS □□

API/Web TLS (config/runtime.exs)

```
config :api_ex,
  api: %{
    enable_tls: true,
    tls_cert_path: "priv/cert/server.crt",
    tls_key_path: "priv/cert/server.key",
    tls_versions: [:"tlsv1.2", :tlsv1.3],
    ciphers: [
      "ECDHE-RSA-AES256-GCM-SHA384",
      "ECDHE-RSA-AES128-GCM-SHA256",
      "TLS_AES_256_GCM_SHA384",
      "TLS_AES_128_GCM_SHA256"
    ]
  }
}
```

D.3 SIP

SIP TCP/UDP TLS

FreeSWITCH SIP

```
<!-- SIP TCP/UDP -->
<profile name="external">
  <settings>
    <param name="sip-port" value="5060"/>
    <param name="context" value="public"/>
  </settings>
</profile>
```

D.4 Diameter TLS

Diameter TLS

```
# Dialer TLS
config :diameter_ex,
  peers: [
    %{
      host: "dra.example.com",
      port: 3868,
      transport: :tls,
      tls_opts: [
        certfile: "priv/cert/diameter.crt",
        keyfile: "priv/cert/diameter.key",
        cacertfile: "priv/cert/ca.crt",
        verify: :verify_peer
      ]
    }
  ]
]
```

D.5 `SQLCipher`

`SQLCipher` `SQLite`

```
# config/runtime.exs
config :exqlite,
  encryption: true,
  encryption_key: System.get_env("DB_ENCRYPTION_KEY")
```

SQLite 3.38.1

D.6 `pbkdf2_elixir`

`SHA-512`

```
# config/runtime.exs
config :pbkdf2_elixir,
  rounds: 65_532,
  salt_len: 16
```

`SHA-512` - `SHA-256`

☐☐ **E:** ☐☐☐

☐☐☐☐☐☐

- **ANSI**☐ ☐☐☐☐☐☐☐☐☐ - ☐☐☐☐☐☐☐☐☐
- **ETSI**☐ ☐☐☐☐☐☐☐☐☐
- **3GPP**☐ ☐☐☐☐☐☐☐☐☐ - ☐☐☐☐☐☐☐☐☐
- **IETF**☐ ☐☐☐☐☐☐☐☐☐ - ☐☐☐☐☐☐☐☐☐

IMS ☐☐☐☐

- **IMS**☐ IP ☐☐☐☐☐☐☐ - ☐☐☐☐☐☐☐☐☐ IP ☐☐☐☐
- **CSCF**☐ ☐☐☐☐☐☐☐☐☐ - IMS ☐☐☐☐ SIP ☐☐☐☐
 - **P-CSCF**☐ ☐☐-CSCF - UE ☐☐☐☐☐☐☐☐☐SIP ☐☐
 - **I-CSCF**☐ ☐☐-CSCF - ☐☐☐☐☐☐☐☐☐☐
 - **S-CSCF**☐ ☐☐-CSCF - ☐☐☐☐☐☐☐☐☐☐
- **HSS**☐ ☐☐☐☐☐☐☐ - ☐☐☐☐☐☐
- **TAS**☐ ☐☐/☐☐☐☐☐☐☐☐☐ - ☐☐☐☐☐☐☐☐☐

☐☐☐☐☐

- **SIP**☐ ☐☐☐☐☐☐ (RFC 3261) - ☐☐☐☐☐/☐☐☐☐☐☐☐☐☐☐☐☐
- **SDP**☐ ☐☐☐☐☐☐☐ (RFC 4566) - ☐☐☐☐☐☐☐☐☐
- **RTP**☐ ☐☐☐☐☐☐☐ (RFC 3550) - ☐☐☐☐☐☐☐☐☐
- **RTCP**☐ RTP ☐☐☐☐☐ - RTP ☐☐☐☐☐☐☐☐☐
- **SRTP**☐ ☐☐ RTP (RFC 3711) - ☐☐☐☐☐☐☐☐☐
- **Diameter**☐ ☐☐ IMS ☐ AAA ☐☐ (☐☐☐☐☐☐☐☐☐☐☐☐)
 - **Sh**☐ Diameter ☐☐☐☐☐☐☐☐☐☐☐☐☐☐☐
 - **Ro**☐ Diameter ☐☐☐☐☐☐☐☐☐☐☐☐☐☐☐
- **SIPREC**☐ ☐☐☐☐☐☐☐☐☐ (RFC 7866) - ☐☐☐☐☐☐☐☐☐☐

☐☐☐☐

- **SBC**☐ ☐☐☐☐☐☐☐☐☐ - ☐☐☐☐☐☐☐☐☐☐☐☐☐☐☐☐
- **MRF**☐ ☐☐☐☐☐☐☐☐☐ - ☐☐☐☐☐ (☐☐☐☐☐☐☐☐☐☐☐☐☐☐☐)
- **UE**☐ ☐☐☐☐☐☐☐☐☐ - ☐☐☐☐☐☐☐☐☐☐☐☐☐☐☐☐

- **PSAP** 00000000 - 00000000
- **DRA** Diameter 0000 - Diameter 0000

0000

- **LI** 0000 - 00000000
- **IRI** 000000 - 00000000
- **CC** 0000 - 0000/0000
- **SRC** 00000000 - SIPREC 000 (OmniTAS 00)
- **SRS** 00000000 - SIPREC 0000000000
- **X1** 000 LI 0000 (0000)
- **X2** 000 LI 0000 IRI 00
- **X3** 000 LI 0000 CC 00
- **R226** 000000 R226-3 0 R226-7 0000000000

0000

- **CDR** 0000000 - 000000000000
- **B2BUA** 0000000 - 000000000000 SIP 00
- **DTMF** 0000 - 000000
- **MSISDN** 0000000000000000 - 000000
- **IMSI** 0000000000 - 00000000
- **E.164** 0000000000

000000

- **TLS** 000000 (RFC 5246, RFC 8446) - 00000
- **PFS** 0000000 - 0000000000000000
- **SHA-512** 000000000000 512 0
- **AES** 00000000
- **RSA** Rivest-Shamir-Adleman - 00000000
- **ECDSA** 000000000000
- **PKI** 00000000 - 00000000
- **CA** 00000000 - 00000000
- **CRL** 00000000

- **OCSP** 証明書

その他

- **MAP** 証明書 - SS7 証明書
- **HLR** 証明書 - 証明書 ()
- **SS7** 証明書 7 - 証明書
- **NANP** 証明書
- 証明書 **ID** 証明書

その他

- **SQLite** 証明書
- **SQLCipher** SQLite 証明書
- **CSV** 証明書 - 証明書
- **JSON** JavaScript 証明書 - 証明書
- **XML** 証明書 - 証明書

その他

- **API** 証明書 - 証明書
- **UI** 証明書 - Web 証明書
- **RBAC** 証明書 - 証明書
- **UUID** 証明書 - 証明書

証明書 1.0

2025-11-29

ANSI R226 証明書

証明書 証明書 - 証明書

□□□□

□ □□□□

□□□□TAS□□□□□□□□□□

□□□□

□□□□

- □ **README** - □□□□□□
- □ □□□□ - □□□□□□
- □ □□□□ - Prometheus□□□□□

□□□□

- □ **Sh**□□ - □HSS/□□□□□□□□□□
- □ □□□□**Ro**□ - OCS□□□□□□□□
- □ **SS7 MAP** - □□□□□□□□□□HLR□□

□□□□

- □ □□□□□□ - XML□□□□□□□□□□□□
- □ □□□□ - E.164□□□□□□
- ⚙️ □□□□ - □□□□□□CLI□□□□□□□□

□□□□

- □ □□□□ - □□□□□□□□□□□□□□
- □ **TTS**□□ - □□□□□□□□□□
- □ **IMS**□□□□□ - □□□□□

- `host` `"127.0.0.1"` `localhost`
- `host` `localhost`
- `host` `IP`
- `host` `"10.8.82.60"` `IP`
- `port` (TCP)
 - `port` `8021`
 - `port` `8021`
 - `port` `8021`
 - `port` `8021`
- `secret` (secret)
 - `secret`
 - `secret` `ESL`
 - `secret` `secret`
 - `secret` `"cd463RZ8qMk9AHMMDGT3V"`

API

- `API`
- `API` `/calls` `API`
- `API`
- `API`
- `API`

API

- `TAS` `API`
- `API`
- `API`
- `API`

API

- `secret` `secret`

- TAS
- TAS localhost
-

Configuration

-
- secret
-
- TAS

Deployment

Web TAS CDR Diameter

config/runtime.exs

```

config :control_panel,
  page_order: ["/application", "/configuration"]

config :control_panel, ControlPanelWeb.Endpoint,
  url: [host: "0.0.0.0", path: "/"],
  https: [
    port: 443,
    keyfile: "priv/cert/server.key",
    certfile: "priv/cert/server.crt"
  ]

```

Configuration

Configuration

- **page_order** (list)
 -
 - ["/application", "/configuration"]
 -

Web

- **url** (URL) (URI) URL
 - **host** URL "tas.example.com" "0.0.0.0"
 - **path** "/"
 - URL
- **https** (HTTPS/TLS)
 - **port** (HTTPS) 443
 - **keyfile** (TLS) PEM
 - **certfile** (TLS) PEM
 - TAS

TLS HTTPS

1. /

```
openssl req -x509 -newkey rsa:4096 -keyout priv/cert/server.key \
-out priv/cert/server.crt -days 365 -nodes
```

2.

- CA
- Let's Encrypt CA
-
- `chmod 600`

-
- MSISDN
- Diameter

- 配置 SSL 证书

配置 SSL

- 配置 SSL 证书
- 配置 CA 证书
- 配置 IP 地址
- 配置 SSL 证书
- 配置 SSL 证书
- 配置 HTTPS - 配置 HTTP 证书

配置 SSL

1. 配置 SSL

```
url: [host: "10.8.82.60", path: "/"] # 配置 SSL
```

2. 配置 SSL

```
url: [host: "tas.operator.com", path: "/"]  
https: [port: 443, ...]
```

3. 配置 SSL

```
url: [host: "tas.internal", path: "/panel"] # Nginx/Apache 配置
```

配置 SSL

- 配置 SSL 证书 `keyfile` `certfile` 配置 SSL 证书
 - 配置 SSL 证书 配置 SSL 证书 443 配置 SSL 证书
 - 配置 UI 配置 SSL 证书 HTTPS 配置
 - **SSL** 配置 SSL 证书 PEM 配置
-

API

TAS REST API OpenAPI/Swagger TLS

config/runtime.exs

```
config :api_ex,
  api: %{
    port: 8444,
    listen_ip: "0.0.0.0",
    product_name: "OmniTAS",
    title: "API - OmniTAS",
    hostname: "localhost",
    enable_tls: true,
    tls_cert_path: "priv/cert/server.crt",
    tls_key_path: "priv/cert/server.key"
  }
```

- **port** (API TCP)
 - 8444
 -
 - HTTPS 443 API
 - 8444 8443 9443
- **listen_ip** (API IP)
 - "0.0.0.0"
 - "127.0.0.1" localhost
 - IP "10.8.82.60"
 - API "127.0.0.1"
- **product_name** (API)
 - API
 - "OmniTAS" "MyOperator-IMS"

- **title** (名前) APIのタイトル
 - OpenAPI/Swagger UIの表示
 - 例 "API - OmniTAS" "IMSのAPI"
- **hostname** (名前) APIのホスト名
 - OpenAPIのURL
 - APIのドメイン
 - 例 "localhost" "api.operator.com" "10.8.82.60"
- **enable_tls** (有無) APIのTLS/HTTPS
 - true HTTPS API
 - false HTTP API
 - 例 true
- **tls_cert_path** (名前) TLSの証明書PEM
 - enable_tls: true
 - TASの証明書
 - 例 "priv/cert/server.crt"
- **tls_key_path** (名前) TLSの秘密鍵PEM
 - enable_tls: true
 - TASの秘密鍵
 - 例 chmod 600
 - 例 "priv/cert/server.key"

API

REST API

-
- CDR
-
- Diameter
-

- `listen_ip`
- `enable_tls`

OpenAPI/Swagger

API Swagger OpenAPI Swagger

- Swagger UI `https://hostname:port/api/swaggerui`
- OpenAPI JSON `https://hostname:port/api/openapi`
- API
- /

- API
- API
- **TLS** `enable_tls: true`
- API
- API
- API

```
# curl API
curl -k https://localhost:8444/api/health

# Swagger
https://localhost:8444/api/swaggerui
```

1. API

```
listen_ip: "127.0.0.1" # localhost
enable_tls: false     # HTTP
```

2. TLS API

```
listen_ip: "0.0.0.0" # 0.0.0.0
enable_tls: true # HTTPS
hostname: "api.operator.com"
```

3. 0.0.0.0

```
listen_ip: "0.0.0.0"
enable_tls: false # HTTP
port: 8080 # 8080
```

0.0.0.0

- 0.0.0.0 0.0.0.0 root <1024
- **TLS** 0.0.0.0
- 0.0.0.0
- 0.0.0.0 hostname CN SAN
- **API 404** API

SIP

Ansible XML

CSCF IP/SBC

allowed_sbc_source_ips MT CSCF allowed_cscf_ips MO

TAS MO MT TAS IP IP

```
config :tas,
  allowed_sbc_source_ips: ["10.5.198.200", "103.26.174.36"],
  allowed_cscf_ips: ["10.8.3.34"],
```

Web UI

- SIP

- SIP
- SIP
-
- Ping SIP OPTIONS SIP OPTIONS
-
- / / /
- SIP OPTIONS ping
- SIP OPTIONS ping
- _ _

XML SBC PSTN SIP

```

<include>
  <gateway name="carrier_trunk">
    <param name="proxy" value="203.0.113.50;transport=tcp"/>
    <param name="register" value="true"/>
    <param name="caller-id-in-from" value="true"/>
    <param name="username" value="trunk_user"/>
    <param name="password" value="secure_password"/>
    <param name="register-transport" value="tcp"/>
    <param name="retry-seconds" value="30"/>
    <param name="ping" value="25"/>
  </gateway>
</include>

```

□□□□□□□□

```
<include>
  <gateway name="sbc_static">
    <param name="proxy" value="198.51.100.10"/>
    <param name="register" value="false"/>
    <param name="caller-id-in-from" value="true"/>
  </gateway>
</include>
```

□□□□

□□□□

name (□□□□)

- □□□□□□□□□□
- □□□□□□□□□□ `sofia/gateway/name/destination`
- □□□ `<gateway name="my_trunk">`

proxy

- SIP□□/□□□IP□□□□□□□□
- □□□□□□□□□□□□
- □□□
 - `value="203.0.113.50"` □□□□□5060□UDP□
 - `value="203.0.113.50:5061"` □□□□□□□□
 - `value="203.0.113.50;transport=tcp"` □TCP□□□□
 - `value="203.0.113.50:5061;transport=tls"` □TLS□□□□5061□□

register

- □□□□□□□□SIP□□
- □□ `true` | `false`
- □□□□□□□□□□□□□□ `true`
- □□□□□□□□IP□□□□□□□□□□ `false`

□□□□□□□□

username

- SIP
-
- register="true"
- value="trunk_account_123"

password

- SIP
-
- register="true"
- value="MySecureP@ssw0rd"

realm

- SIP
- -
- value="sip.carrier.com"

auth-username

- username
- - From
- value="auth_user_456"

register-transport

-
- udp | tcp | tls
- proxy
- value="tcp"

register-proxy

-

- 注册失败时重试
- `value="register.carrier.com:5060"`

retry-seconds

- 注册失败时重试
- 默认值 30
- 范围 5 ~ 3600
- `value="30"`

expire-seconds

- 注册失败时重试
- 默认值 3600 ~ 1
- 范围 1 ~ 3600
- `value="1800" ~ 30`

caller-id-in-from

- SIP From 头域
- `true | false`
- `true` 从 From 头域中获取
- `false` 从 From 头域中不获取
- 默认值 `true`
- `value="true"`

其他

ping

- N 个 SIP OPTIONS ping
- 默认值 25
- 范围 0 ~ 255
- 范围 15 ~ 60
- 默认值 UI 中的“Ping”
- `value="25"`

ping-max

- ping-max 参数
- ping 参数
- value="3"

ping-max

extension

- extension 参数
- extension - 参数
- value="+12125551234"

extension-in-contact

- Contact 参数
- true | false
- false
- value="false"

contact-params

- Contact 参数
- 参数
- value="line=1;isup=true"

contact-params

from-user

- From 参数
- 参数
- value="trunk_pilot"

from-domain

- From 参数
- 参数

- `value="my-domain.com"`

outbound-proxy

- SIP
- `proxy` - `Route`
- `value="edge-proxy.carrier.com:5060"`

context

-
- `public`
-
- `value="from-carrier"`

channels

-
-
-
- `value="100"`

dtmf-type

- DTMF
- `rfc2833` | `info` | `inband` | `auto`
- `rfc2833`
- `rfc2833` RTP
- `info` SIP INFO
- `inband`
- `value="rfc2833"`

rtp-timeout-sec

- N RTP
- `0`
-

- `value="120"`

`rtp-hold-timeout-sec`

- RTP保持時間
- 0
- `value="1800"` 30

SIP

`sip-port`

- SIP
-
-
- `value="5060"`

`rtp-ip`

- RTP IP
- RTP IP
- `value="10.0.0.5"`

`register-proxy-port`

-
-
- `value="5061"`

`contact-host`

- Contact
- NAT
- `value="public-ip.example.com"`

`distinct-to`

- URI To
- `true` | `false`

- 布尔值
- 取值 `value="false"`

cid-type

- 远程-Party-ID 或 P-Asserted-Identity 标识符
- 取值 `rpuid` | `pid` | `none`
- `rpuid` 远程-Party-ID
- `pid` P-Asserted-Identity
- 取值 `value="pid"`

extension-in-contact

- 是否包含 Contact URI
- 取值 `true` | `false`
- 取值 `value="true"`

其他

transport (代理)

- 代理
- 取值 `udp` | `tcp` | `tls` | `ws` | `wss`
- 代理地址
- 取值 `proxy="203.0.113.50;transport=tcp"`

关于 TLS 和 SIP 代理

其他

```

<include>
  <gateway name="primary_carrier">
    <!-- 代理 -->
    <param name="proxy"
value="sbc.carrier.com:5060;transport=tcp"/>
    <param name="register" value="true"/>

    <!-- 认证 -->
    <param name="username" value="customer_trunk_01"/>
    <param name="password" value="SecurePassword123"/>

    <!-- 注册 -->
    <param name="register-transport" value="tcp"/>
    <param name="expire-seconds" value="1800"/>
    <param name="retry-seconds" value="30"/>

    <!-- 呼叫者ID -->
    <param name="caller-id-in-from" value="true"/>

    <!-- ping -->
    <param name="ping" value="30"/>

    <!-- 编解码 -->
    <param name="codec-prefs" value="PCMU,PCMA,G729"/>
    <param name="dtmf-type" value="rfc2833"/>

    <!-- 通道 -->
    <param name="channels" value="100"/>

    <!-- RTP -->
    <param name="rtp-timeout-sec" value="300"/>
  </gateway>
</include>

```

代理

认证 `sofia/gateway/name/destination` 代理

```

<!-- 配置名称 -->
<action application="bridge" data="sofia/gateway/primary_carrier/+121

<!-- 配置名称 -->
<action application="bridge" data="sofia/gateway/primary_carrier/ta

<!-- 配置名称SIP -->
<action application="bridge" data="{sip_h_X-Custom=Value}sofia/gatewa

<!-- 配置名称 -->
<action application="bridge"
data="sofia/gateway/primary_carrier/${tas_destination_number}|sofia/g

```

配置名称

配置名称

- `username` `password`
- `proxy`
- `register-transport`
-

配置名称

- Web UI `/gw`
- `caller-id-in-from`
- `codec-prefs`
- SIP RTP

配置名称

- `ping`
- `rtp-timeout-sec`
-
-

Diameter

Diameter

Ro Ro

Diameter

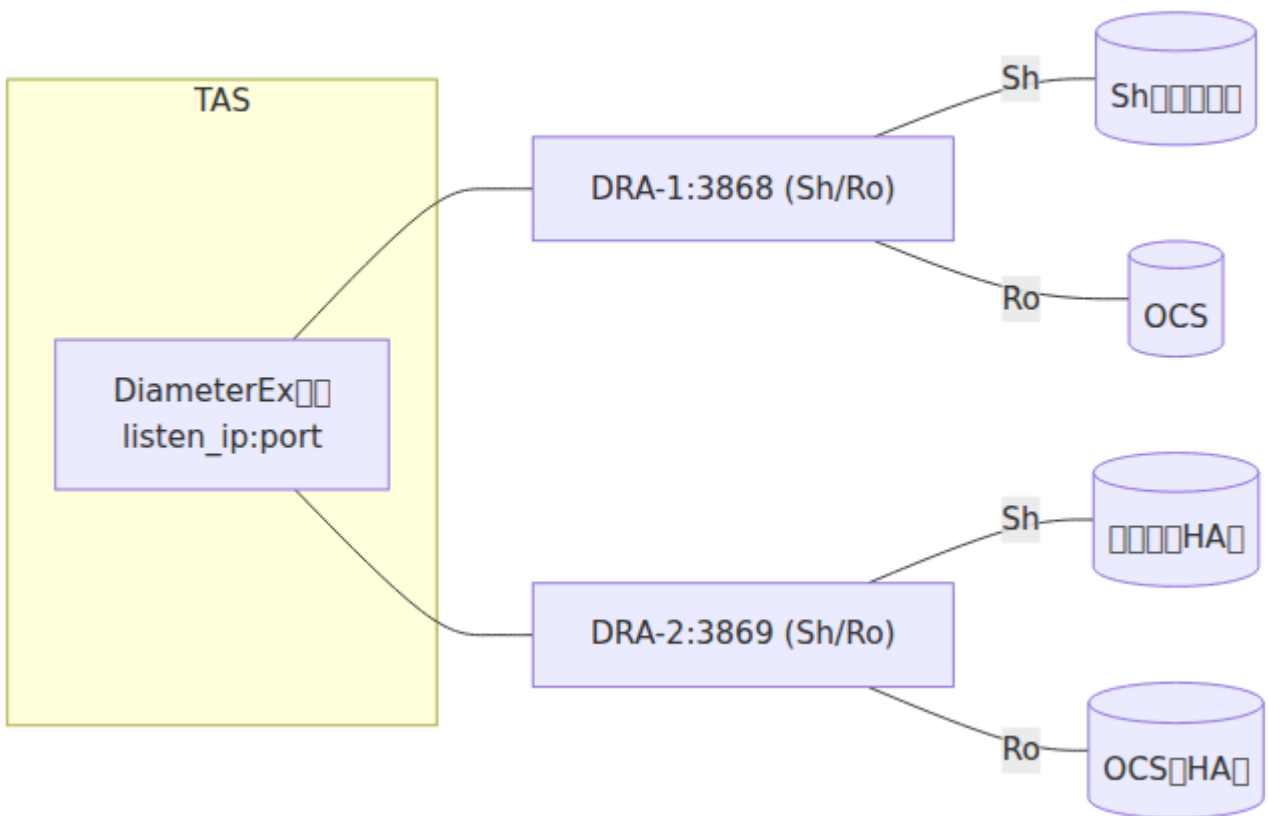

```

config :diameter_ex,
  diameter: %{
    service_name: :omnitouch_tas,
    listen_ip: "10.8.82.60",
    listen_port: 3868,
    decode_format: :map,
    host: "example-dc01-as01",
    realm: "epc.mnc001.mcc001.3gppnetwork.org",
    product_name: "OmniTAS",
    request_timeout: 5000,
    peer_selection_algorithm: :random,
    allow_undefined_peers_to_connect: true,
    log_unauthorized_peer_connection_attempts: true,
    control_module: Tas.Control.Diameter,
    processor_module: DiameterEx.Processor,
    auth_application_ids: [],
    acct_application_ids: [],
    vendor_id: 10415,
    supported_vendor_ids: [10415],
    # destination_realm
    # destination_realm: "global.destination.realm",
    applications: [
      %{
        application_name: :sh,
        application_dictionary: :diameter_gen_3gpp_sh,
        # destination_realm
        # destination_realm: "sh.destination.realm",
        vendor_specific_application_ids: [
          %{
            vendor_id: 10415,
            auth_application_id: 16_777_217,
            acct_application_id: nil
          }
        ]
      },
      %{
        application_name: :ro,
        application_dictionary: :diameter_gen_3gpp_ro,
        # destination_realm
        # destination_realm: "ocs.destination.realm",
        vendor_specific_application_ids: [
          %{
            vendor_id: 0,

```

```

        auth_application_id: 4,
        acct_application_id: nil
    }
  ]
}
],
peers: [
  %{
    port: 3868,
    host: "example-dc01-
dra01.epc.mnc001.mcc001.3gppnetwork.org",
    ip: "1.2.3.4",
    realm: "epc.mnc001.mcc001.3gppnetwork.org",
    tls: false,
    transport: :diameter_tcp,
    initiate_connection: true
  },
  %{
    port: 3869,
    host: "example-dc01-
dra02.epc.mnc001.mcc001.3gppnetwork.org",
    ip: "1.2.3.44",
    realm: "epc.mnc001.mcc001.3gppnetwork.org",
    tls: false,
    transport: :diameter_tcp,
    initiate_connection: true
  }
]
}

```

Diameter

- **service_name** ([]) Diameter
- :omnitouch_tas
-
- **listen_ip** ([]) Diameter IP

- `"10.8.82.60"`
- `"0.0.0.0"`   `0.0.0.0`
- `0.0.0.0` IP
- **listen_port** (int) Diameter TCP
 - Diameter `3868`
 - `0.0.0.0`
- **host** (string) Diameter
 - `"example-dc01-as01"`
 - `realm` Origin-Host AVP
 - Diameter
- **realm** (string) Diameter
 - `"epc.mnc001.mcc001.3gppnetwork.org"`
 - Origin-Realm AVP
 - 3GPP
- **product_name** (string) CER/CEA
 - `"OmniTAS"`
 -
- **request_timeout** (int) Diameter
 - `5000` 5
 -
- **peer_selection_algorithm** (string)
 - `:random` | `:round_robin` | `:priority`
 - `:random`
 - `:round_robin`
- **vendor_id** (int) 3GPP ID
 - 3GPP ID `10415`

```

# 1
config :diameter_ex,
  diameter: %{
    realm: "epc.mnc001.mcc001.3gppnetwork.org",
    applications: [
      %{
        application_name: :sh,
        destination_realm:
"oss.epc.mnc001.mcc001.3gppnetwork.org",
        # ...
      },
      %{
        application_name: :ro,
        destination_realm:
"ocs.epc.mnc001.mcc001.3gppnetwork.org",
        # ...
      }
    ]
  }

# 2
config :diameter_ex,
  diameter: %{
    realm: "epc.mnc001.mcc001.3gppnetwork.org",
    destination_realm: "dra.epc.mnc001.mcc001.3gppnetwork.org", #
applications: [
  %{
    application_name: :sh,
    # "dra.epc.mnc001.mcc001.3gppnetwork.org"
  },
  %{
    application_name: :ro,
    destination_realm:
"ocs.epc.mnc001.mcc001.3gppnetwork.org", #
  }
]
}

# 3
config :diameter_ex,
  diameter: %{
    realm: "epc.mnc001.mcc001.3gppnetwork.org",

```

```
#
applications: [
  %{
    application_name: :sh,
    # "epc.mnc001.mcc001.3gppnetwork.org"
  }
]
```

- Sh HSS Ro OCS
- **DRA** DRA Destination-Realm
-
-

```
destination_realm
  ↓
destination_realm
  ↓
realm
```

Destination-Realm AVP

Web UI _Diameter_ Diameter

Web UI_Sh_Sh_Sh

目录

快速入门

XML 配置

部署

安装

- [快速入门 README](#) - 快速入门
- [部署](#) - SIP 配置
- [安装](#) - 安装指南

配置

- [部署](#) - E.164 号码
- [Sh 配置](#) - 配置指南
- [SS7 MAP](#) - 配置 MSRN/HLR
- [部署](#) - 配置 OCS

工具

- [CLI 工具](#) - 配置 CLI
- [部署](#) - 部署指南
- [TTS 工具](#) - 配置 TTS

附录

- [部署](#) - 部署指南
 - [部署](#) - 部署指南
-

XML / TAS

TAS XML TAS XML TAS SS7 IMPI / IMPU

priv/templates

- mo_dialplan.xml -
- mo_emergency_dialplan.xml -
- mt_dialplan.xml -

Web UI

XML TAS

□□□□□

INVITE

OmniCharge

OmniRAN

Downloads

☒ □□□□ ▼

OmniTouch Website [↗](#)

MO

MT

□□

mo_dialplan.xml

mt_dialplan.xml

mo_emergency_dialplan.xml

□□□□,
XML □□□□

□□□ B-□□,
□□ Sh/□□□ CF □□

□□□ PSAP/GW

Ro □□?
□□□□□□□□?

yes

no

CCR-I/CCR-U/CCR-T

□□□ On-Net/SBC/Trunk
(msrn □□□□□)

□□□□/□□?

yes

no

□□□□ / □□□□□□

200 OK / BYE

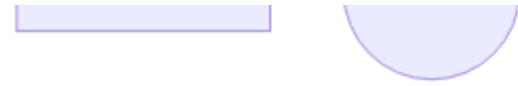

FreeSWITCH XML

OmniTAS FreeSWITCH XML

```
<extension name="description-of-what-this-does">
  <condition field="{variable}" expression="regex-pattern">
    <action application="app_name" data="parameters"/>
    <anti-action application="app_name" data="parameters"/>
  </condition>
</extension>
```

```
<condition field="{tas_destination_number}" expression="2222">
  <action application="log" data="INFO "/>
</condition>
```

```
<condition field="{tas_destination_number}"
expression="^(2222|3444|3445)$">
  <action application="log" data="INFO "/>
</condition>
```

XXXXXXXXXX

```
<condition field="{tas_destination_number}" expression="^1(8[0-9]{9})$">  
  <!-- 1 8 9  -->  
  <action application="log" data="INFO XXXXXX: $1"/>  
  <action application="bridge"  
data="sofia/gateway/trunk/{tas_destination_number}"/>  
</condition>
```

XXXX

```
<condition field="{tas_destination_number}" expression="^00">  
  <!-- 00  -->  
  <action application="log" data="INFO XXXXXX"/>  
</condition>
```

XXXX

```
<condition field="{msisdn}" expression="^5551241[0-9]{4}$">  
  <!-- 55512410000 55512419999  -->  
  <action application="log" data="INFO XXXXXX"/>  
</condition>
```

XXXXXXXX

XX XXXXXXXXXXXXXXXXXXXX XXXXXXXXXXXX

```

<condition field="{cli_withheld}" expression="true">
  <!-- CLI  -->
  <action application="set"
data="effective_caller_id_number=anonymous"/>
  <action application="set"
data="origination_privacy=hide_number"/>

  <!-- CLI NOT  -->
  <anti-action application="log" data="DEBUG CLI  "/>
  <anti-action application="set"
data="effective_caller_id_number={msisdn}"/>
</condition>

```

continue="true"

continue="true"

continue

```

<extension name="First-Check">
  <condition field="{tas_destination_number}"
expression="^(.*)$">
  <action application="log" data="INFO  "/>
  </condition>
</extension>

<extension name="Never-Reached">
  <!--  -->
  <condition field="{tas_destination_number}"
expression="^(.*)$">
  <action application="log" data="INFO  "/>
  </condition>
</extension>

```

continue="true":

```

<extension name="Print-Vars" continue="true">
  <condition field="{tas_destination_number}"
expression="^(.*)$">
    <action application="info" data=""/>
  </condition>
</extension>

<extension name="Check-Balance" continue="true">
  <condition field="{hangup_case}"
expression="OUTGOING_CALL_BARRED">
    <action application="log" data="ERROR [][] []"/>
    <action application="hangup" data="{hangup_case}"/>
  </condition>
</extension>

<extension name="Route-Call">
  <!-- [] [] [] [] [] [] [] [] -->
  <condition field="{tas_destination_number}"
expression="^(.*)$">
    <action application="bridge"
data="sofia/gateway/trunk/{tas_destination_number}"/>
  </condition>
</extension>

```

continue="true" [] [] []

- [] [] [] [] / [] [] [] []
- [] [] [] [] [] [] [] [] [] [] [] [] [] []
- [] [] [] [] [] [] [] [] [] []

[] [] [] []

[] [] [] []

answer - [] [] [] [] [] [] 200 OK []

```

<action application="answer" data=""/>

```

hangup - [] [] [] [] [] [] [] [] [] []

```
<action application="hangup" data="NORMAL_CLEARING"/>
<action application="hangup" data="USER_BUSY"/>
<action application="hangup" data="NO_ANSWER"/>
```

bridge - 橋をかける

```
<!-- 橋をかける -->
<action application="bridge"
data="sofia/gateway/trunk/+12125551234"/>

<!-- 橋をかける際のコーデック -->
<action application="bridge" data="{absolute_codec_string=AMR-
WB,AMR,PCMA}sofia/internal/sip:user@domain.com"/>

<!-- 橋をかける際のタイムアウト -->
<action application="bridge" data="{originate_timeout=30}sofia/gateway/trunk/${tas_destination_number}"/>
```

橋をかける

set - 変数を設定する

```
<action application="set" data="my_variable=my_value"/>
<action application="set" data="sip_h_X-Custom-
Header=CustomValue"/>
<action application="set"
data="effective_caller_id_number=anonymous"/>
```

unset - 変数を削除する

```
<action application="unset" data="sip_h_P-Asserted-Identity"/>
```

export - 変数を外部に公開する (B-leg)

```
<action application="export" data="sip_h_X-Account-Code=ABC123"/>
```

公開する

playback - 音声を再生

```
<action application="playback"  
data="/sounds/en/us/callie/misc/8000/out_of_credit.wav"/>  
<action application="playback"  
data="${base_dir}/sounds/custom_prompt.wav"/>
```

sleep - 一定時間待機

```
<action application="sleep" data="1000"/> <!-- 1 秒待機 -->
```

echo - 入力された音声をそのまま再生

```
<action application="echo" data=""/>
```

conference - 会議に参加

```
<action application="conference"  
data="room-${destination_number}@wideband"/>
```

音声を再生

voicemail - 音声メッセージを再生

```
<!-- 音声メッセージを再生 -->  
<action application="voicemail" data="default default ${msisdn}"/>  
  
<!-- 音声メッセージを確認 -->  
<action application="voicemail" data="check auth default default  
${msisdn}"/>
```

音声メッセージを確認

log - ログを出力

```
<action application="log" data="INFO [][] [][] ${msisdn} [][]"/>
<action application="log" data="DEBUG [][]:
${tas_destination_number}"/>
<action application="log" data="ERROR [][] [][]: ${hangup_cause}"/>
```

info - [][] [][] [][] [][] [][]

```
<action application="info" data=""/>
```

[] [] [] []

say - [][] [][] [][] [][] [][]

```
<action application="say" data="en number iterated
${tas_destination_number}"/>
```

send_dtmf - [] [] DTMF [] []

```
<action application="send_dtmf" data="1234#"/>
```

[] [] [] []

[] [] [] [] [] [] [] []

```
<extension name="Emergency-911">
  <condition field="${tas_destination_number}"
expression="^(911|112)$">
    <action application="log" data="ALERT [] [] ${msisdn} [] [] [] []"/>
    <action application="answer" data=""/>
    <action application="playback"
data="/sounds/emergency_services_transfer.wav"/>
    <action application="bridge"
data="sofia/gateway/emergency_gw/${tas_destination_number}"/>
  </condition>
</extension>
```

□□□□□□□□□□

```
<extension name="Check-Credit">
  <condition field="{hangup_case}"
expression="OUTGOING_CALL_BARRED">
  <action application="answer" data=""/>
  <action application="playback"
data="/sounds/out_of_credit.wav"/>
  <action application="hangup" data="CALL_REJECTED"/>
</condition>
</extension>
```

On-Net □ **Off-Net** □□□

```
<extension name="Route-Decision">
  <condition field="{on_net_status}" expression="true">
    <!-- On-net: □□ TAS □□ -->
    <action application="log" data="INFO □□□ on-net □□□"/>
    <action application="bridge"
data="sofia/internal/+$tas_destination_number@10.179.3.60"/>
    <anti-action application="log" data="INFO □□□ off-net"/>
    <anti-action application="bridge"
data="sofia/gateway/trunk/+$tas_destination_number"/>
  </condition>
</extension>
```

□□□□□ **ID** □□□

```
<extension name="CLI-Privacy" continue="true">
  <condition field="{cli_withheld}" expression="true">
    <action application="set"
data="effective_caller_id_name=anonymous"/>
    <action application="set"
data="effective_caller_id_number=anonymous"/>
    <action application="set"
data="origination_privacy=hide_number"/>
  </condition>
</extension>
```

□□□□□□□□□□

```
<extension name="Try-Bridge-Then-VM">
  <condition field="{tas_destination_number}"
expression="^(555124115\d{2})$" >
  <action application="set" data="call_timeout=30"/>
  <action application="bridge"
data="sofia/internal/{tas_destination_number}@domain.com"/>

  <!-- □□□□□□□□□□□□□□ -->
  <action application="log" data="INFO □□□□□□□□□□"/>
  <action application="answer" data=""/>
  <action application="voicemail" data="default default
{tas_destination_number}"/>
</condition>
</extension>
```

□□□□□□□□

```

<extension name="Local-Numbers">
  <condition field="{tas_destination_number}" expression="^([2-9]\d{2})$">
    <!-- 3 200-999 -->
    <action application="log" data="INFO : $1"/>
    <action application="bridge"
data="sofia/internal/$1@pbx.local"/>
  </condition>
</extension>

<extension name="National-Numbers">
  <condition field="{tas_destination_number}"
expression="^555\d{7}$">
    <!-- -->
    <action application="log" data="INFO "/>
    <action application="bridge"
data="sofia/gateway/national_trunk/{tas_destination_number}"/>
  </condition>
</extension>

<extension name="International">
  <condition field="{tas_destination_number}"
expression="^00\d+$">
    <!-- 00 -->
    <action application="log" data="INFO "/>
    <action application="bridge"
data="sofia/gateway/intl_trunk/{tas_destination_number}"/>
  </condition>
</extension>

```

□□□□□

□□□□□□□□□□□□□□□□

- **FreeSWITCH** □□□□□□□□
<https://freeswitch.org/confluence/display/FREESWITCH/Dialplan>
- **FreeSWITCH mod_dptools**□
https://freeswitch.org/confluence/display/FREESWITCH/mod_dptools (□□□□□□□□□□)
- □□□□□□□□□□
<https://freeswitch.org/confluence/display/FREESWITCH/Regular+Expression>

- 参考

<https://freeswitch.org/confluence/display/FREESWITCH/Channel+Variables>

FreeSWITCH wiki 参考

参考

TAS の XML 参考

参考

参考

- `destination_number` - 宛先番号
- `tas_destination_number` - TAS 宛先番号
- `effective_caller_id_number` - 有効発信番号

参考

- `hangup_case` - "none"
- `ims_private_identity` - IMS プライベートアイデンティティ
- `ims_public_identity` - IMS パブリックアイデンティティ
- `msisdn` - MSISDN +
- `imsi` - IMSI
- `ims_domain` - IMS ドメイン

MT 参考

- `ims_private_identity` - IMS プライベートアイデンティティ
- `ims_public_identity` - IMS パブリックアイデンティティ
- `msisdn` - MSISDN +
- `imsi` - IMSI
- `ims_domain` - IMS ドメイン
- `call_forward_all_destination` - CFA 宛先 "none"
- `call_forward_not_reachable_destination` - CFNRc 宛先
- `scscf_address` - S-CSCF 宛先 "none"
- `scscf_domain` - S-CSCF ドメイン "none"

- `no_reply_timer` - 000000
- `hangup_case` - "none" 0 "UNALLOCATED_NUMBER"
- `msrn` - 00 PRN 0 MSRN0000000000 SRI 0000000000000000
- `tas_destination_number` - 000000000000 MSRN 0000000

MO 0000000000

- `hangup_case` - "none", "OUTGOING_CALL_BARRED", 0 "UNALLOCATED_NUMBER"
- `ims_private_identity` - 00000000
- `ims_public_identity` - 00000000
- `msisdn` - 0000000000 +0
- `imsi` - 00000000 IMSI
- `ims_domain` - 0000000000
- `allocated_time` - OCS 0000000000000000
- `cli_withheld` - "true" 0 "false" 0000
- `on_net_status` - "true" 0 "false" 0000000000000000
- `msrn` - 00000000 MSRN00000000
- `tas_destination_number` - MSRN 0000000000

000000

00000000 `emergency_call_codes` 00000000000000000000000000

00

0000 TAS 00000000000000000000

000000

- `emergency_call_codes`: 00000000000000
- 0000: "911"000000"112"000000"000"000000000"999"000000"sos"
- 000000 SIP 00 URN000000 <urn:service:sos>0000000000
- 0000000000000000 0000 00

00000000

??????

```
<extension name="Emergency-SOS">
  <condition field="{destination_number}"
expression="^(911|912|913|sos)$">
  <action application="log" data="ALERT {} {msisdn} {}"/>
  <action application="answer" data=""/>
  <action application="bridge"
data="sofia/gateway/psap_gw/{destination_number}"/>
  </condition>
</extension>
```

????

- ???? "sos" ?????????????? SIP URN
- ?????????????????????911?112?000?999?
- ????????? ????????
- ?? **OCS** ?????????????? `skipped_regex` ???
- ?? **PSAP** ?? ??????????????
- ?????????? ??????????

IVR ??

IVR ?????????????????? DTMF ?????????????????? XML ?????????????????? `ivr` ??????????

?? **IVR** ??

1. ? `hosts/<environment>/group_vars/ivr_menus/` ??? XML ???

```

<include>
  <menu name="my_menu"
    greet-
long="`${base_dir}/sounds/en/us/callie/misc/8000/my_greeting.wav"
    greet-
short="`${base_dir}/sounds/en/us/callie/misc/8000/my_greeting.wav"
    invalid-sound="silence_stream://250"
    exit-sound=""
    timeout="5000"
    max-failures="1"
    max-timeouts="1"
    digit-len="1">

    <!-- ████████████████████ -->
    <entry action="menu-exec-app" digits="1" param="playback
`${base_dir}/sounds/option1.wav"/>
    <entry action="menu-exec-app" digits="1" param="bridge
sofia/internal/100@`${domain}"/>

    <entry action="menu-exec-app" digits="2" param="playback
`${base_dir}/sounds/option2.wav"/>
    <entry action="menu-exec-app" digits="2" param="bridge
sofia/internal/200@`${domain}"/>

    <!-- ████████████████ -->
    <entry action="menu-exec-app" digits="timeout" param="bridge
sofia/internal/default@`${domain}"/>
    <entry action="menu-exec-app" digits="invalid" param="bridge
sofia/internal/default@`${domain}"/>
  </menu>
</include>

```

2. ████████████████████

```

<extension name="my_ivr_extension">
  <condition field="destination_number" expression="^1234$">
    <action application="answer"/>
    <action application="ivr" data="my_menu"/>
  </condition>
</extension>

```

3. Ansible

Ansible

Option	Description
<code>name</code>	Default value: <code>ivr</code>
<code>greet-long</code>	
<code>greet-short</code>	
<code>timeout</code>	
<code>max-failures</code>	Default value: <code>invalid</code>
<code>max-timeouts</code>	Default value: <code>timeout</code>
<code>digit-len</code>	

Ansible

Ansible `action="menu-exec-app"`

Option	Description
<code>digits="1"</code>	
<code>digits="timeout"</code>	
<code>digits="invalid"</code>	

Ansible `playback` `bridge` `transfer` `hangup`

On-Net 呼叫計劃 On-Net 呼叫計劃

MO 呼叫計劃 TAS 與 MT 呼叫計劃 MSRN 呼叫計劃

MO 與 MT

MT 呼叫計劃

- 呼叫計劃
- 呼叫計劃
- 呼叫計劃 MSRN
- 呼叫計劃

MT 呼叫計劃 TAS

- 呼叫計劃 CFU, CFB, CFNRy, CFNRc
- 呼叫計劃
- CS 呼叫計劃 MSRN
- 呼叫計劃
- 呼叫計劃

MO

MO 呼叫計劃 TAS 呼叫計劃 TAS 呼叫計劃 MT 呼叫計劃
mt_dialplan.xml 呼叫計劃

呼叫計劃

```

<extension name="On-Net-Route">
  <condition field="{on_net_status}" expression="true">
    <action application="log" data="DEBUG On-Net MO [ ] - [ ] TAS" />

    <!-- [ ] [ ] [ ] [ ] [ ] [ ] [ ] [ ] [ ] [ ] -->
    <action application="set" data="sip_copy_multipart=false"/>
    <action application="set" data="sip_h_Request-Disposition=no-fork

    <!-- [ ] [ ] TAS [ ] [ ] MT [ ] [ ] -->
    <action application="bridge"
      data="{absolute_codec_string='AMR-
WB,AMR,PCMA,PCMU',originate_retries=1,originate_timeout=60,sip_invite
/>
    <action application="hangup" data="" />
  </condition>
</extension>

```

[] [] [] []

- `{sip_local_network_addr}` - TAS IP [] [] [] [] [] [] [] [] [] [] 10.179.3.60 []
- `{tas_destination_number}` - [] [] [] MSISDN
- `sip_invite_call_id={sip_call_id}` - [] [] [] ID [] [] []
- `sip_copy_multipart=false` - [] [] [] [] [] [] [] [] []
- `sip_h_Request-Disposition=no-fork` - [] [] [] [] [] []

[] [] [] []

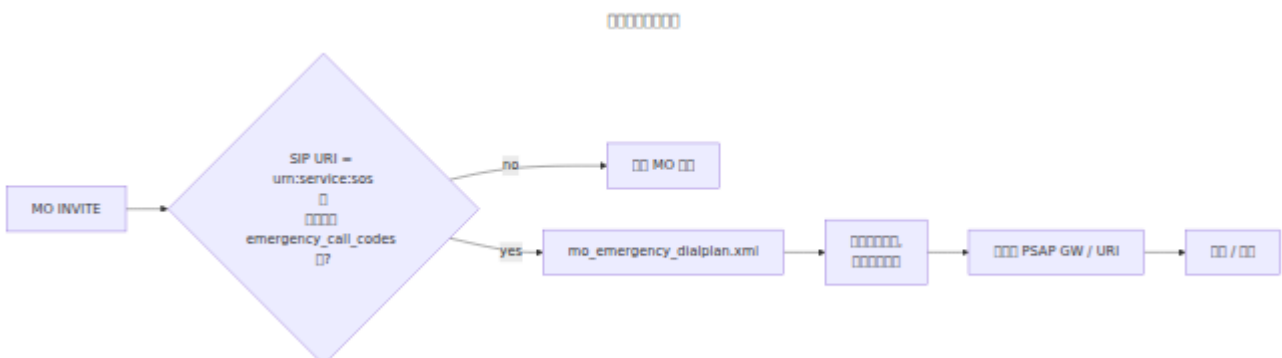

[] [] [] []

- TAS IP [] [] [] [] [] [] [] [] [] [] allowed_sbc_source_ips [] [] [] []
- [] [] TAS [] [] [] [] [] [] [] [] [] [] MT [] []

- TAS 2G/3G CS MSRN
-

MSRN 2G/3G

2G/3G CS TAS MSRN MSRN

MSRN

MSRN VLR CS

MSRN

TAS SS7 MAP MSRN

□□□□□□ MT □□□ MSRN □□

MT □□□□□□

□□□□□□ (SRI)

SRI □□□□□□

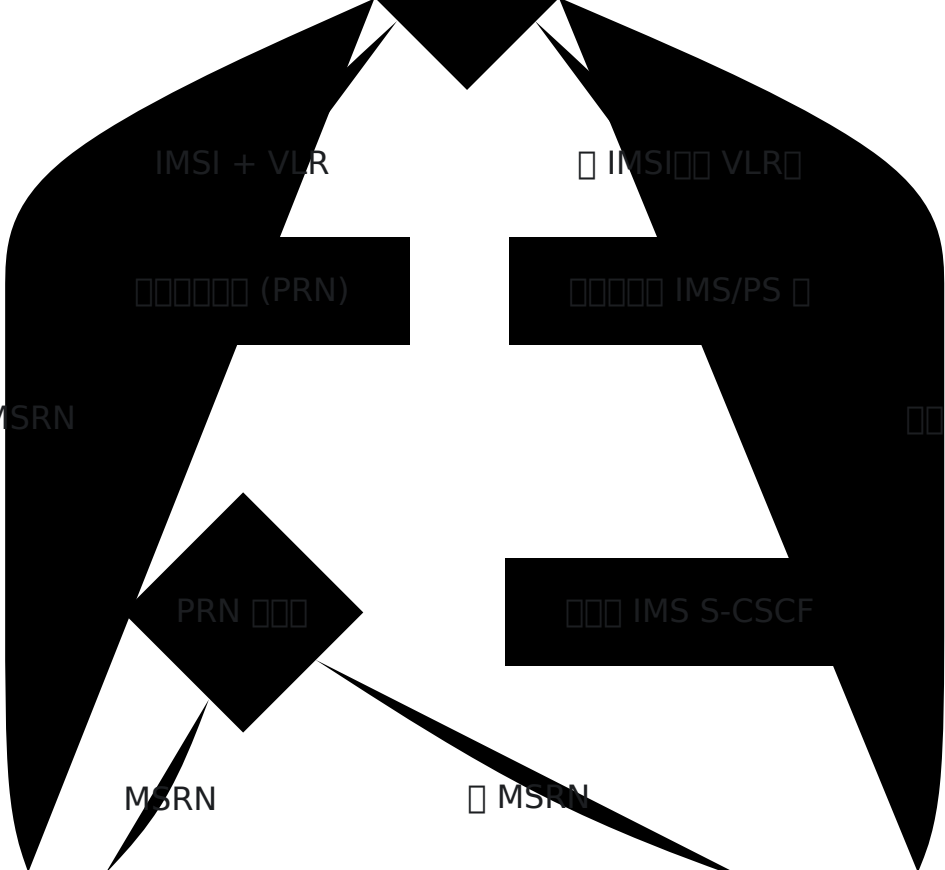

IMSI + VLR

IMS/PS

□□□□□□ (PRN)

IMS S-CSCF

□□ MSRN

□□□□

PRN □□□□

MSRN

□ MSRN

□□ SRI □□ MSRN

□□□□□□□□

□□□□□□□□: msn

□□□□□□□□

CS ???? MSRN

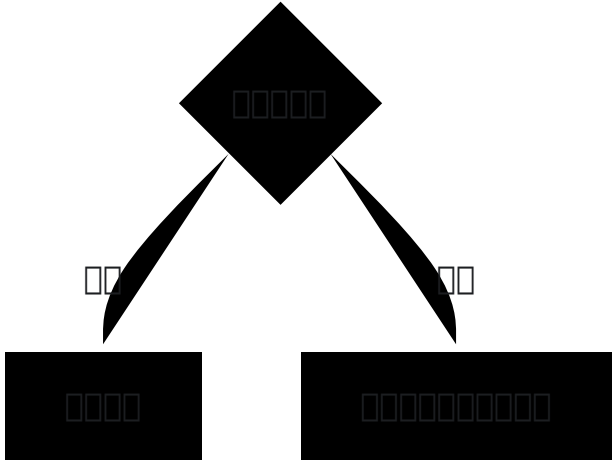

CS

SRI

TAS CS SS7 MAP CS HLR

SRI

1. **SRI** CS **MSRN** - CS MSRN CS
 - o CS MSISDN GMSC IMSI CS MSRN
 - o CS MSRN: 61412345678 CS
2. **IMSI + VLR** CS - CS CS PRN
 - o CS MSISDN GMSC IMSI CS MSC/VLR CS
 - o CS CS MSRN
3. **IMSI** CS **VLR** - CS CS IMS/PS
 - o CS MSISDN GMSC IMSI
 - o CS IMS/4G CS CS
4. CS - SRI CS

- 00000000000000000000000000000000
- 0000000000

0000000000 (**PRN**) - 0000

00 SRI 00 IMSI + VLR 000 MSRN 0TAS 00 VLR 00 PRN 00000 MSRN0

VLR 0000000000 MSRN0000000000 TAS00 MSRN 0000000000000000

00 **PRN** 000 MSRN 61412345678

000000000 **msrn**

0000 SS7 MAP 000 MSRN0000000000000000000000 MT 0000000000

0000 `${msrn}`

- 000 0000E.164 0000000 +0
- 000 "61412345678" 000000000000
- 000 0000000 CS 000000
- 00 0 MT 00000000 HLR 0000000000

0 **mt_dialplan.xml** 00000 **MSRN**

MSRN 000 MT 000000000000000000000000000000000000

000000000

1. 00 **MSRN**000000 `msrn` 000000000000000000
2. 000000000
 - 0000000000000000 10 0
 - 000000000000000000000000000000000000
3. 000 **MSRN**0000 CS 0000000000 MSRN
 - 00 `ignore_early_media=ring_ready` 0000000000
 - 0000000000AMR0000000000PCMA/PCMU000000
 - 000 `sofia/gateway/CS_Gateway/+${msrn}`
4. 000000000000000000000000000000000000

XXXXXXXXXX

```
<extension name="Route-to-CS-MSRN" continue="false">
  <condition field="msrn" expression="^\d+$">
    <!-- XXXX -->
    <action application="set" data="progress_timeout=10" />
    <action application="set" data="bridge_answer_timeout=${no_reply_

    <!-- XX CS XXXXXX MSRN -->
    <action application="bridge"
      data="
{ignore_early_media=ring_ready,absolute_codec_string='AMR,PCMA,PCMU',
/>

    <!-- XXXXXXXXXXXXXXX/XXXX -->
    <action application="bridge"
      data="sofia/internal/${call_forward_not_reachable_destination}@
    </condition>
  </extension>
```

XXX

1. **MSRN** XXXX - XXXXXXXXXXXXX
2. XX **CS** XX - MSRN XX 2G/3G XXXXXXXX VoLTE/IMS XX
3. **MT** XXXXXXXX - MSRN XXXXXXXX IMS XXXX
4. XXXXXX - XX MSRN XXXXXXXXXXXXXXXXXXXX
5. **HLR** XXX **Sh** - HLR XX MSRN XXX Sh XXXXX

XX

XXX TAS XXXXX SS7 MAP XXX

XXXXXX

- **enabled:** XXX true XXX SS7 MAP XX
- **http_map_server_url_base:** XXXX SS7 MAP XXX URLXX
XX "http://10.1.1.100:5001" XX
- **gmsc:** SRI/PRN XXXXX MSC XXXXXXX "61400000000" XX

- **timeout_ms:** 5000

SS7 MAP

SS7 MAP

TAS Sh HSS SS7 MAP
HLR HLR

SS7 MAP

SS7 MAP

SS7 MAP	SS7 MAP	SS7 MAP
CFU	call_forward_all_destination	
CFB	call_forward_not_reachable_destination	
CFNRy	call_forward_not_reachable_destination	
CFNRc	call_forward_not_reachable_destination	

SS7 MAP

1. Sh (HSS)

SS7 MAP HSS

TAS Sh HSS

SS7 MAP

- `call_forward_all_destination`: CFU `"61412345678"`
- `call_forward_not_reachable_destination`: CFB/CFNRy/CFNRc `"61487654321"`
- `no_reply_timer`: CFNRy `"20"`

2. SS7 MAP (HLR)

HLR HSS USSD/MMI *21*

TAS SS7 MAP HLR

HLR

- **forwarded_to_number**: `"61412345678"`
- **reason**:
- **notification flags**:

- `call_forward_all_destination`
- `call_forward_not_reachable_destination`

HLR Sh

TAS MT

1. Sh HSS
2. SS7 MAP HLR
3. HLR Sh

USSD HSS

MT

名前	タイプ	値	説明
<code>call_forward_all_destination</code>	整数	"61412345678"	CFU 宛先番号
<code>call_forward_not_reachable_destination</code>	整数	"61487654321"	CFB/CFN 宛先番号
<code>no_reply_timer</code>	整数	"20"	CFNRy タイマー

設定

- `call_forward_all_destination` "none" に設定
- `call_forward_not_reachable_destination` `^(?!none$).*` に設定 "none"

mt_dialplan.xml の設定

1. CFU (Call Forwarding Unconditional)

以下は、CFU の設定例です。

以下は、`sofia/gateway/ExternalSIPGateway` に PSTN 宛先を設定する例です。

設定

```

<extension name="Check-Call-Forward-All">
  <condition field="${call_forward_all_destination}" expression="^(?!
    <action application="log" data="INFO [0000000000000000] ${call_forward

    <!-- [00000000] History-Info [ ] -->
    <action application="set" data="sip_h_History-Info=<sip:${destina

    <!-- [0000] ID [0000000000] -->
    <action application="set" data="sip_call_id=${sip_call_id};CALL_F

    <!-- [0000000000] -->
    <action application="bridge"
      data="{absolute_codec_string='AMR-
WB,AMR,PCMA,PCMU',originate_retries=1,originate_timeout=60}sofia/gate
/>
  </condition>
</extension>

```

0000

- 00000000000000000000000000000000
- ;CALL_FORWARD_UNCONDITIONAL 0000 ID 0000
- History-Info 000000000000
- 000000 61412345678 CFU 61487654321 - 00000000

00 20000/00000000

0000000000000000000000000000000000

0000000000

```

<!-- MSRN  IMS ... -->
<action application="log" data="INFO MSRN - MSRN" />

<!-- History-Info ... -->
<action application="set" data="sip_h_History-Info=<sip:${destination}

<!-- ... -->
<action application="bridge"
  data="
{absolute_codec_string='AMR,PCMU,PCMA',originate_timeout=65}sofia/gat
/>

```

MSRN

- MSRN 61412345678 CFNRy MSRN 61487654321
- MSRN
- 20 MSRN no_reply_timer
- MSRN 61487654321 MSRN History-Info

History-Info

History-Info SIP

```

<action application="set" data="sip_h_History-Info=
<sip:${destination_number}@${ims_domain}>;index=1.1" />

```

MSRN

- MSRN \${destination_number}
- MSRN
- MSRN

MSRN

```

<extension name="Voicemail Route" continue="false">
  <condition field="{tas_destination_number}"
expression="^(555121|555122)$">
  <!-- History Info -->
  <action application="set"
data="history_info_value={sip_i_history_info}"/>
  <action application="log" data="DEBUG {history_info_value}" />

  <!-- -->
  <action application="voicemail" data="default default
{history_info_value}"/>
</condition>
</extension>

```

注意

- 555121 555122
- History-Info
- History-Info
-

注意

1. none - ^(?!(none\$)).* none
2. History-Info -
3. continue_on_fail -
4. CLI - ID
5. -

ID (CLI)

TAS CLI

CLI 設定

設定項目の CLI 設定

項目	説明	設定値
<code>msisdn</code>	電話番号 +	"61412345678"
<code>effective_caller_id_number</code>	発信元番号	"+61412345678" 〇 "anonymous"
<code>effective_caller_id_name</code>	発信元名前	"+61412345678" 〇 "anonymous"
<code>origination_caller_id_number</code>	発信元 CLI	"+61412345678"
<code>caller_id_number</code>	FreeSWITCH CLI 発信元番号	"+61412345678"
<code>sip_from_user</code>	SIP From 発信元 発信元	"0412345678" 〇 "+61412345678"
<code>cli_withheld</code>	発信元番号隠し	"true" 〇 "false" 〇〇〇 〇〇
<code>origination_privacy</code>	発信元プライバシー	"hide_number"

CLI 設定/設定

設定

TAS 設定項目の CLI 設定

1. 設定項目

設定項目の ID

設定

- *67 - 匿名
- #31# - GSM 匿名
- 1831 - 匿名

TAS 匿名 CLI cli_withheld "true"

*67555 1234 - *67 5551234 CLI

2. From 匿名

UE SIP From "anonymous"

TAS Caller-Orig-Caller-ID-Name "anonymous" cli_withheld "true"

3. SIP 匿名

S-CSCF SIP INVITE Privacy: id

cli_withheld CLI

```

<extension name="Outgoing-Call-CLI-National" continue="true">
  <condition field="{msisdn}" expression="^61(.*)$">
    <action application="log" data="□□□□□□ CLI □ $1" />
    <action application="set"
data="effective_caller_id_number=$1"/> <!-- 0412345678 -->
    <action application="set" data="effective_caller_id_name=$1"/>
    <action application="set" data="sip_from_user=$1"/>
    <action application="set" data="sip_cid_type=pid"/>
  </condition>
</extension>

```

□□□□□

- □□□□□ ^61(.*)\$ □□□□□□ □ 61 □□□□□□□□
- □□□□ msisdn="61412345678" → □□□□ \$1="412345678" □ "0412345678"
- □□□□□□□□□□□□□□□□ CLI

□□□□□□□□

□□□□□□□□□□□□□□□□ E.164 □□□□□□ CLI□□□□ + □□□□

□□□□□□□□□□

```

<extension name="Outgoing-Call-CLI-International" continue="true">
  <condition field="{tas_destination_number}"
expression="^61(.*)$">
    <action application="log" data="□□□□□□□□" />

    <!-- □□□□□□□□□□□□□□□□□□□□ -->
    <anti-action application="log" data="□□□□□□□□ CLI" />
    <anti-action application="set"
data="effective_caller_id_number=+${msisdn}"/> <!-- +61412345678
-->
    <anti-action application="set"
data="effective_caller_id_name=+${msisdn}"/>
    <anti-action application="set"
data="sip_from_user=+${msisdn}"/>
    <anti-action application="set" data="sip_cid_type=pid"/>
  </condition>
</extension>

```

- SIP P-Asserted-Identity
- IMS ID
- IMS

Configuration

Configuration for SIP P-Asserted-Identity

Configuration for IMS ID

```
<action application="set" data="sip_copy_multipart=false"/>
<action application="set" data="sip_copy_custom_headers=false"/>
<action application="unset" data="sip_h_P-Internal-Correlation-ID"/>
<action application="unset" data="sip_h_P-Access-Network-Info"/>
<!-- Configuration -->
```

Steps

- Configuration
- Configuration
- Configuration
- SIP

Configuration

- ID
- Configuration
- P
- Configuration

CLI

1. CLI `continue="true"` - CLI
2. `sip_cid_type=pid` - IMS
3. CLI `*67` `#31#`

4. 設定 - CLI
5. 設定 -
6. 設定 - CLI

設定

TAS において FreeSWITCH の `bridge` アプリケーションを IMS と PSTN を接続するための設定を行います。

設定

設定 SIP と TAS の SIP を接続するための設定を行います。

設定

```
<gateway name="CS_Gateway">
  <param name="proxy" value="10.1.1.100:5060"/>
  <param name="register" value="false"/>
  <param name="caller-id-in-from" value="true"/>
  <param name="extension-in-contact" value="true"/>
</gateway>
```

設定 の設定

設定

設定

設定

```
<action application="bridge"
  data="sofia/gateway/GATEWAY_NAME/DESTINATION_NUMBER" />
```

設定

```
<action application="bridge" data="
{param1=value1,param2=value2}sofia/gateway/GATEWAY_NAME/DESTINATION_M
/>
```

GATEWAY_NAME IMS_Core PSTN_Primary
International_Gateway

absolute_codec_string -

```
<action application="bridge" data="
{absolute_codec_string='AMR,PCMA,PCMU'}sofia/gateway/IMS_Gateway/+$n
/>
```

1. **AMR** -
2. **PCMA** G.711 a-law -
3. **PCMU** G.711 μ-law -

priv/templates/mt_dialplan.xml:80 mo_dialplan.xml:124
mo_dialplan.xml:202

originate_timeout -

```
<action application="set" data="originate_timeout=60"/>
<action application="bridge" data="
{originate_timeout=60}sofia/gateway/CS_Gateway/+$msisdn" />
```

progress_timeout - 180/183

```
<action application="set" data="progress_timeout=10" />
```

bridge_answer_timeout - 000000000 200 OK 0000

```
<action application="set" data="bridge_answer_timeout=${no_reply_timer}" />
```

leg_progress_timeout - 0000000000

```
<action application="set" data="leg_progress_timeout=${no_reply_timer}" />
```

000000 priv/templates/mt_dialplan.xml:73-76

```
<action application="set" data="progress_timeout=10" />
<!-- 000 INVITE 0 200 OK 0000000000000000 -->
<action application="set" data="bridge_answer_timeout=${no_reply_timer}" />
<action application="set" data="leg_progress_timeout=${no_reply_timer}" />
```

000 \${no_reply_timer} 000000000000 20-30 00

00000000

originate_retries - 000000000

```
<action application="bridge" data="{originate_retries=1}sofia/gateway/CS_Gateway/${msisdn}" />
```

continue_on_fail - 0000000000000000

```
<action application="set" data="continue_on_fail=true" />
<action application="bridge" data="
{continue_on_fail=true}sofia/gateway/CS_Gateway/${msisdn}" />
<!-- 0000000000000000 -->
<action application="log" data="INFO 0000 - 00000000" />
```

hangup_after_bridge - B-leg 000000 A-leg

```
<action application="set" data="hangup_after_bridge=true"/>
```

000000

ignore_early_media - 0000000000

```
<action application="set" data="ignore_early_media=ring_ready" />
<action application="bridge" data="
{ignore_early_media=ring_ready}sofia/gateway/CS_Gateway/${msisdn}"
/>
```

000

- **ring_ready** - 0000000000000000
- **true** - 00000000
- **false** 0000 - 00000000000000

00000 **ring_ready** - 00000000000000000000

00000 **priv/templates/mt_dialplan.xml:78-79**

```
<action application="set" data="ignore_early_media=ring_ready" />
<action application="bridge" data="
{ignore_early_media=ring_ready,...}sofia/gateway/CS_Gateway/${msrn}"
/>
```

000000000000

```

<extension name="Route-to-IMS-Sub" continue="false">
  <condition field="destination_number" expression="^(.*)$">
    <action application="set" data="continue_on_fail=true" />
    <action application="set" data="hangup_after_bridge=true"/>
    <action application="set" data="progress_timeout=10" />

    <!-- INVITE 200 OK  -->
    <action application="set" data="bridge_answer_timeout=${no_reply_t
    <action application="set" data="leg_progress_timeout=${no_reply_t

    <!-- IMS S-CSCF  -->
    <action application="set" data="ignore_early_media=ring_ready" />
    <action application="set" data="sip_cid_type=pid" />

    <action application="bridge"
      data="{absolute_codec_string='AMR-
WB,AMR,PCMA,PCMU',ignore_early_media=ring_ready,continue_on_fail=true
/>

    <!--  -->
    <action application="log" data="INFO  -  " />
    <action application="set" data="sip_h_History-Info=<sip:${destina
    <action application="set" data="sip_h_Diversion=<sip:${destinatio

    <!--  -->
    <action application="bridge"
      data="{absolute_codec_string='AMR-WB,AMR,PCMU,PCMA',originate_t
    </condition>
  </extension>

```

□□□□

- □□□ `{msisdn}@{ims_domain}` □□□□
`5551234567@ims.mnc380.mcc313.3gppnetwork.org` □
- IMS □□□S-CSCF/I-CSCF□□□□□□□□□□
- `ignore_early_media=ring_ready` □□□□□□□
- □□□□□□□□□□□□□□□□
- □□ `History-Info` □ `Diversion` □□□□□□□□□□

□□ 2□□□□ **MSRN**□**CS** □□□□

CS

priv/templates/mt_dialplan.xml:67-80

```

<extension name="Route-to-CS-MSRN" continue="false">
  <condition field="msrn" expression="^\d+$">
    <action application="set" data="continue_on_fail=true" />
    <action application="set" data="hangup_after_bridge=true"/>
    <action application="set" data="progress_timeout=10" />
    <action application="set" data="bridge_answer_timeout=${no_reply_
    <action application="set" data="leg_progress_timeout=${no_reply_t

    <!-- MSRN -->
    <action application="set" data="ignore_early_media=ring_ready" />
    <action application="set" data="sip_cid_type=pid" />
    <action application="bridge"
      data="
{ignore_early_media=ring_ready,absolute_codec_string='AMR,PCMA,PCMU',
/>
  </condition>
</extension>

```

3 On-Net MO MT TAS

TAS MT MT

TAS On-net MT

-
-
- MSRN
-

MO TAS MT

```

<extension name="On-Net-Route">
  <condition field="{on_net_status}" expression="true">
    <action application="log" data="DEBUG On-Net M0 {} - {} TAS" />

    <!-- {} -->
    <action application="set" data="sip_copy_multipart=false"/>
    <action application="set" data="sip_h_Request-Disposition=no-fork

    <!-- {} TAS {} MT {} -->
    <action application="bridge"
      data="{absolute_codec_string='AMR-
WB,AMR,PCMA,PCMU',originate_retries=1,originate_timeout=60,sip_invite
/>
    <action application="hangup" data="" />
  </condition>
</extension>

```

{} {}

1. **MO** {} A {} B {}
2. {} **On-Net** {} TAS {} {} `{on_net_status}` {}
3. {} **TAS** {}
 - sofia/internal/{tas_destination_number}@{sip_local_network_addr}
 - {} TAS {} IP {}
 - {} ID {}
4. **MT** {} TAS {} {} MT {} `mt_dialplan.xml`
 - {} CFU {} CFB {} CFNRy {} CFNRc {}
 - {} MSRN
 - {} IMS {}
5. {} {} MT {}







{} {}

- {} `{sip_local_network_addr}` {} TAS IP {} `10.179.3.60` {}
- {} MT {}
- {} `sip_invite_call_id` {} ID {}
- {} MT {} MSRN {}
- {} CDR {}

- On-net MT
- TAS IP `allowed_sbc_source_ips`

Prometheus



OmniTAS  Prometheus     





 `http://<tas-ip>:8080/metrics`



Diameter

`diameter_response_duration_milliseconds`



 Histogram

 `application` (ro, sh), `command` (ccr, cca, ) , `result` (success, error, timeout)

 10, 50, 100, 250, 500, 1000, 2500, 5000, 10000 ms

 Diameter  



```
#  Diameter   
rate(diameter_response_duration_milliseconds_sum[5m]) /  
rate(diameter_response_duration_milliseconds_count[5m])  
  
# P95 Diameter   
histogram_quantile(0.95,  
rate(diameter_response_duration_milliseconds_bucket[5m]))
```



- P95 > 1000ms - Diameter

diameter_requests_total

Counter

application (ro, sh), command (ccr, udr,)

Diameter

```
#  
rate(diameter_requests_total[5m])
```

diameter_responses_total

Counter

application (ro, sh), command (ccr, udr,), result_code (2001, 3002, 5xxx,)

Diameter

```
#  
rate(diameter_responses_total{result_code="2001"}[5m]) /  
rate(diameter_responses_total[5m]) * 100
```

diameter_peer_state

Gauge

peer_host, peer_realm, application (ro, sh)

Diameter (1=up, 0=down)

10

```
#  
diameter_peer_state == 0
```

- P95 > 2000ms - HTTP 请求
- P95 > 3000ms - 请求
- P99 > 5000ms - 请求
- 请求 `call_type="unknown"` - 请求

请求

- 请求
- 请求 P50: 100-500ms, P95: 500-2000ms, P99: 1000-3000ms
- 请求 (Sh + HLR + OCS + 请求)
- 请求 (subscriber_data, hlr_data, ocs_authorization)
- 请求 100ms (请求) 或 5000ms (请求/请求)

请求

- 请求 `dialplan_generation_duration_milliseconds` 请求 XML 请求
- 请求 FreeSWITCH/SBC 请求
- 请求 SLA 请求

2. 请求

`subscriber_data_duration_milliseconds`

请求 Histogram

请求 `result` (success, error)

请求 或 Sh 请求 (HSS) 请求

请求

```
# 请求 Sh 请求
rate(subscriber_data_duration_milliseconds_sum[5m]) /
rate(subscriber_data_duration_milliseconds_count[5m])

# 请求 95 请求 Sh 请求
histogram_quantile(0.95,
  rate(subscriber_data_duration_milliseconds_bucket[5m])
)
```

□□□□

- P95 > 100ms - HSS □□□□
- P95 > 500ms - □□ HSS □□□□

subscriber_data_lookups_total

□□□ Counter

□□□ result (success, error)

□□□ □□□□□□□□□□

□□□

```
# Sh □□□□
rate(subscriber_data_lookups_total[5m])

# Sh □□□
rate(subscriber_data_lookups_total{result="error"}[5m])

# Sh □□□□□□
(rate(subscriber_data_lookups_total{result="success"}[5m]) /
rate(subscriber_data_lookups_total[5m])) * 100
```

□□□□

- □□□ > 5% - HSS □□□□
- □□□ > 20% - □□ HSS □□

2. HLR □□□□

hlr_data_duration_milliseconds

□□□ Histogram

□□□ result (success, error)

□□□ □□ SS7 MAP □□ HLR □□□□□

□□□

```
# HLR 平均
rate(hlr_data_duration_milliseconds_sum[5m]) /
rate(hlr_data_duration_milliseconds_count[5m])

# 95 分位 HLR 平均
histogram_quantile(0.95,
  rate(hlr_data_duration_milliseconds_bucket[5m])
)
```

問題

- P95 > 500ms - SS7 MAP 問題
- P95 > 2000ms - SS7 MAP 問題

hlr_lookups_total

Counter

result_type (msrn, forwarding, error, unknown)

HLR 問題

問題

```
# HLR 平均
rate(hlr_lookups_total[5m])

# MSRN 平均 (問題)
rate(hlr_lookups_total{result_type="msrn"}[5m])

# 問題
rate(hlr_lookups_total{result_type="forwarding"}[5m])

# HLR 問題
rate(hlr_lookups_total{result_type="error"}[5m])
```

問題

- 問題 > 10% - SS7 MAP 問題
- MSRN 問題 - 問題

□□□

- □ MSRN □□□□□□□□□□
- □□□□□□□□□□
- □□□□□□□□□□□□□□

3. OCS □□□□

ocs_authorization_duration_milliseconds

□□□ Histogram

□□□ **result** (success, error)

□□□ OCS □□□□□□

□□□

```
# □□ OCS □□□□
rate(ocs_authorization_duration_milliseconds_sum[5m]) /
rate(ocs_authorization_duration_milliseconds_count[5m])

# □ 95 □□□ OCS □□□□
histogram_quantile(0.95,
  rate(ocs_authorization_duration_milliseconds_bucket[5m])
)
```

□□□□□

- P95 > 1000ms - OCS □□□□
- P95 > 5000ms - □□ OCS □□□□

ocs_authorization_attempts_total

□□□ Counter

□□□ **result** (success, error), **skipped** (yes, no)

□□□ OCS □□□□□□

□□□

```

# OCS 실패율
rate(ocs_authorization_attempts_total{skipped="no"}[5m])

# OCS 실패율
rate(ocs_authorization_attempts_total{result="error",skipped="no"}
[5m])

# OCS 실패율 (오류율)
rate(ocs_authorization_attempts_total{skipped="yes"}[5m])

# OCS 성공률
(rate(ocs_authorization_attempts_total{result="success",skipped="no"}
[5m]) /
rate(ocs_authorization_attempts_total{skipped="no"}[5m])) * 100

```

이벤트

- 실패율 > 5% - OCS 실패율
- 실패율 < 95% - OCS 실패율

이벤트

- 실패율/성공률
- 실패율 OCS 실패율
- 실패율

4. 이벤트

`call_param_errors_total`

이벤트 Counter

이벤트 `error_type` (parse_failed, missing_required_params)

이벤트 이벤트

이벤트

```
# 00000
rate(call_param_errors_total[5m])

# 0000000
rate(call_param_errors_total[5m]) by (error_type)
```

00000

- 0000 > 0 - 0000000000000000
- 00 > 1% 0000 - 0000

authorization_decisions_total

000 Counter

000 disposition (mt, mo, emergency, unauthorized), result (success, error)

000 00000000000

000

```
# 00000000
rate(authorization_decisions_total[5m]) by (disposition)

# MT 000
rate(authorization_decisions_total{disposition="mt"}[5m])

# MO 000
rate(authorization_decisions_total{disposition="mo"}[5m])

# 00000
rate(authorization_decisions_total{disposition="emergency"}[5m])

# 0000000
rate(authorization_decisions_total{disposition="unauthorized"}
[5m])
```

00000

- 0000 > 1% - 000000000000
- 0000000 - 00000000

- MT/MO 00000000 - 000000

0000

- MT/MO 0000000000
- 0000000000000000
- 000000000000

freeswitch_variable_set_duration_milliseconds

0000 Histogram

0000 batch_size (1, 5, 10, 25, 50, 100)

0000 0000000000000000

0000

```
# 0000000000
rate(freeswitch_variable_set_duration_milliseconds_sum[5m]) /
rate(freeswitch_variable_set_duration_milliseconds_count[5m])

# 0000000000000000
histogram_quantile(0.95,
  rate(freeswitch_variable_set_duration_milliseconds_bucket[5m])
) by (batch_size)
```

000000

- P95 > 100ms - 0000000000
- 0000 - 000000000000

5. 00000000

dialplan_module_duration_milliseconds

0000 Histogram

0000 module (MT, MO, Emergency, CallParams, 0), call_type

0000 0000000000000000

0000

```

# P95
histogram_quantile(0.95,
  rate(dialplan_module_duration_milliseconds_bucket[5m])
) by (module)

# MT P95
histogram_quantile(0.95,
  rate(dialplan_module_duration_milliseconds_bucket{module="MT"}
[5m])
)

```

📊

- P95 > 500ms - 📊
- 📊 - 📊

📊

- 📊
- 📊
- 📊📊📊📊📊📊📊

6. 📊

`call_attempts_total`

📊 Counter

📊 `call_type` (mt, mo, emergency, unauthorized), `result` (success, rejected)

📊 📊📊📊

📊

```

# 成功割合
rate(call_attempts_total[5m])

# 成功割合の割合
(rate(call_attempts_total{result="success"}[5m]) /
 rate(call_attempts_total[5m])) * 100 by (call_type)

# 拒否割合
rate(call_attempts_total{result="rejected"}[5m])

```

まとめ

- 成功割合 > 5% - 成功割合
- 成功割合の割合 - 成功割合
- 拒否割合 - 成功割合

active_calls

📊 Gauge

📊 `call_type` (mt, mo, emergency)

📊 📊 📊

📊

```

# 成功割合
active_calls

# 成功割合の割合
active_calls by (call_type)

# 最大値 (1時間)
max_over_time(active_calls[1h])

```

まとめ

- 成功割合 > 5% - 成功割合
- 成功割合 = 0 成功割合の割合 - 成功割合

7. 计数器

`call_simulations_total`

计数器 Counter

计数器 `call_type` (mt, mo, emergency, unauthorized), `source` (web, api)

计数器 计数器

计数器

```
# 计数器
rate(call_simulations_total[5m])

# 计数器
rate(call_simulations_total[5m]) by (call_type)
```

计数器

- 计数器
- 计数器
- 计数器

8. SS7 MAP 计数器

`ss7_map_http_duration_milliseconds`

计数器 Histogram

计数器 `operation` (sri, prn), `result` (success, error, timeout)

计数器 10, 50, 100, 250, 500, 1000, 2500, 5000, 10000 ms

计数器 SS7 MAP HTTP 计数器

计数器

```
# SS7 MAP 计数器
rate(ss7_map_operations_total{result="error"}[5m]) /
rate(ss7_map_operations_total[5m]) * 100
```

计数器

- P95 > 500ms - SS7 MAP
- > 50% - SS7 MAP

ss7_map_operations_total

Counter

operation (sri, prn), result (success, error)

SS7 MAP

9.

online_charging_events_total

Counter

event_type (authorize, answer, reauth, hangup), result (success, nocredit, error, timeout)

```
# OCS
```

```
rate(online_charging_events_total{result="nocredit"}[5m])
```

-

10.

tracked_registrations

Gauge

SIP FreeSWITCH Sofia

10

- FreeSWITCH

tracked_call_sessions

Counter Gauge

ETS (dialplan, call_event, directory, voicemail, sms_ccr, metrics)

status_code (200, 400, 500, ...)

11. HTTP 5xx

http_requests_total

Counter

endpoint (dialplan, call_event, directory, voicemail, sms_ccr, metrics),

status_code (200, 400, 500, ...)

HTTP 5xx

Alert

```
# HTTP 5xx
rate(http_requests_total{status_code=~"5.."}[5m]) /
rate(http_requests_total[5m]) * 100
```

Alert

- HTTP 5xx > 10%

12. Call Rejections

call_rejections_total

Counter

call_type (mo, mt, emergency, unknown), reason (nocredit, unauthorized, parse_failed, missing_params, hlr_error, ...)

Alert

Alert

```
# Call Rejections
sum by (reason) (rate(call_rejections_total[5m]))
```

□□□□

- □□□ > 1/sec - □□□□

13. □□□□□□□□

event_socket_connected

□□□ Gauge

□□□ connection_type (main, log_listener)

□□□ □□□□□□□□□□ (1=connected, 0=disconnected)

□□□□□ □□□□□□□□□□□□

□□□

```
# □□□□□□□□□□  
event_socket_connected
```

□□□□□

- □□□□□□ 30 □

event_socket_reconnections_total

□□□ Counter

□□□ connection_type (main, log_listener), result (attempting, success, failed)

□□□ □□□□□□□□□□□□

Grafana □□□□□

□□□□ Prometheus □□□□ Grafana □□□□□□□□□□□□□□□□

□□□ **1**□□□□□

- □□□□□□
- □□□□□□□□□□□□ (MO/MT/□□)
- □□□□□□

☐☐☐ **2 Diameter** ☐☐

- ☐☐☐☐☐☐
- ☐☐/☐☐☐☐
- ☐☐☐☐☐☐
- ☐☐☐☐☐☐☐☐☐☐

☐☐☐ **3**☐☐☐☐☐☐☐☐☐

- ☐☐☐☐☐☐☐☐
- “☐☐☐”☐☐☐
- OCS ☐☐☐

☐☐☐ **4**☐☐☐☐☐☐

- ☐☐☐☐☐☐☐☐ (P50/P95/P99)
- SS7 MAP ☐☐☐☐
- ☐☐☐☐☐☐☐☐

☐☐☐ **Grafana** ☐☐☐☐☐☐

☐ **1**☐☐☐☐

- ☐☐☐☐☐☐☐☐☐☐☐☐
- ☐☐☐☐☐☐☐
- ☐☐☐☐☐☐☐

☐ **2**☐☐☐☐

- P95 HTTP ☐☐☐☐☐☐☐☐☐☐ (☐☐☐☐☐☐) - ☐☐☐☐☐
- P95 Sh ☐☐☐☐☐
- P95 HLR ☐☐☐☐☐
- P95 OCS ☐☐☐☐☐
- P95 ☐☐☐☐☐☐☐☐☐☐☐☐ (☐☐☐☐)

☐ **3**☐☐☐☐☐

- Sh 00000
- HLR 00000
- OCS 00000
- 0000000

4 00000

- 0000 P95 0000
- 000000

5 000

- 0000
- 00000
- Sh 00
- HLR 00
- OCS 00

0000

000 1 (0000)0

```
# 00000000
rate(call_attempts_total[5m]) == 0

# HSS 0000
rate(subscriber_data_lookups_total{result="error"}[5m]) /
rate(subscriber_data_lookups_total[5m]) > 0.9

# OCS 0000
rate(ocs_authorization_attempts_total{result="error"}[5m]) /
rate(ocs_authorization_attempts_total[5m]) > 0.9
```

000 2 (00)0

```
# 0000000000
histogram_quantile(0.95,
  rate(dialplan_generation_duration_milliseconds_bucket[5m])
) > 1000

# 0 HSS 000
rate(subscriber_data_lookups_total{result="error"}[5m]) /
rate(subscriber_data_lookups_total[5m]) > 0.2

# 0 OCS 000
rate(ocs_authorization_attempts_total{result="error"}[5m]) /
rate(ocs_authorization_attempts_total[5m]) > 0.1
```

000 3 (00)0

```
# HSS 0000
histogram_quantile(0.95,
  rate(subscriber_data_duration_milliseconds_bucket[5m])
) > 100

# OCS 0000
histogram_quantile(0.95,
  rate(ocs_authorization_duration_milliseconds_bucket[5m])
) > 1000

# 00000
rate(call_attempts_total{result="rejected"}[5m]) /
rate(call_attempts_total[5m]) > 0.05
```

□□□□

Diameter □□□□□

```
alert: DiameterPeerDown
expr: diameter_peer_state == 0
for: 1m
annotations:
  summary: "Diameter □□ □{ $labels.peer_host } □□"
```

□ Diameter □□

```
alert: HighDiameterLatency
expr: histogram_quantile(0.95,
rate(diameter_response_duration_milliseconds_bucket[5m])) > 1000
for: 5m
annotations:
  summary: "Diameter P95 □□□□ 1s"
```

OCS □□□□

```
alert: HighOCSCreditFailures
expr: rate(online_charging_events_total{result="nocredit"}[5m]) >
0.1
for: 2m
annotations:
  summary: "□ OCS □□□□□"
```

SS7 MAP 告警

```
alert: SS7MapErrors
expr: rate(ss7_map_operations_total{result="error"}[5m]) /
rate(ss7_map_operations_total[5m]) > 0.5
for: 3m
annotations:
  summary: "SS7 MAP 告警 50%"
```

告警

```
alert: EventSocketDown
expr: event_socket_connected == 0
for: 30s
annotations:
  summary: "告警 {{ $labels.connection_type }} 告警"
```

告警

```
alert: HighCallRejectionRate
expr: rate(call_rejections_total[5m]) > 1
for: 2m
annotations:
  summary: "告警{{ $value }} 告警"
```

HTTP 告警

```
alert: HighHTTPErrorRate
expr: rate(http_requests_total{status_code=~"5.."}[5m]) /
rate(http_requests_total[5m]) > 0.1
for: 3m
annotations:
  summary: "HTTP 5xx 告警 10%"
```

查詢未知通話

查詢未知通話 "unknown"

查詢

- 查詢未知通話 `call_type="unknown"` 的 `mt` 及 `mo` 及 `emergency`
- 查詢未知通話

查詢未知通話

查詢

1. 查詢未知通話 "HTTP 未知通話" 的 - 查詢未知通話
2. 查詢未知通話

查詢未知通話

查詢未知通話

查詢

1. 查詢 `http_dialplan_request_duration_milliseconds` P95 - 查詢未知通話
2. 查詢未知通話
 - 查詢 `subscriber_data_duration_milliseconds` 查詢 Sh 查詢
 - 查詢 `hlr_data_duration_milliseconds` 查詢 HLR 查詢
 - 查詢 `ocs_authorization_duration_milliseconds` 查詢 OCS 查詢
 - 查詢 `dialplan_module_duration_milliseconds` 查詢未知通話
3. 查詢 `call_type="unknown"` - 查詢未知通話
4. 查詢 MT 及 MO 查詢未知通話
5. 查詢未知通話

查詢未知通話

查詢未知通話

查詢

1. `call_attempts_total{result="rejected"}` 00
2. `subscriber_data_lookups_total{result="error"}` 000 Sh 00
3. `hlr_lookups_total{result_type="error"}` 000 HLR 00
4. `ocs_authorization_attempts_total{result="error"}` 000 OCS 00
5. `authorization_decisions_total{disposition="unauthorized"}` 00000
00

00000 0000000

00000000

000

1. `active_calls` 000
2. `call_attempts_total` 00
3. 0000000000000000
4. 00 MT 0 MO 00
5. 00000000000000000000

00000 0000000000

000000000

000

1. `hlr_lookups_total{result_type="msrn"}` 00
2. `hlr_data_duration_milliseconds` 000000
3. 00 HLR 00000000000000
4. 000000000 MSRN

00000 00 HLR 000000

□□□□□

□□□□□□□□

1. □□□□□□ → □□□□□□ ERROR □□
2. □□□□□□ → □□□□□□ WARNING □□□□□□
3. □□□□□□ → □□□ ID □□□□□□□□□□
4. □□□□□□□□□□□□

□□□□

1. □□□□□□□□□□□□
2. □□□□□□□□□□
3. □□□□□□□□□□□□
4. □□□□□□□□□□
5. □□□□□□□□□□□□□□□□□□
6. □□□□□□□□□□□□□□
7. □□□□□□□□□□
8. □□□□□□□□□□

□□

□□□□□□□□□□□□□□□□□□□□□□ API □□□□□□□□□□□□8080□□

□□□ Prometheus □□□□□□□□□□□□□□□□ `prometheus.yml` □□

```
scrape_configs:
  - job_name: 'omnitas'
    static_configs:
      - targets: ['<tas-ip>:8080']
    metrics_path: '/metrics'
    scrape_interval: 10s
```

□□□□

□□□□□□□□□□□□□□□□ Prometheus□

- □□□□□□ □□□□□□□□□□
- □□□□□ □□□ (mo, mt, emergency, unauthorized)
- □□□□□□ □□□□□□□□□□ Diameter/OCS □□□□
- □□□□ □□□□□□□□□□ (sri/prn □□ MAP, ccr/cca □□ Diameter)

□□□□□□□□□□□~200-500□□□□□□□□□□□□□□□□□□□□□□□□

□□□□

□□□□□□□□

- □□□□□□ 30 □□□□□□□□□□
- **5** □□□□□□ 90 □
- **1** □□□□□□ 1 □
- □□□□□□ 5 □

□□□□

- □□□□□□□□□□□□□□□□
- □□/□□□□□5 □□/1 □□□□□□
- □□□□□□□□□□□□
- □□□□□□□□□□□□

HLR 查詢與管理 - 查詢

查詢

查詢 HLR 數據的步驟如下：

HLR 查詢

查詢

HLR 查詢 SS7 MAP 查詢 HLR 數據的步驟如下：

查詢

查詢 `/hlr` 查詢 HLR 數據

查詢

查詢 HLR 數據的步驟如下：

1. MSRN 查詢

- 查詢 2G/3G 數據
- 查詢 HLR 數據
- 查詢 HLR 數據

2. 查詢

- 查詢 HLR 數據
- 查詢 HLR 數據
- 查詢 HLR 數據
- 查詢 HLR 數據

3. 查詢

- 查詢號碼狀態
- 查詢號碼是否被註冊
- 向 HLR 查詢號碼 Sh 碼

查詢

查詢

查詢 查詢號碼 查詢 查詢號碼

查詢

1. 向 HLR 查詢
2. 查詢號碼
3. 向 "HLR 碼"
4. 查詢號碼 MSRN
5. 向 MSRN 查詢號碼 MSRN 碼
6. 查詢 MSRN 號碼 LTE/VoLTE 號碼 MSRN

查詢

查詢 查詢號碼

查詢

1. 向 HLR 查詢
2. 查詢號碼
3. 向 "HLR 碼"
4. 查詢號碼 "查詢"
5. 查詢號碼
6. 查詢號碼
7. 向 HLR 查詢號碼 Sh/HSS 碼

向 HLR 查詢

查詢 查詢 SS7 MAP 查詢號碼

查詢

1. HLR
- 2.
3. "HLR"
4. "
5. SS7 MAP
6.
 - o "SS7 MAP" -
 - o "HLR" - HLR
 - o "VLR" -

HLR

- MSRN
- HLR
-
- SS7 MAP

??

/simulator " "

- 1.

- 認證
- MT 認證
- MO 認證

2. 認證

- 認證
- MT 認證
- MO 認證
- 認證 "urn:service:sos" 認證

3. IP 認證

- SIP 認證 IP 認證
- allowed_sbc_source_ips MT allowed_cscf_ips MO
- MT MO

4. 認證

- IP 認證
- MT 認證
- MO 認證
- 認證

5. 認證

- OCS 認證
- HLR 認證 SS7 MAP 認證

認證

認證

1. 認證

- MT MO 認證
- 認證
- 認證

2. 呼叫流程

- 呼叫流程 Sh 呼叫流程HSS
- **HLR** 呼叫 SS7 MAP 呼叫流程 MT
- **OCS** 呼叫流程MO
- 呼叫流程MO

3. 呼叫流程

- 呼叫流程
- 呼叫流程
- 呼叫流程

4. 呼叫

- 呼叫
- 呼叫
- 呼叫

呼叫

呼叫

呼叫 呼叫流程

呼叫

1. 呼叫/呼叫流程

2. 呼叫流程

3. 呼叫流程

- 呼叫 SBC 呼叫 MT
- 呼叫 CSCF 呼叫 MO
- 呼叫
- 呼叫
- 呼叫

4. 呼叫流程

5. 呼叫流程

6. 呼叫失败原因

呼叫 MT 失败

呼叫失败原因

原因

1. 呼叫失败
2. 呼叫失败原因
3. 呼叫失败原因
4. 呼叫 IP 地址 SBC IP
5. 呼叫失败原因 "失败"
6. 呼叫 "失败???"
7. 呼叫失败原因 Sh 失败
8. 呼叫 HLR 失败原因 MSRN 失败
9. 呼叫失败原因 hangup_case
10. 呼叫 hangup_case 为 "UNALLOCATED_NUMBER"失败
11. 呼叫失败原因

呼叫 MO 失败

呼叫失败原因

原因

1. 呼叫失败
2. 呼叫失败原因
3. 呼叫失败原因
4. 呼叫 IP 地址 CSCF IP
5. 呼叫失败原因 "失败 OCS 失败"
6. 呼叫 "失败"
7. 呼叫失败原因 Sh 失败
8. 呼叫 OCS 失败原因/失败
9. 呼叫失败原因
10. 呼叫失败原因 allocated_time 为 hangup_case

11. 當 `hangup_case` 為 "OUTGOING_CALL_BARRED" 時 OCS 會做什麼

會做什麼

當 會做什麼

會

1. 會
2. 會
3. 會 "urn:service:sos"
4. 會 IP 會 IP 會
5. 會 "會"
6. 會 "會SOS"
7. 當 `hangup_case` 為 "none" 會
8. 會 OCS 會 HLR 會
9. 會

會

當 會

會

1. 會
2. 會
 - 會 MT 會 Sh + HLR 會
 - 會 MO 會 OCS 會
 - 會
 - 會 IP 會
3. 會
4. 會
5. 會

會 **Sh** 會 **HLR** 會

會 會 HLR 會 Sh 會

□□

1. □□ MT □□□□□□□□
2. □□□□ "□□ HLR □□"
3. □□ "□□□□"
4. □□□□□□□□□□ HLR □□□□
5. □□□□□□□□□□□□□□
6. □□□□HLR □□□□□□□□
 - MSRN
 - `call_forward_all_destination`
 - `call_forward_not_reachable_destination`

□□

- □□□□□□□□□□□□ "□□ OCS □□" □ "□□ HLR □□" □□□□□□□□
- □□□□□□□□□□□□□□□□□□□□□□□□□□□□
- □□ "□□□□" □□□□□□□□□□□□ IP □□
- □□□□□□□□□□□□□□□□□□□□□□□□□□□□
- □□□□□□□□□□□□□□□□□□□□□□□□□□□□
- □□□□□□□□□□□□□□□□□□□□□□□□□□□□

□□

□□□□

- □□□□□□□□□□
- □□□□□□□□□□
- □□□□ OCS □□□□□□□□□□ OCS□
- □□□□ CDR
- □□□□□□□□□□□□□□□□□□□□□□□□□□□□

□□□□□

- □□□□□□□□□□□□□□ Sh □□□□HSS□
- □□□□□□□□□□□□□□□□□□□□□□□□□□□□ HLR

- 000000000000 OCS
- 00000000000000000000
- 00000000

000000

000000 Prometheus 000000

- 000000 HLR 0000 `hlr_lookups_total`
- 000000 `call_simulations_total{call_type, source}`
- 00000000000000000000

000000

- 000000000000
- 0000000000
- 00000000000000

0000000000 0000 [metrics.md](#) 0000000000000000000000

000000

1. 0000000000

- 0000000000
- 0000000000
- 0000000000

2. 00 **HLR** 00

- 0000000000
- 0000 HLR 000000
- 00 SS7 MAP 0000

3. 0000

- 0000000000000000
- 0000000000000000
- 0000000000000000

4. 00000000

- 0000000000000000
- 0000000000000000
- 0000

5. 0000

- 000000000000
- 0000000000MT/MO/0000
- 00 OCS 0 HLR 00

00000000

HLR 0000

0000 "SS7 MAP 0000"

- 00 config/runtime.exe 00 ss7_map.enabled
- 000000000000

00000000

- 00 SS7 MAP 000000
- 000 HLR 000000
- 000000 ss7_map.timeout_ms

0000 "00 VLR 00"

- 000000 HLR 0000
- 00000000000000
- 00000000000000

□□□□□□□

□□□□□ "□□ **Sh** □□"

- □□□□ HSS □□□
- HSS □□□□
- □□ `diameter.sh_application` □□

□□□□□ "□□ **IP** □□□"

- IP □□ `allowed_sbc_source_ips` □□ `allowed_cscf_ips` □□
- □□ "□□□□□" □□□□□ IP □□□

□□□□□ "□□□□□□□"

- □□□□□□□□□□□□□□□□
- □□□□□□□□□□
- □□□□□□ IP □□□

□□□□□□□□

- □□□□□□□□□□□□ "□□ OCS □□□"
- □□□□□□□□□□□□ "□□ HLR □□□"
- □□□□□□□□□□□□□□□□□□□□□□□□□□□□□□□□

□□

□□□□□□□□□□

1. □□□□□□□□□□□□□□□□
2. □□□□□□□□□□□□□□□□□□□□□□□□□□□□□□□□
3. □□□□□□□□□□□□□□□□□□□□□□□□□□□□□□□□
4. □□□□□□□□□□□□□□□□□□□□□□□□□□□□□□□□

HOMER

OmniTAS SIP Call-ID

Overview

OmniTAS sends SIP Call-ID to Homer via HEP3. Homer then forwards the data to the HOMER HEP3 server (UDP 9060), which stores it in a database and provides a Web UI.

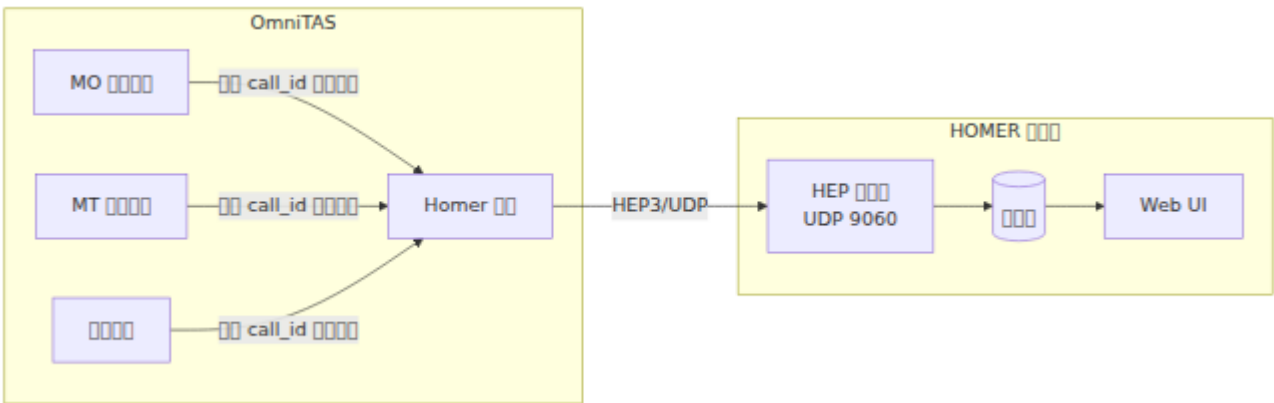

Steps

- Configure OmniTAS to send SIP Call-ID
- Configure Homer to use PubSub
- Configure `call_id` field
- HEP3** server listening on HEP3 port 100
- Configure HOMER HEP3 Call-ID to SIP

Commands

```
homer_server config/runtime.exs
```

```

config :tas,
  homer_server: %{
    host: "10.179.2.136",
    port: 9060,
    auth_key: nil,
    capture_id: 2001
  }

```

□□

□□	□□	□ □	□□	□□
host	□□ □	□	-	HOMER □□ IP □□□□□□
port	□□	□	9060	HEP □□ UDP □□
auth_key	□□ □	□	nil	□□ HEP □□□□□□□□□□□□□□□□ heplify-server □□□□ authkey □□
capture_id	□□	□	2001	□□□□□□□□ HOMER UI □□□□□□□□□□

□□ HOMER □□

□□□ HOMER □□□□□□

- □□□□ homer_server □□□□
- □□□□□□

□□□□Homer □□□□□□□□□□□□□□□□□□

HOMER □□□□□□

HOMER □□□□□□□ heplify-server□□□□ UDP □□ HEP □□□□

heplify-server

heplify-server.toml

```
HEPAddr = "0.0.0.0:9060"
```

OmniTAS 100 heplify-server logs_capture HOMER

Call-ID

OmniTAS Call-ID

- **MO**
- **MT**
-

HOMER

項目	説明
Call ID	Call ID SIP Call-ID
発信元	発信元
宛先	宛先
通話時間	通話時間
通話状態	通話状態
IP	OmniTAS IP IP
Call ID	Call ID

HOMER ログ

HOMER ログ

```
[info] 61400123456 61400654321 M0
[debug] 61400123456
[info] OCS 120
[debug] hangup_case = none
```

HOMER SIP INVITE 200 OK BYE

HEP3 ログ

OmniTAS HOMER HEP3 Kamilio siptrace

□□□□□□

□ ID	□□	□□
0x0001	IP □□	□□□ 2□IPv4□
0x0002	IP □□	□□□ 17□UDP□
0x0003	□ IPv4	OmniTAS □□□□□
0x0004	□□ IPv4	HOMER □□□□□
0x0007	□□□	0□□□□□□□□
0x0008	□□□□	□□□ HEP □□
0x0009	□□□□	Unix □□□□
0x000A	□□□□□	□□□□□
0x000B	□□□□	100□□□□□
0x000C	□□ ID	□□□ capture_id
0x0011	□□ ID	SIP Call-ID
0x000F	□□□□	□□□□□
0x000E	□□□□	□□□□□

□□□□

□□□□□□ **HOMER** □

□□□□□□□□□□ HOMER □□□□□□□□

□□□□

- HOMER □□□□□□□□□□□□
- □□□□ UDP □□□□ 9060
- heplify-server □□□□□ HEP
- □□□□ call_id □□□

□□□□

1. □□□□□□ nc -zvu <homer_host> 9060
2. □□ heplify-server □□□□□ ss -u lnp | grep 9060
3. □□ heplify-server □□□□□□□□□□
4. □□ call_id □□□□ OmniTAS □□□□□□□□□□□□ call_id=□

□□□□

□□□ heplify-server □□□□□□□□

□□□□

- OmniTAS ❓❓❓ heplify-server □□□ auth_key □□□
- □□□□□□□□□□□□□□□□

□□□□

1. □□ heplify-server □□□□□□□□□□□□ OmniTAS □□□ auth_key: nil
2. □□ heplify-server □□□□□□□□□□□□□□□□□□

□□□□

□□□□□□□□ HOMER □□□□□ SIP □□□□

□□□□

- SIP □□□□□□ Call-ID □□□□□
- HOMER □□□□

□□□□

1. `Call-ID` `SIP Call-ID`
2. `HOMER` `logs_capture`

`HOMER`

OmniTAS

`HEP`

```
[warning] HEP Homer<reason>
```

heplify-server

`heplify-server` `Prometheus`

- `heplify_packets_total{type="log"}` -
- `heplify_packets_dropped_total` -

□□□□

□□□□

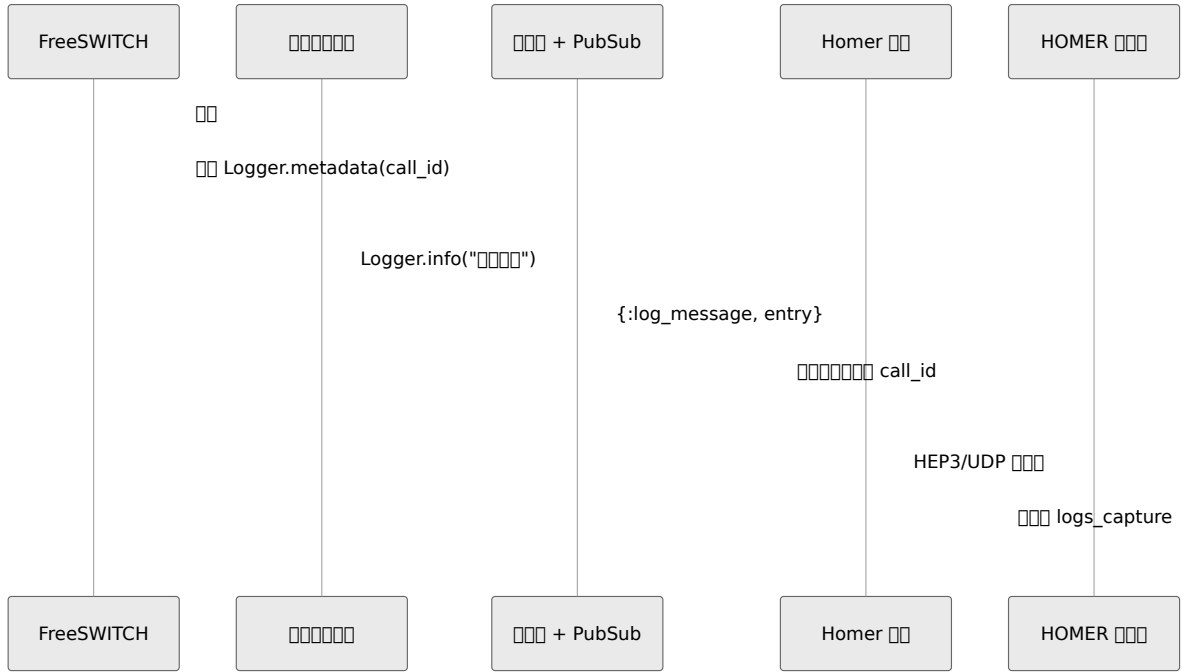

□□□

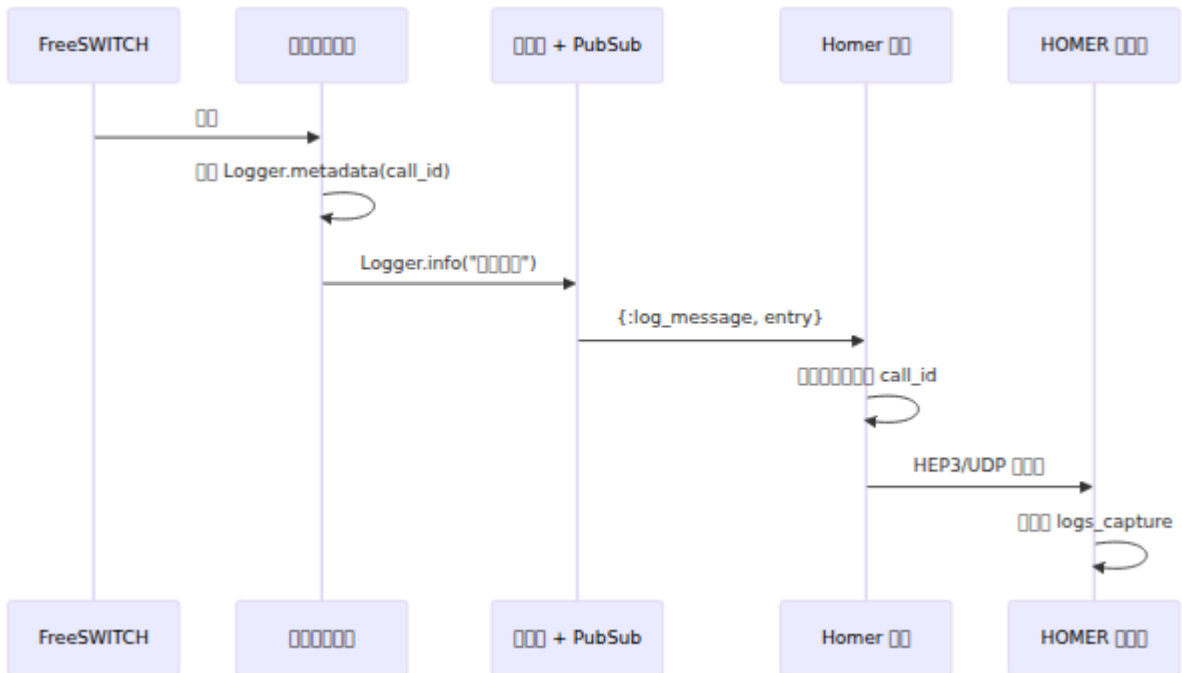



- HOMER [link](#) - VoIP/RTC [link](#)
- HEP [link](#) - HEP/EEP [link](#)
- [heplify-server](#) - HEP [link](#)

IMS 3GPP IMS - SIP

IMS

IMS 3GPP IMS (RFC 4579, RFC 4575, TS 24.147) SIP
IMS SIP

IMS

IMS OmniTAS SIP

- SIP **URI** SIP URI
- SIP
- SIP
- SIP

IMS SIP

TAS TS 24.147 RFC 4579 3GPP SIP

```
Parse error on line 17: ... IMS SIP] Factory[  
<br/>sip... -----  
^ Expecting 'SEMI', 'NEWLINE', 'SPACE', 'EOF', 'subgraph', 'end', 'acc_title',  
'acc_descr', 'acc_descr_multiline_value', 'AMP', 'COLON', 'STYLE', 'LINKSTYLE',  
'CLASSDEF', 'CLASS', 'CLICK', 'DOWN', 'DEFAULT', 'NUM', 'COMMA',  
'NODE_STRING', 'BRKT', 'MINUS', 'MULT', 'UNICODE_TEXT', 'direction_tb',  
'direction_bt', 'direction_rl', 'direction_lr', got 'LINK_ID'
```

IMS

SIP (RFC 4579 SIP)

SIP URI SIP

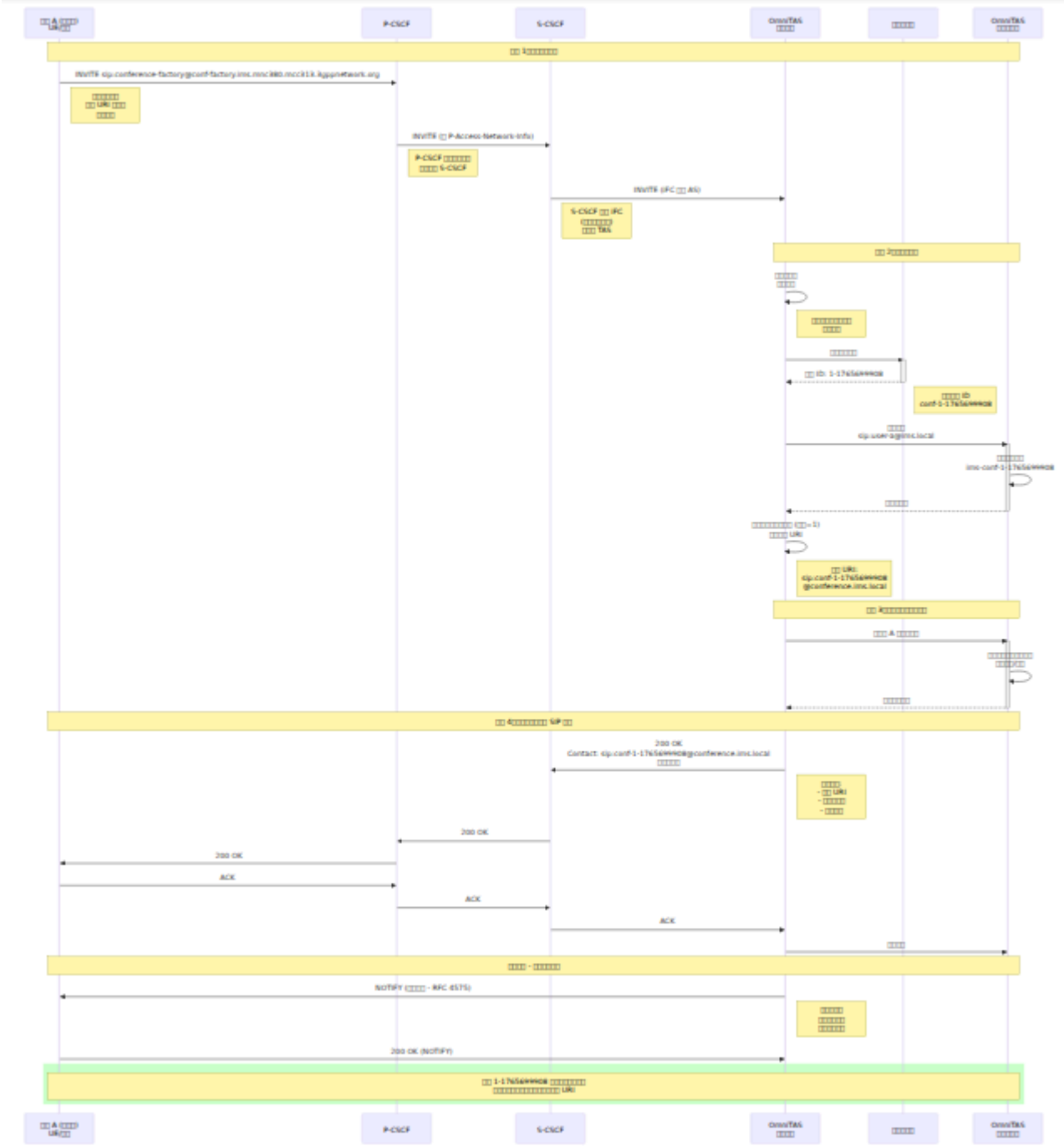

□□□□□□

□□□□□□□□□□□□□□□□

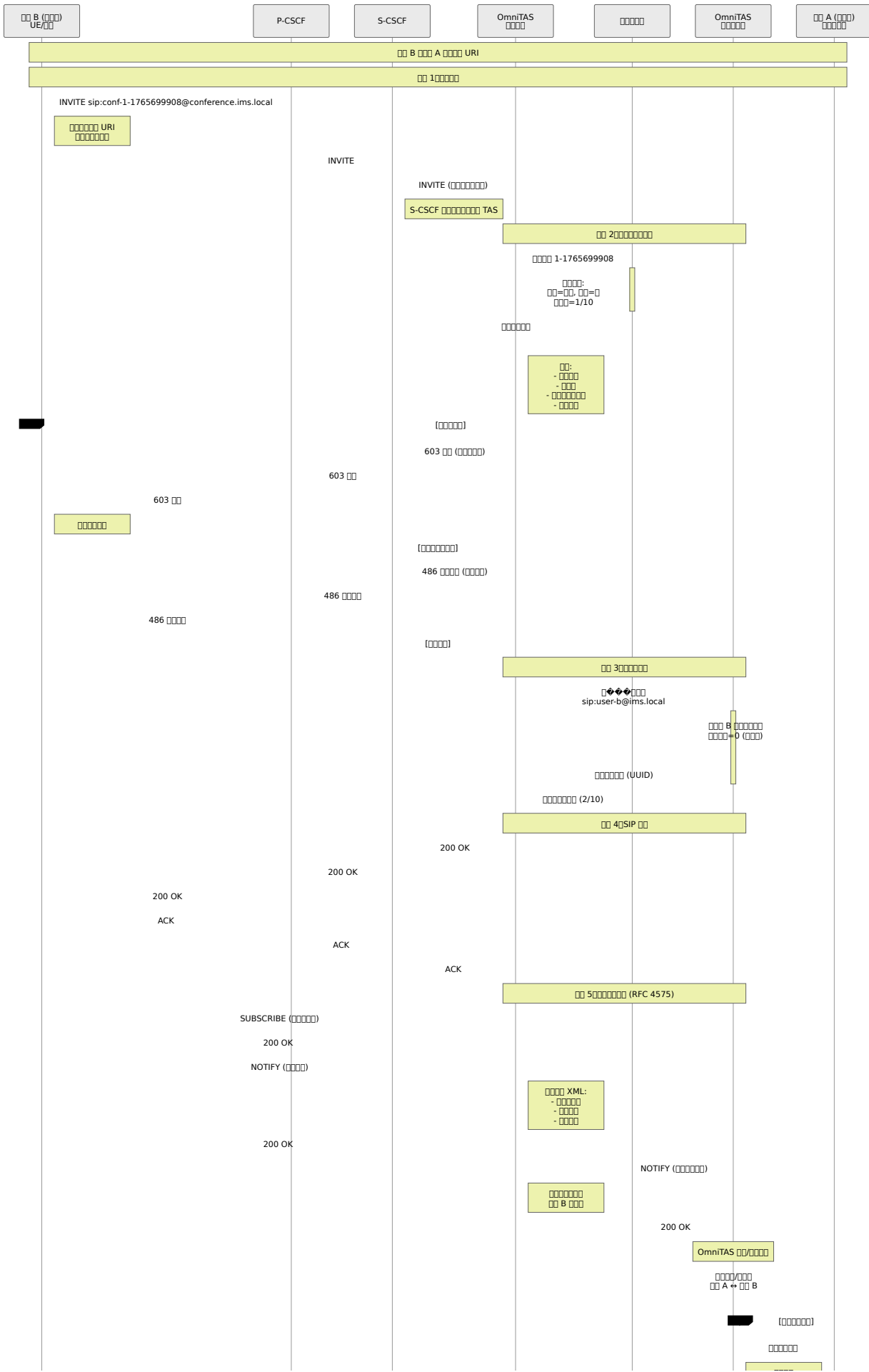

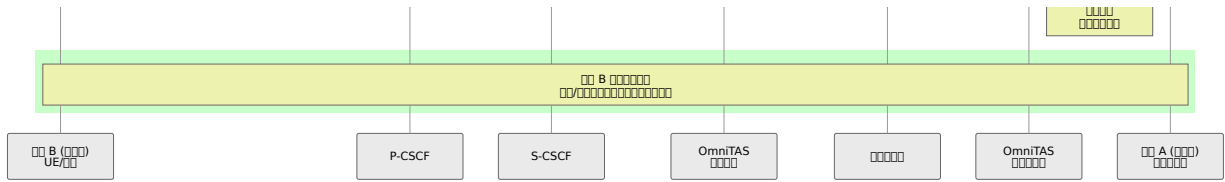

(RFC 4575)

XXXXXXXXXX - 3GPP TS 24.147

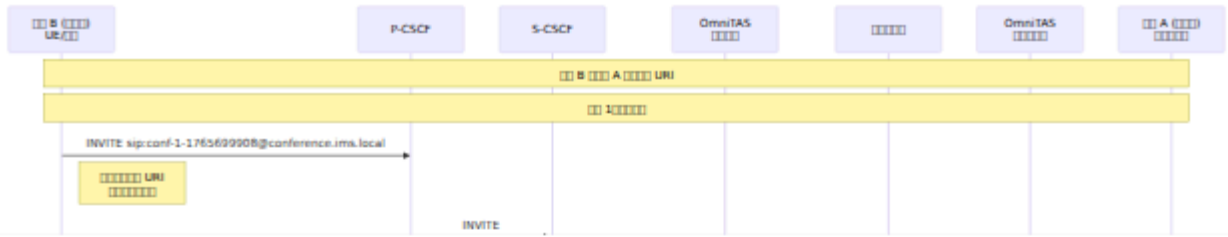

OmniCharge OmniRAN Downloads Omnitouch Website

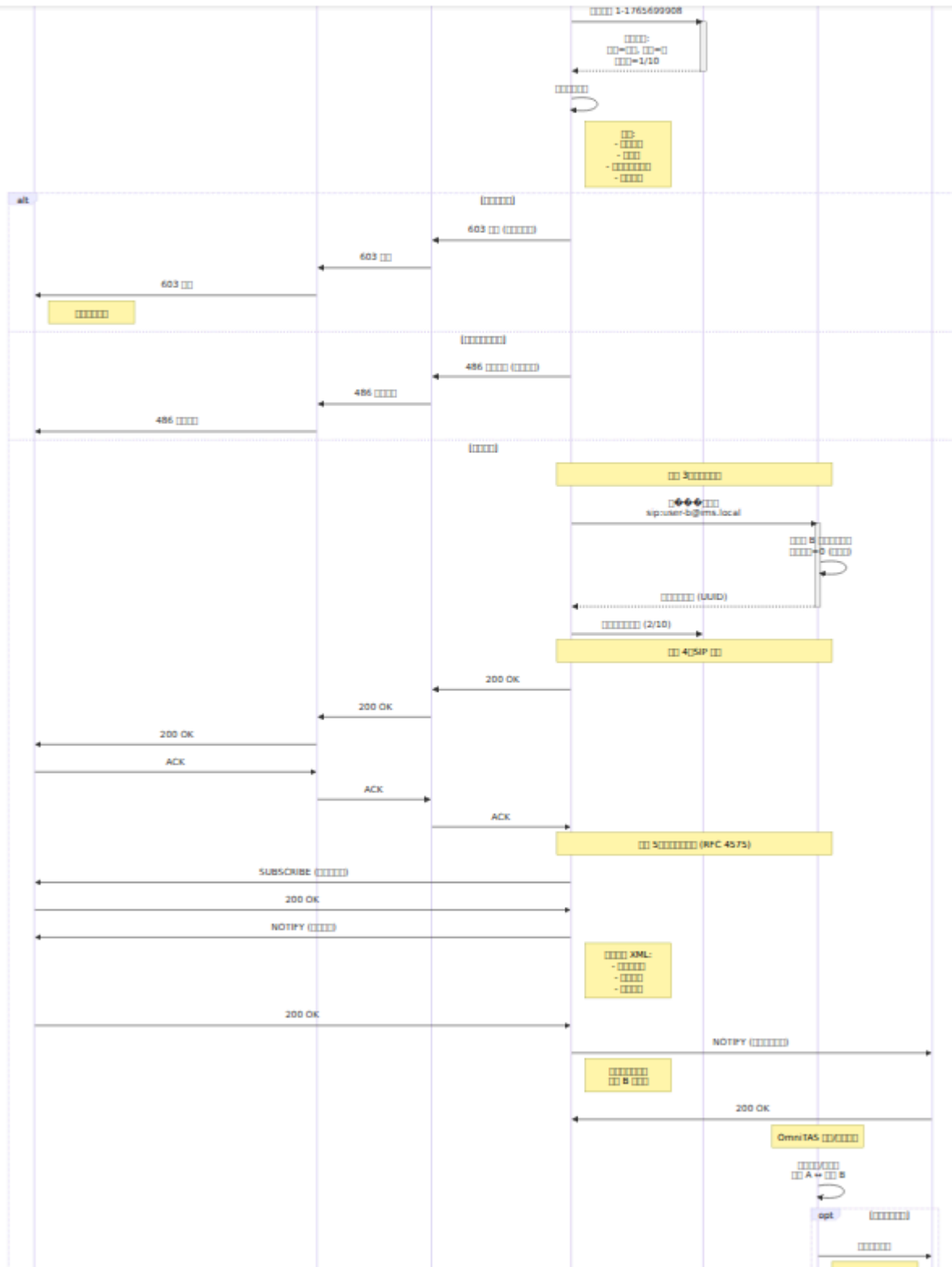

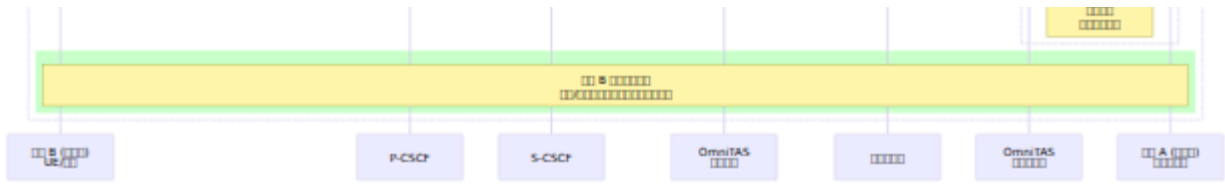

□□□□□□

□□ Web UI □ OmniTAS □□□□□□□□

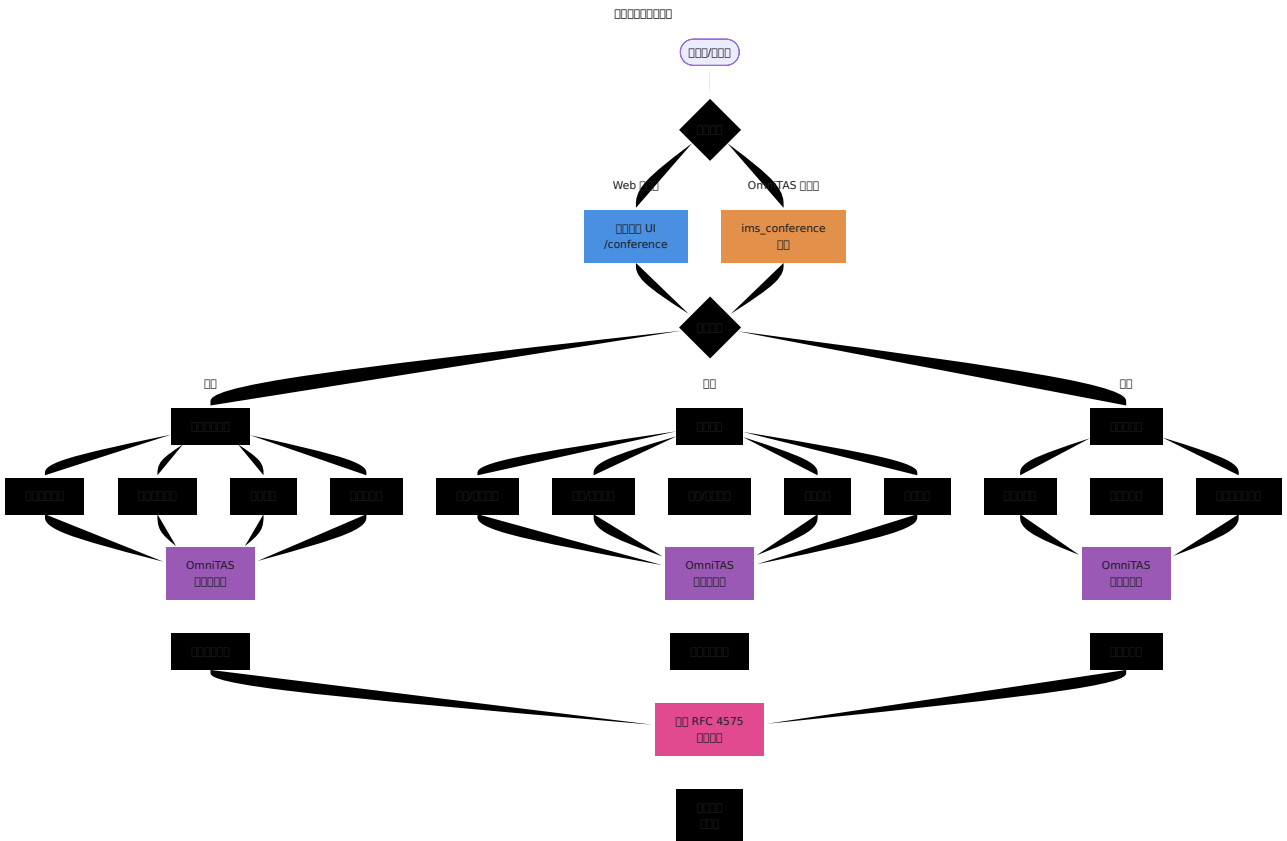

□□

Web □□

□□ /conference □□□□□□□□“□□”□□□□□□□□

OmniTAS □□□

□□ ims_conference □□□ OmniTAS □□□□□□□□□□

□□

□□□□□□

Web □□□□□□ IMS □□□□□□□□□□

□□□□

□□□□□□□□□□□□□□

- □□□□□□□□□□□□
- □□□□□□□□□□□□
- □□□□□□□□□□□□
- □□□□□□□□□□□□

□□□□□□□□□□

- □□□□□□□□ (□□□conference.ims.local)
- □□ **URI**□□□□□□□□□□ SIP URI
- **MNC/MCC**□□□□□□□□□□□□
- □□□□□□□□□□ (□□□3GPP-E-UTRAN-FDD)
- □□□□□□□□□□□□□□□□□□
- □□□□□□□□□□□□□□
- □□□□□□□□□□□□□□

□□□□

□□□□□□□□□□□□

- □□ **ID**□□□□□□□□□□
- **URI**□□□□□ SIP URI
- □□□□□□□□□□□□
- □□□□□□□□□□□□□□/URI

□□□□□□□□□□□□□□□□

□□□□

□□□□

```
ims_conference <command> [arguments]
```

□□□□

list

□□□□□□ IMS □□□

```
omnitas@server> ims_conference list
```

```
IMS □□□
```

```
□□ ID          □□ URI                               □□□ □□□
```

```
=====
```

1-1765699908	sip:conf-1-1765699908@conference.ims.local	3
19078720151		

```
□□□1 □□□
```

info

□□□□□□□□□□□□

```
□□□ ims_conference info <conf_id>
```

```
□□□ □□□ ID□□□□ 1-1765699908 □□□□□□□□□□□□□□
```

```
omnitas@server> ims_conference info 1-1765699908
```

```
#####
```

```
  ID: 1-1765699908
```

```
  URI: sip:conf-1-1765699908@conference.ims.local
```

```
  : ims-conf-1-1765699908
```

```
  : 19078720151
```

```
  : 1
```

```
  : 3/10 ( : 2)
```

```
  :  
```

```
  :  
```

```
  :  
```

```
#####
```

```
  - sip:1235;phone-
```

```
context=ims.mnc380.mcc313.3gppnetwork.org@ims.mnc380.mcc313.3gppnetwo  
(342d50e0-9f67-4cc5-9179-4acae6f65f34)
```

```
  : 3,  : 0,  :  
```

```
  - sip:1235;phone-
```

```
context=ims.mnc380.mcc313.3gppnetwork.org@ims.mnc380.mcc313.3gppnetwo  
(bd98ca37-64fd-4618-b2db-aaba108c73e2)
```

```
  : 3,  : 0,  :  
```

```
  - 19078720151 (6270da85-9b94-4285-8130-8769b11d0aa2)
```

```
  : 3,  : 1,  :  
```

stats

```
#####
```

```

omnitas@server> ims_conference stats
IMS ██████████
=====
██████1
██████3
██████1
██████0

███
  █ conference.ims.local
  █ URI sip:conference-factory@conf-
factory.ims.mnc380.mcc313.3gppnetwork.org
  MNC/MCC 380/313
  █ 3GPP-E-UTRAN-FDD
  █ 10
  █
  █
  █
  █=███=███=█

```

create

██████████

███ `ims_conference create <creator_uri>`

```

omnitas@server> ims_conference create sip:19078720151@ims.local
██████1-1765699909
██ URI sip:conf-1-1765699909@conference.ims.local

```

destroy

██████████████████

███ `ims_conference destroy <conf_id>`

```

omnitas@server> ims_conference destroy 1-1765699908
██ 1-1765699908 ███

```

add

□□□□□□□□□□□□

```
□□□ ims_conference add <conf_id> <sip_uri>
```

```
omnitas@server> ims_conference add 1-1765699908  
sip:19078720152@ims.local  
□□□□ sip:19078720152@ims.local □□□□□ 1-1765699908
```

remove

□□□□□□□□□□□□

```
□□□ ims_conference remove <conf_id> <uuid>
```

```
□□□□□ info □□□□□□□□□□□□ UUID□
```

```
omnitas@server> ims_conference remove 1-1765699908 342d50e0-9f67-  
4cc5-9179-4acae6f65f34  
□□□□ 1-1765699908 □□□□□□
```

lock

□□□□□□□□□□□□□□

```
□□□ ims_conference lock <conf_id>
```

```
omnitas@server> ims_conference lock 1-1765699908  
□□ 1-1765699908 □□□
```

unlock

□□□□□□□□□□□□

```
□□□ ims_conference unlock <conf_id>
```

```
omnitas@server> ims_conference unlock 1-1765699908
[] 1-1765699908 []
```

video

[][][][][]

```
[][] ims_conference video <conf_id> on|off
```

```
omnitas@server> ims_conference video 1-1765699908 on
[] 1-1765699908 []
```

```
omnitas@server> ims_conference video 1-1765699908 off
[] 1-1765699908 []
```

record

[][][][][]

```
[][] ims_conference record <conf_id> start|stop
```

```
omnitas@server> ims_conference record 1-1765699908 start
[] 1-1765699908 []
```

```
omnitas@server> ims_conference record 1-1765699908 stop
[] 1-1765699908 []
```

announce

[][][][][][][]

```
[][] ims_conference announce <conf_id> <message>
```

```
omnitas@server> ims_conference announce 1-1765699908 "[][][] 5 []"
[]
[][][] 1-1765699908
```

subscribers

info

ims_conference subscribers <conf_id>

```
omnitas@server> ims_conference subscribers 1-1765699908
1-1765699908
- sip:1235;phone-
context=ims.mnc380.mcc313.3gppnetwork.org@ims.mnc380.mcc313.3gppnetwo
- 19078720151
```

- 0:
- 1:
- 2:
- 3:

- 0:
- 1:
- 2:
- 3:
- 4:
- 5:

- 0:
- 1:

□□

□□□□□□

□□□ □□□□□□□□□□◆◆□□□□□□□□

□□□

1. □□□□□□□□ (/conference)
2. □□□□□□□□□□□□□□□□
3. □□□□□□□□□□□□□□
4. □□□□□□□□□□□□

CLI □□□□□

```
omnitas@server> ims_conference stats
omnitas@server> ims_conference list
```

□□□□□□

□□□ □□□□□□□□□□□□

□□□

1. □□□□□□□□ ID
2. □□ `ims_conference info <conf_id>` □□□□□□
3. □□□□□□□□□□ (□□: □)
4. □□□□□□□□□□□□□□
5. □□□□□□□□□□□□□□□□
6. □□ OmniTAS □□□□□ SIP □□□□□□□□

□□□□□

- □□□□□□ `ims_conference unlock <conf_id>`
- □□□□□□□□□□ default_max_participants □□
- □□□□□□□□ SIP □□□□□□□□□□

如何操作

如何操作

如何

1. 如何
2. 如何

```
ims_conference video <conf_id> off
```

3. 如何
4. 如何

如何操作

如何

如何

1. 如何 ID 如何 UUID
2. 如何

```
ims_conference remove <conf_id> <participant_uuid>
```

3. 如何

```
ims_conference lock <conf_id>
```

4. 如何

```
ims_conference add <conf_id> <sip_uri>
```

如何操作

如何

如何

1. 会議 ID

2. 会議名

```
ims_conference record <conf_id> start
```

3. 会議情報を取得する `info` 操作

4. 会議を終了

```
ims_conference record <conf_id> stop
```

5. OmniTAS による会議の開始

OmniTAS による会議の開始

1. 会議 ID を取得

2. 会議名

1. 会議 ID を取得

```
ims_conference announce <conf_id> "会議名"
```

2. 会議 ID を取得

3. 会議を終了

```
ims_conference destroy <conf_id>
```

4. 会議 ID を取得

IMS による会議の開始

1. 会議 ID を取得

1. SIP INVITE の URI を取得

2. IMS による会議の開始

3. 会議 ID を取得

4. 電話番号 ID の URI
5. 電話番号のフォーマット
6. 電話番号のフォーマットとダイヤル可能な電話番号
7. 電話番号 URI のフォーマット
8. 電話番号のフォーマットと URI の例

電話番号

電話番号 (例: 1)

- 電話番号/区別番号
- 電話番号のフォーマット
- 電話番号のフォーマット
- 電話番号

電話番号 (例: 0)

- 電話番号/区別番号
- 電話番号
- 電話番号/電話番号
- 電話番号

3GPP 電話番号

IMS 電話番号のフォーマット 3GPP 電話番号

- **TS 24.147** 電話番号 IP 電話番号 (IM) 電話番号 (CN) 電話番号
- **RFC 4579** 電話番号 (SIP) 電話番号 - 電話番号
- **RFC 4575** 電話番号 (SIP) 電話番号
- **RFC 5239** 電話番号

電話番号

- **P-CSCF** 電話番号 UE 電話番号 SIP 電話番号
- **S-CSCF** 電話番号
- **OmniTAS** 電話番号

- **HSS**□□□□□□□□□□□□□□□□

□□

□□□□□□□□□□ OmniTAS □□□□□□□□

□□□□□

- `domain`□□□□□□□□□□
- `factory_uri`□□□□□□□□□□ SIP URI
- `mnc_mcc`□□□□□□□□□□
- `access_network`□□□□□□□□□□
- `default_max_participants`□□□□□□□□□□□□□□□□
- `allow_anonymous`□□□□□□□□□□□□
- `video_by_default`□□□□□□□□□□□□□□
- `recording_enabled`□□□□□□□□□□□□
- `announce_join`□□□□□□□□□□□□□□□□
- `announce_leave`□□□□□□□□□□□□□□□□
- `announce_count`□□□□□□□□□□□□

□□□□□

□□□□□

- □□□□□□□□□□□□□□□□□□□□
- □□□□□□□□□□□□□□□□□□□□
- □□□□□□□□□□□□□□□□□□□□ CPU/□□
- □□□□□□□□□□□□□□□□□□□□

□□□□

- □□□□ URI □□□□□
- □□□□□□□□□□□□□□□□□□□□

- 000000000000
- 0000000000
- 000000000000

0000

- 000000000000
- 000000/000
- 000000000000
- 0000000000
- 0000000000

0000000000 000 [metrics.md](#) 0000

- RTP/RTCP 0000000000 9093
- 00000000000000 9090
- 000 Erlang VM 000000 8080
- Prometheus 0000

0000

- 00 OmniTAS 0000000000000000
- 000000000000
- 0000000000000000
- 00 Omnitouch 00000000 ID 0000

0000

000000IMS000000000000Prometheus000

00

- 0000
- 00 9090 - 0000
 - 00000000
 - 0000000
 - 0000
 - 000000000
 - 0000000
 - 0000000
 - 00000
 - Sofia00000
 - 00000000
- 00 8080 - TAS0000
 - 0000000
 - Diameter00000
 - 0000000
 - 00000000OCS000
 - 0000000000
 - 00000000
 - 0000000
 - 0000000
 - Erlang Mnesia00000
 - Erlang VM00000
 - Erlang VM00000
 - Erlang VM00000
 - Erlang VM00000000MSACC
 - Erlang VM0000

- 9093 - RTP/RTCP
- RTP -
- RTP -
- RTP -
- RTP -
- RTCP
- Go
-
- Prometheus HTTP
-
-
-
-
- Grafana
-
-
-
-

Table

Port	Path	Service	Link
9090	/metrics		9090 →
8080	/metrics	TAS, Diameter, HLR, OCS, Erlang VM	8080 →
9093	/esl? module=default	RTP/RTCP	9093 →

9090 -

freeswitch_bridged_calls	9090	
freeswitch_detailed_bridged_calls	9090	
freeswitch_current_calls	9090	
freeswitch_detailed_calls	9090	
freeswitch_current_channels	9090	
freeswitch_current_sessions	9090	
freeswitch_current_sessions_peak	9090	
freeswitch_current_sessions_peak_last_5min	9090	
freeswitch_sessions_total	9090	
freeswitch_current_sps	9090	
freeswitch_current_sps_peak	9090	
freeswitch_current_sps_peak_last_5min	9090	
freeswitch_max_sessions	9090	
freeswitch_max_sps	9090	

配置参数

配置项	类型	描述
<code>freeswitch_current_idle_cpu</code>	9090	当前CPU空闲百分比
<code>freeswitch_min_idle_cpu</code>	9090	最低CPU空闲百分比
<code>freeswitch_uptime_seconds</code>	9090	运行时间(秒)
<code>freeswitch_time_synced</code>	9090	时间同步状态 1=已同步 0=未同步

内存

配置项	类型	描述
<code>freeswitch_memory_arena</code>	9090	malloc arena大小
<code>freeswitch_memory_ordblks</code>	9090	内存块数
<code>freeswitch_memory_smblocks</code>	9090	内存块数
<code>freeswitch_memory_hblocks</code>	9090	内存块数
<code>freeswitch_memory_hblkhd</code>	9090	内存块数
<code>freeswitch_memory_usmblocks</code>	9090	内存块数
<code>freeswitch_memory_fsmblocks</code>	9090	内存块数
<code>freeswitch_memory_uordblks</code>	9090	内存块数
<code>freeswitch_memory_fordblks</code>	9090	内存块数
<code>freeswitch_memory_keepcost</code>	9090	内存块数

Codec

Codec	Port	Options
freeswitch_codec_status	9090	key name type=1

Codec List

- G.711 alaw/ulaw
- PROXY PASS-THROUGH
- PROXY VIDEO PASS-THROUGH
- RAW Signed Linear (16 bit)
- Speex
- VP8/VP9 Video
- AMR variants
- B64
- G.723.1, G.729, G.722, G.726 variants
- OPUS
- MP3
- ADPCM, GSM, LPC-10

Endpoint

Endpoint	Port	Options
freeswitch_endpoint_status	9090	key name type=1

Endpoint List

- error, group, pickup, user (mod_dptools)
- loopback, null (mod_loopback)
- rtc (mod_rtc)

- rtp, sofia (mod_sofia)
- modem (mod_spandsp)

配置

配置项	值	说明
freeswitch_load_module	9090	加载模块1=加载0=加载模块

模块

- mod_sofia (SIP)
- mod_conference, mod_conference_ims
- mod_opus, mod_g729, mod_amr, ...
- mod_event_socket
- mod_dptools
- mod_python3
- mod_rtc
- ...

注册

配置项	值	说明
freeswitch_registrations	9090	注册
freeswitch_registration_details	9090	注册详情: expires, hostname, network_ip, network_port, network_proto, realm, reg_user, token, url

Sofia

名称	端口	描述
freeswitch_sofia_gateway_status	9090	返回上下文、名称、配置文件、代理、方案、状态 (UP/DOWN)
freeswitch_sofia_gateway_call_in	9090	接收呼叫
freeswitch_sofia_gateway_call_out	9090	发起呼叫
freeswitch_sofia_gateway_failed_call_in	9090	接收失败的呼叫
freeswitch_sofia_gateway_failed_call_out	9090	发起失败的呼叫
freeswitch_sofia_gateway_ping	9090	接收 ping 请求，支持 Unix 套接字
freeswitch_sofia_gateway_pingtime	9090	返回 ping 响应时间
freeswitch_sofia_gateway_pingfreq	9090	ping 频率
freeswitch_sofia_gateway_pingcount	9090	ping 计数
freeswitch_sofia_gateway_pingmin	9090	返回 ping 最小值
freeswitch_sofia_gateway_pingmax	9090	返回 ping 最大值

Diameter

名前	ポート	説明
diameter_peer_state	8080	Diameterピアの状態 1=0=ピアの状態 peer_host, peer_realm, application
diameter_requests_total	8080	Diameterリクエストの総数
diameter_responses_total	8080	Diameterレスポンスの総数
diameter_response_duration_milliseconds	8080	Diameterレスポンスの総時間

○○○○○○

○○○○	○○	○○
hlr_lookups_total	8080	HLR○○○○○○○○○○
hlr_data_duration_milliseconds	8080	HLR○○○○○○○○○○○○○○○○ ○○
subscriber_data_lookups_total	8080	○○○○○○○○○○○○○○○○
subscriber_data_duration_milliseconds	8080	Sh○○○○○○○○○○○○○○○○○○ ○○○○
ss7_map_operations_total	8080	SS7 MAP○○○○○○○○○○
ss7_map_http_duration_milliseconds	8080	SS7 MAP HTTP○○○○○○○ ○○○○○○○○○○
tracked_registrations	8080	○○○○SIP○○○○

○○○○○○○○**OCS**○○○○

○○○○	○○	○○
ocs_authorization_attempts_total	8080	OCS○○○○○○○○○○○○○○
ocs_authorization_duration_milliseconds	8080	OCS○○○○○○○○○○○○○○○○ ○○
online_charging_events_total	8080	○○○○○○○○○○○○○○○○
authorization_decisions_total	8080	○○○○○○○○○○○○○○

○○○○○○○○○○

○○○○	○○	○○
http_requests_total	8080	HTTP○○○○○○○○ ○○endpoint, status_code ○○○○
http_dialplan_request_duration_milliseconds	8080	HTTP○○○○○○○○ ○○○○○○○○○○ ○○
dialplan_module_duration_milliseconds	8080	○○○○○○○○○○○○ ○○○○○○○○○○ ○○
freeswitch_variable_set_duration_milliseconds	8080	○○○○○○○○○○○○ ○○○○○○○○

○○○○○○○○

○○○○	○○	○○
event_socket_connected	8080	○○○○○○○○○○1=○○○○0=○○ ○○○○○○connection_type
event_socket_reconnections_total	8080	○○○○○○○○○○○○○○○○○○○○ ○○connection_type, result
event_socket_commands_total	8080	○○○○○○○○○○○○○○○○○○○○ ○○command_type, result
event_socket_command_timeouts_total	8080	○○○○○○○○○○○○○○○○○○○○ ○○command_type

□□□□□□□□

- uuid_setvar, uuid_dump, uuid_kill, uuid_transfer
- uuid_set_media_stats
- sched_hangup, sched_transfer
- vm_boxcount
- status, echo, show, sofia

□□□□

- success: □□□□□□
- timeout: □□□□□□□□
- error: □□□□□□□□

□□□□□□□□

□□□□	□□	□□
feature_invocations_total	8080	TAS□□□□□□□□□□□□□□□□□□□□ feature, call_type, result
feature_data_source_total	8080	□□□□□□□□□□□□□□□□□□□□□□□□ feature, source

□□□□



- call_forward_all - □□□□□□□□
- call_forward_not_reachable - □□□□□□□□□□□□□□
- call_forward_no_reply - □□□□□□□□
- call_barring - □□OCS□□□□□□□□□□□□□□
- cli_withheld - CLI□□/□□

□□□□□ □mo, mt

□□□□ □sh_interface, hlr, config_fallback

□□□□ □success, error, skipped

□□□□□□

□□□□	□□	□□
sms_trigger_attempts_total	8080	□□□□□□□□□□□□□□□□□□□□ trigger_type, result
sms_trigger_errors_total	8080	□□□□□□□□□□   □□□□□□□□□□ trigger_type, error_stage
smsc_requests_total	8080	SMSC HTTP□□□□□□□□□□□□□□□□□□□□ message_type, result

□□□□□ voicemail_deposit, voicemail_clear

□□□□□ vm_boxcount, template_render, smsc_request

□□□□□ notification, mwi

□□□□□ success, error

Erlang Mnesia

名前	サイズ	説明
<code>erlang_mnesia_held_locks</code>	8080	保持中のロック
<code>erlang_mnesia_lock_queue</code>	8080	ロック待ちキュー
<code>erlang_mnesia_transaction_participants</code>	8080	トランザクション参加者
<code>erlang_mnesia_transaction_coordinators</code>	8080	トランザクション調整者
<code>erlang_mnesia_failed_transactions</code>	8080	失敗したトランザクションのリスト
<code>erlang_mnesia_committed_transactions</code>	8080	コミットされたトランザクションのリスト
<code>erlang_mnesia_logged_transactions</code>	8080	ログされたトランザクションのリスト
<code>erlang_mnesia_restarted_transactions</code>	8080	再実行されたトランザクションのリスト
<code>erlang_mnesia_memory_usage_bytes</code>	8080	Mnesia全体のメモリ使用量 (バイト)
<code>erlang_mnesia_tablewise_memory_usage_bytes</code>	8080	Mnesia各テーブルのメモリ使用量 (バイト)
<code>erlang_mnesia_tablewise_size</code>	8080	各テーブルのサイズ (バイト)

Erlang VM

名前	単位	説明
<code>erlang_vm_memory_atom_bytes_total</code>	8080	Atomのメモリ使用量 [used/free]
<code>erlang_vm_memory_bytes_total</code>	8080	VMのメモリ使用量 [system/processes]
<code>erlang_vm_memory_dets_tables</code>	8080	DETSテーブルの数
<code>erlang_vm_memory_ets_tables</code>	8080	ETSテーブルの数
<code>erlang_vm_memory_processes_bytes_total</code>	8080	プロセスのメモリ使用量 [used/free]
<code>erlang_vm_memory_system_bytes_total</code>	8080	システム領域のメモリ使用量 [atom/binary/code/ets/]

Erlang VM

VM	VM	VM
erlang_vm_statistics_bytes_output_total	8080	VM VM VM VM VM
erlang_vm_statistics_bytes_received_total	8080	VM VM VM VM VM
erlang_vm_statistics_context_switches	8080	VM VM VM VM VM
erlang_vm_statistics_dirty_cpu_run_queue_length	8080	VM CPU VM VM VM
erlang_vm_statistics_dirty_io_run_queue_length	8080	VM IO VM VM VM
erlang_vm_statistics_garbage_collection_number_of_gcs	8080	VM VM

名称	单位	类型
		计数 计数
<code>erlang_vm_statistics_garbage_collection_bytes_reclaimed</code>	8080	GC 计数 计数 计数 计数
<code>erlang_vm_statistics_garbage_collection_words_reclaimed</code>	8080	GC 计数 计数 计数 计数
<code>erlang_vm_statistics_reductions_total</code>	8080	计数 计数 计数
<code>erlang_vm_statistics_run_queues_length</code>	8080	计数 计数 计数
<code>erlang_vm_statistics_runtime_milliseconds</code>	8080	计数 计数 计数 计数 计数 计数
<code>erlang_vm_statistics_wallclock_time_milliseconds</code>	8080	计数 计数 计数 计数

Erlang VM

名前	デフォルト値	説明
<code>erlang_vm_dirty_cpu_schedulers</code>	8080	CPUスケジューラ
<code>erlang_vm_dirty_cpu_schedulers_online</code>	8080	オンラインCPUスケジューラ
<code>erlang_vm_dirty_io_schedulers</code>	8080	I/Oスケジューラ
<code>erlang_vm_ets_limit</code>	8080	ETSテーブルの最大数
<code>erlang_vm_logical_processors</code>	8080	論理的プロセッサの数
<code>erlang_vm_logical_processors_available</code>	8080	利用可能な論理的プロセッサの数
<code>erlang_vm_logical_processors_online</code>	8080	オンライン論理的プロセッサの数
<code>erlang_vm_port_count</code>	8080	ポートの数
<code>erlang_vm_port_limit</code>	8080	ポートの最大数
<code>erlang_vm_process_count</code>	8080	プロセスの数
<code>erlang_vm_process_limit</code>	8080	プロセスの最大数
<code>erlang_vm_schedulers</code>	8080	スケジューラ
<code>erlang_vm_schedulers_online</code>	8080	オンラインスケジューラ
<code>erlang_vm_smp_support</code>	8080	SMPサポート (1:サポートあり, 0:サポートなし)
<code>erlang_vm_threads</code>	8080	スレッドの数 (0:無制限)
<code>erlang_vm_thread_pool_size</code>	8080	スレッドプールサイズ

名前	値	説明
<code>erlang_vm_time_correction</code>	8080	1から0までの範囲
<code>erlang_vm_wordsize_bytes</code>	8080	Erlangのワードサイズ
<code>erlang_vm_atom_count</code>	8080	アトム数
<code>erlang_vm_atom_limit</code>	8080	アトム制限

Erlang VMのMSAC

型名, id

項目名	単位	説明
erlang_vm_msacc_aux_seconds_total	8080	補助的な処理に消費された時間
erlang_vm_msacc_check_io_seconds_total	8080	入出力チェックに消費された時間
erlang_vm_msacc_emulator_seconds_total	8080	Erlangの仮想マシンに消費された時間
erlang_vm_msacc_gc_seconds_total	8080	ガベージコレクションに消費された時間
erlang_vm_msacc_other_seconds_total	8080	その他の処理に消費された時間
erlang_vm_msacc_port_seconds_total	8080	ポート操作に消費された時間
erlang_vm_msacc_sleep_seconds_total	8080	スリープに消費された時間
erlang_vm_msacc_alloc_seconds_total	8080	メモリ割り当てに消費された時間
erlang_vm_msacc_bif_seconds_total	8080	BIFsの実行に消費された時間
erlang_vm_msacc_busy_wait_seconds_total	8080	バジーウェイトに消費された時間
erlang_vm_msacc_ets_seconds_total	8080	ETSとBIFsの操作に消費された時間
erlang_vm_msacc_gc_full_seconds_total	8080	フルGCに消費された時間
erlang_vm_msacc_nif_seconds_total	8080	NIFsの実行に消費された時間
erlang_vm_msacc_send_seconds_total	8080	送信操作に消費された時間
erlang_vm_msacc_timers_seconds_total	8080	タイマー操作に消費された時間

Erlang VM

alloc, instance_no, kind, usage

name	pid	usage
erlang_vm_allocators	8080	carriers_size blocks_size erts_alloc(3)

temp_alloc, sl_alloc, std_alloc, ll_alloc, eheap_alloc, ets_alloc, fix_alloc, literal_alloc, binary_alloc, driver_alloc

↑

9093 - RTP

RTP/RTCP

name	pid	usage
freeswitch_info	9093	version
freeswitch_up	9093	1=0=
freeswitch_stack_bytes	9093	
freeswitch_session_total	9093	
freeswitch_session_active	9093	
freeswitch_session_limit	9093	
rtp_channel_info	9093	RTP

RTP -

項目名	値	単位
rtp_audio_in_raw_bytes_total	9093	バイト
rtp_audio_out_raw_bytes_total	9093	バイト
rtp_audio_in_media_bytes_total	9093	バイト
rtp_audio_out_media_bytes_total	9093	バイト

RTPパケット - パケット数

項目名	値	単位
rtp_audio_in_packets_total	9093	パケット
rtp_audio_out_packets_total	9093	パケット
rtp_audio_in_media_packets_total	9093	パケット
rtp_audio_out_media_packets_total	9093	パケット
rtp_audio_in_skip_packets_total	9093	パケット
rtp_audio_out_skip_packets_total	9093	パケット

RTPパケット - パケット数

項目名	単位	説明
rtp_audio_in_jitter_packets_total	9093	合計のジッタパケット数
rtp_audio_in_dtmf_packets_total	9093	合計のDTMFパケット数
rtp_audio_out_dtmf_packets_total	9093	合計のDTMFパケット数
rtp_audio_in_cng_packets_total	9093	合計のCNGパケット数
rtp_audio_out_cng_packets_total	9093	合計のCNGパケット数
rtp_audio_in_flush_packets_total	9093	合計のフラッシュパケット数

RTP統計 - 音声品質

項目名	単位	説明
rtp_audio_in_jitter_buffer_bytes_max	9093	最大のジッタバッファバイト数
rtp_audio_in_jitter_seconds_min	9093	最小のジッタ秒数
rtp_audio_in_jitter_seconds_max	9093	最大のジッタ秒数
rtp_audio_in_jitter_loss_rate	9093	ジッタによるパケット損失率
rtp_audio_in_jitter_burst_rate	9093	ジッタによるパケットバースト率
rtp_audio_in_mean_interval_seconds	9093	平均パケット間隔秒数
rtp_audio_in_flaw_total	9093	合計の音声品質劣化パケット数
rtp_audio_in_quality_percent	9093	音声品質劣化率 (0-100%)
rtp_audio_in_quality_mos	9093	平均音声品質 (1-5) (5は最高)

RTCP

名前	値	単位
rtcp_audio_bytes_total	9093	RTCP
rtcp_audio_packets_total	9093	RTCP

Go 變數

變數名稱	類型	說明
<code>go_goroutines</code>	9090	目前正在執行的 goroutine 數量
<code>go_threads</code>	9090	目前正在執行的 thread 數量
<code>go_info</code>	9090	Go 語言版本資訊
<code>go_gc_duration_seconds</code>	9090	垃圾回收 (GC) 的執行時間
<code>go_memstats_alloc_bytes</code>	9090	目前堆疊中已分配的記憶體總量
<code>go_memstats_alloc_bytes_total</code>	9090	目前堆疊中已分配的記憶體總量 (包含已釋放)
<code>go_memstats_heap_alloc_bytes</code>	9090	目前堆疊中已分配的堆疊記憶體總量
<code>go_memstats_heap_idle_bytes</code>	9090	目前堆疊中已分配的堆疊記憶體 (閒置)
<code>go_memstats_heap_inuse_bytes</code>	9090	目前堆疊中已分配的堆疊記憶體 (使用中)
<code>go_memstats_heap_objects</code>	9090	目前堆疊中已分配的堆疊物件數量
<code>go_memstats_heap_released_bytes</code>	9090	目前堆疊中已分配的堆疊記憶體 (已釋放)
<code>go_memstats_heap_sys_bytes</code>	9090	目前堆疊中已分配的堆疊系統記憶體總量
<code>go_memstats_sys_bytes</code>	9090	目前堆疊中已分配的系統記憶體總量

进程

名称	单位	描述
<code>process_cpu_seconds_total</code>	9090	进程CPU时间总和
<code>process_max_fds</code>	9090	进程最大文件描述符数
<code>process_open_fds</code>	9090	进程当前打开的文件描述符数
<code>process_resident_memory_bytes</code>	9090	进程的常驻内存大小
<code>process_virtual_memory_bytes</code>	9090	进程的虚拟内存大小
<code>process_virtual_memory_max_bytes</code>	9090	进程的虚拟内存最大值
<code>process_start_time_seconds</code>	9090	Unix纪元时间戳，表示进程启动时间

Prometheus HTTP

名称	单位	描述
<code>promhttp_metric_handler_requests_in_flight</code>	9090	当前正在处理的HTTP请求数
<code>promhttp_metric_handler_requests_total</code>	9090	HTTP请求总数

↑ 进程

指标

- gauge**: `current_calls`, `cpu_idle`
- counter**: `sessions_total`, `failed_scrapes`

- **summary:** `gc_duration_seconds`
-

↑ `gc`

`gc`

Configure Prometheus

```
scrape_configs:  
  - job_name: 'ims_as_system'  
    static_configs:  
      - targets: ['localhost:9090']  
  
  - job_name: 'ims_as_engine'  
    static_configs:  
      - targets: ['localhost:8080']  
    metrics_path: '/metrics'  
  
  - job_name: 'ims_as_media'  
    static_configs:  
      - targets: ['localhost:9093']  
    metrics_path: '/esl'  
    params:  
      module: ['default']
```

↑ `gc`

`gc`

Configure

- `9090`
- `9093`
- `TAS 8080`

□□□□

□□□□□

```
freeswitch_current_calls
```

□□□□□

```
freeswitch_sofia_gateway_status{status="UP"}
```

□□□□□**ping**□□□

```
avg(freeswitch_sofia_gateway_pingtime)
```

□□□□□□□

```
freeswitch_current_sps
```

□□□□□□□

```
freeswitch_memory_uordblks
```

□□□□□□□

□□□□□**MOS**□□□□

```
rtp_audio_in_quality_mos
```

□□□□□□□□

```
rtp_audio_in_quality_percent
```

□□□□

```
rate(rtp_audio_in_jitter_packets_total[5m])
```

□□□□□□□

```
rtp_audio_in_jitter_loss_rate
```

□□□□□

```
avg(rtp_audio_in_jitter_seconds_max -  
rtp_audio_in_jitter_seconds_min)
```

RTP□□□□□□□

```
rate(rtp_audio_in_media_bytes_total[1m]) * 8
```

□□□□□□□□□□

```
increase(rtp_audio_in_flaw_total[5m])
```

TAS□□□□

□□□□□□□□□□

```
active_calls
```

Diameter□□□□□□□

```
diameter_peer_state{application="sh"}
```

□□□□□□□□

```
rate(call_attempts_total[5m])
```

HLR□□□□□95□□□□□

```
histogram_quantile(0.95, hlr_data_duration_milliseconds)
```

OCS□□□□□

```
histogram_quantile(0.99, ocs_authorization_duration_milliseconds)
```

□□□□□□□□□□

```
rate(subscriber_data_lookups_total[5m])
```

Diameter□□□□□□

```
rate(diameter_responses_total[5m]) /  
rate(diameter_requests_total[5m])
```

□□□□□□□□□□

```
event_socket_connected
```

Mnesia□□□□□

```
rate(erlang_mnesia_committed_transactions[5m])
```

Mnesia□□□□□□□

```
rate(erlang_mnesia_failed_transactions[5m])
```

Erlang VM□□□□□

```
erlang_vm_process_count
```

Erlang VM

```
erlang_vm_memory_bytes_total
```

```
rate(erlang_vm_statistics_garbage_collection_number_of_gcs[5m])
```

```
erlang_vm_statistics_run_queues_length
```

ETS

```
erlang_vm_memory_ets_tables
```

HTTP

```
histogram_quantile(0.5,  
http_dialplan_request_duration_milliseconds)
```

↑

Grafana

Prometheus Grafana

- `active_calls`

- `rate(call_attempts_total[5m])`
- `rate(call_rejections_total[5m])`
- `freeswitch_sofia_gateway_status`

Network

- P95 HTTP
- P95 Sh
- P95 HLR
- P95 OCS
- P95 Diameter

Core

- HLR
- OCS
- Diameter

Quality

- `rtp_audio_in_quality_mos`
- `rtp_audio_in_quality_percent`
-
-

Performance

- Erlang VM
- Erlang VM
- ETS
-
-

Security

-

- 0000
- 0000000000
- Mnesia0000

000000

0000000000

```
sum by (call_type) (active_calls)
```

P950000000000

```
histogram_quantile(0.95,
  rate(http_dialplan_request_duration_milliseconds_bucket[5m])
)
```

Diameter0000

```
rate(diameter_responses_total{result="success"}[5m]) /
rate(diameter_requests_total[5m]) * 100
```

0000 - 00**MOS**

```
avg(rtp_audio_in_quality_mos)
```

↑ 0000

00000

00000000000000

0000 - 00000000

```
alert: SystemDown
expr: rate(call_attempts_total[5m]) == 0
for: 2m
labels:
  severity: critical
annotations:
  summary: "TAS - "
  description: "2"
```

Diameter

```
alert: DiameterPeerDown
expr: diameter_peer_state == 0
for: 1m
labels:
  severity: critical
annotations:
  summary: "Diameter{{ $labels.peer_host }}"
  description: "{{ $labels.application }}"
```

```
alert: EventSocketDisconnected
expr: event_socket_connected == 0
for: 30s
labels:
  severity: critical
annotations:
  summary: "{{ $labels.connection_type }}"
  description: ""
```

Diameter

```

alert: HighDiameterLatency
expr: |
    histogram_quantile(0.95,
        rate(diameter_response_duration_milliseconds_bucket[5m])
    ) > 1000
for: 5m
labels:
    severity: high
annotations:
    summary: "Diameter"
    description: "P95{{ $value }}ms"

```

OCS

```

alert: OCSAuthFailures
expr: |
    rate(ocs_authorization_attempts_total{result="no_credit"}[5m]) /
    rate(ocs_authorization_attempts_total[5m]) > 0.1
for: 5m
labels:
    severity: high
annotations:
    summary: "OCS"
    description: "{{ $value | humanizePercentage }}"

```



```

alert: HighCallRejectionRate
expr: |
    rate(call_rejections_total[5m]) /
    rate(call_attempts_total[5m]) > 0.05
for: 5m
labels:
    severity: high
annotations:
    summary: ""5%"
    description: "{{ $value | humanizePercentage }}"

```

##

```
alert: PoorMediaQuality
expr: avg(rtp_audio_in_quality_mos) < 3.5
for: 3m
labels:
  severity: high
annotations:
  summary: "Pöör Media Quality"
  description: "Pöör MOS pöör {{ $value }}"
```

Pöör Pöör

Pöör Pöör

```
alert: HighMemoryUsage
expr: |
  erlang_vm_memory_bytes_total{kind="processes"} /
  (erlang_vm_process_limit * 1000000) > 0.8
for: 10m
labels:
  severity: warning
annotations:
  summary: "Erlang VM Pöör Pöör"
  description: "Pöör Pöör {{ $value | humanizePercentage }}"
```

Pöör Pöör Pöör

```
alert: HighSchedulerRunQueue
expr: erlang_vm_statistics_run_queues_length > 10
for: 5m
labels:
  severity: warning
annotations:
  summary: "Pöör Pöör Pöör Pöör"
  description: "Pöör Pöör Pöör {{ $value }}"
```

Mnesia Pöör Pöör

```
alert: MnesiaTransactionFailures
expr: rate(erlang_mnesia_failed_transactions[5m]) > 1
for: 5m
labels:
  severity: warning
annotations:
  summary: "Mnesia"
  description: "{{ $value }}"
```

↑

- 1.

```
histogram_quantile(0.95,
rate(http_dialplan_request_duration_milliseconds_bucket[5m]))
```

- 2.

```
#
histogram_quantile(0.95,
rate(subscriber_data_duration_milliseconds_bucket[5m]))

# HLR
histogram_quantile(0.95,
rate(hlr_data_duration_milliseconds_bucket[5m]))

# OCS
histogram_quantile(0.95,
rate(ocs_authorization_duration_milliseconds_bucket[5m]))
```

3. Histogram

```
histogram_quantile(0.95,  
  rate(dialplan_module_duration_milliseconds_bucket[5m])  
) by (module)
```

Filter

- Filter HSS, HLR, OCS
- Filter
- Filter
- Filter

Aggregation

Filter

1. Filter

```
sum by (reason) (rate(call_rejections_total[5m]))
```

2. Filter

```
sum by (decision) (rate(authorization_decisions_total[5m]))
```

3. Filter **Diameter**

```
diameter_peer_state
```

4. Filter

```
event_socket_connected
```

□□□□□□

□□□□□

1. □□□□□□

```
rate(call_attempts_total[5m])
active_calls
```

2. □□**Erlang VM**□□□

```
erlang_vm_process_count
erlang_vm_statistics_run_queues_length
erlang_vm_memory_bytes_total
```

3. □□□□□□□

```
rate(erlang_vm_statistics_garbage_collection_number_of_gcs[5m])
```

□□□□□□□□

□□□□□

1. □□**MOS**□□□

```
rtp_audio_in_quality_mos
rtp_audio_in_quality_percent
```

2. □□□□□

```
rtp_audio_in_jitter_seconds_max
rtp_audio_in_jitter_loss_rate
```

3. □□□□□□□□

```
rtp_audio_in_skip_packets_total
rtp_audio_in_flaw_total
```

4. 吞吐量

```
rate(rtp_audio_in_media_bytes_total[1m]) * 8
```

↑ 吞吐量

吞吐量

吞吐量

吞吐量P95

- HTTP吞吐量200-500ms
- 吞吐量Sh吞吐量50-150ms
- HLR吞吐量100-300ms
- OCS吞吐量100-250ms
- Diameter吞吐量50-200ms
- 吞吐量吞吐量10-50ms

吞吐量

- 吞吐量>95%
- 吞吐量吞吐量>99%
- HLR吞吐量>98%
- OCS吞吐量>99%吞吐量
- Diameter吞吐量吞吐量>99.9%

吞吐量

- MOS吞吐量>4.0

- 呼叫成功率 > 80%
- 呼叫延迟 < 30ms
- 呼叫失败率 < 1%

呼叫质量

- Erlang 利用率 < 50% 呼叫
- Erlang 利用率 < 70% 呼叫
- 呼叫阻塞率 < 5
- ETS 呼叫 < 1000

呼叫速率

呼叫速率限制

- 呼叫速率 500-1000 呼叫/秒
- 呼叫速率 20-50 CPS
- 呼叫速率 10,000-50,000

呼叫速率限制

- 呼叫成功率 70% 呼叫
- Erlang 利用率 < 70% 呼叫
- P95 呼叫
- 呼叫速率限制 10

↑ 呼叫

呼叫质量

呼叫速率

1. 呼叫速率限制
 - 呼叫速率限制 10

- 時間系列データの取得
- 時間系列データのKPIの計算

2. データの取得

- データソースの指定
- データの取得
- データのフィルタリング

3. データの加工

- データの5分間隔
- データの15分間隔1時間
- データの平均/標準偏差

4. データの可視化

- データの可視化
- データの可視化
- データの可視化

まとめ

1. データの取得

```
groups:
  - name: ims_as_aggregations
    interval: 30s
    rules:
      - record: job:call_attempts:rate5m
        expr: rate(call_attempts_total[5m])

      - record: job:dialplan_latency:p95
        expr: histogram_quantile(0.95,
rate(http_dialplan_request_duration_milliseconds_bucket[5m]))
```

2. データの加工

3. データの可視化

- `count by` [5m]
- `count by` [1h]
- `count by` [1d]

□□□□

□□□□□□ Prometheus □□□□□

```
# □□□□□□
count by (__name__) ({__name__=~".+"})
```

□□□□□□

- □□□□□□□□□□□□□□□□ ID
- □□□□□
- □□1000□□□□□□□□

□□□□□

- □□□□□□□□□□□□□□□□
- □□□□□□□□□□□□□□
- □□□□□□□□□□□□

↑ □□□□

☐☐	☐☐/☐☐	E.164 ☐☐	☐☐☐☐	☐☐	IDD	☐☐
:AC	☐☐☐☐	247	5	☐	00	
:AD	☐☐☐	376	6-9	☐	00	
:AE	☐☐☐	971	9	0	00	
:AF	☐☐☐	93	9	0	00	
:AG	☐☐☐☐☐☐☐☐	1	10	☐	011	NANP☐☐☐☐☐☐☐☐
:AI	☐☐☐	1	10	☐	011	NANP☐☐☐☐☐☐☐☐
:AL	☐☐☐☐☐	355	9	0	00	
:AM	☐☐☐☐	374	8	0	00	
:AO	☐☐☐	244	9	☐	00	
:AR	☐☐☐	54	10	0	00	
:AS	☐☐☐☐☐	1	10	☐	011	NANP☐☐☐☐☐☐☐☐
:AT	☐☐☐	43	10-13	0	00	
:AU	☐☐☐☐	61	9	0	0011	
:AW	☐☐☐	297	7	☐	00	
:AX	☐☐☐☐	358	9-10	0	00	☐☐☐☐☐
:AZ	☐☐☐☐	994	9	0	00	
:BA	☐☐☐☐☐☐☐☐☐☐☐☐	387	8	0	00	
:BB	☐☐☐☐	1	10	☐	011	NANP☐☐☐☐☐☐☐☐

☐☐	☐☐/☐☐	E.164 ☐☐	☐☐☐☐	☐☐	IDD	☐☐
:BD	☐☐☐☐	880	10	0	00	
:BE	☐☐☐	32	8-9	0	00	
:BF	☐☐☐☐☐☐	226	8	☐	00	
:BG	☐☐☐☐	359	9	0	00	
:BH	☐☐	973	8	☐	00	
:BI	☐☐☐	257	8	☐	00	
:BJ	☐☐	229	8	☐	00	
:BL	☐☐☐☐☐☐	590	9	0	00	
:BM	☐☐☐	1	10	☐	011	NANP☐☐☐☐☐☐
:BN	☐☐	673	7	☐	00	
:BO	☐☐☐☐	591	8	☐	00	
:BQ	☐☐☐/☐☐☐☐☐☐/☐☐	599	7	☐	00	
:BR	☐☐	55	10-11	0	00	
:BS	☐☐☐	1	10	☐	011	NANP☐☐☐☐☐☐
:BT	☐☐	975	8	☐	00	
:BV	☐☐☐	47	8	☐	00	☐☐☐☐☐
:BW	☐☐☐☐	267	8	☐	00	
:BY	☐☐☐☐	375	9	8	810	

☐☐	☐☐/☐☐	E.164 ☐☐	☐☐☐☐	☐☐	IDD	☐☐
:BZ	☐☐☐	501	7	☐	00	
:CA	☐☐☐	1	10	☐	011	NANP☐☐☐☐☐☐
:CC	☐☐☐☐☐	61	9	0	0011	☐☐☐☐☐☐☐
:CD	☐☐☐☐☐☐☐	243	9	0	00	
:CF	☐☐☐☐☐	236	8	☐	00	
:CG	☐☐☐☐☐	242	9	☐	00	
:CH	☐☐	41	9	0	00	
:CI	☐☐☐☐	225	10	☐	00	
:CK	☐☐☐☐	682	5	☐	00	
:CL	☐☐	56	9	0	00	
:CM	☐☐☐	237	9	☐	00	
:CN	☐☐	86	11	☐	00	
:CO	☐☐☐☐	57	10	0	00	
:CR	☐☐☐☐☐	506	8	☐	00	
:CU	☐☐	53	8	0	119	
:CV	☐☐☐	238	7	☐	00	
:CW	☐☐☐	599	7-8	☐	00	
:CX	☐☐☐	61	9	0	0011	☐☐☐☐☐☐☐

☐☐	☐☐/☐☐	E.164 ☐☐	☐☐☐☐	☐☐	IDD	☐☐
:CY	☐☐☐☐	357	8	☐	00	
:CZ	☐☐☐☐☐☐	420	9	☐	00	
:DE	☐☐	49	10-12	0	00	
:DJ	☐☐☐	253	8	☐	00	
:DK	☐☐	45	8	☐	00	
:DM	☐☐☐☐	1	10	📞📞📞	011	NANP☐☐☐☐☐☐
:DO	☐☐☐☐☐☐☐☐	1	10	☐	011	NANP☐☐☐☐☐☐
:DZ	☐☐☐☐☐☐	213	9	0	00	
:EC	☐☐☐☐	593	9	0	00	
:EE	☐☐☐☐	372	7-8	☐	00	
:EG	☐☐	20	10	0	00	
:EH	☐☐☐☐	212	9	0	00	☐☐☐☐☐☐
:ER	☐☐☐☐☐☐	291	7	0	00	
:ES	☐☐☐	34	9	☐	00	
:ET	☐☐☐☐☐☐	251	9	0	00	
:FI	☐☐	358	9-10	0	00	
:FJ	☐☐	679	7	☐	00	
:FK	☐☐☐☐☐☐	500	5	☐	00	

☐☐	☐☐/☐☐	E.164 ☐☐	☐☐☐☐	☐☐	IDD	☐☐
:FM	☐☐☐☐☐☐	691	7	☐	011	
:FO	☐☐☐☐	298	6	☐	00	
:FR	☐☐	33	9	0	00	
:GA	☐☐	241	7	☐	00	
:GB	☐☐	44	10	0	00	
:GD	☐☐☐☐	1	10	☐	011	NANP☐☐☐☐☐☐
:GE	☐☐☐☐	995	9	0	00	
:GF	☐☐☐☐☐☐	594	9	0	00	
:GG	☐☐☐☐	44	10	0	00	☐☐☐☐☐☐
:GH	☐☐	233	9	0	00	
:GI	☐☐☐☐	350	8	☐	00	
:GL	☐☐☐☐	299	6	☐	00	
:GM	☐☐☐☐	220	7	☐	00	
:GN	☐☐☐☐	224	9	☐	00	
:GP	☐☐☐☐☐☐	590	9	0	00	
:GQ	☐☐☐☐☐☐	240	9	☐	00	
:GR	☐☐	30	10	☐	00	
:GS	☐☐☐☐☐☐	500	5	☐	00	☐☐☐☐☐☐☐☐

☐☐	☐☐/☐☐	E.164 ☐☐	☐☐☐☐	☐☐	IDD	☐☐
:GT	☐☐☐☐	502	8	☐	00	
:GU	☐☐	1	10	☐	011	NANP☐☐☐☐☐☐
:GW	☐☐☐☐☐☐	245	7	☐	00	
:GY	☐☐☐	592	7	☐	001	
:HK	☐☐	852	8	☐	001	
:HM	☐☐☐☐☐☐☐☐☐☐☐☐	61	9	0	0011	☐☐☐☐☐☐☐☐
:HN	☐☐☐☐	504	8	☐	00	
:HR	☐☐☐☐	385	9	0	00	
:HT	☐☐	509	8	☐	00	
:HU	☐☐☐	36	9	06	00	
:ID	☐☐☐☐☐☐	62	10-12	0	001	
:IE	☐☐☐	353	9	0	00	
:IL	☐☐☐	972	9	0	00	
:IM	☐☐☐	44	10	0	00	☐☐☐☐☐☐
:IN	☐☐	91	10	0	00	
:IO	☐☐☐☐☐☐☐☐	246	7	☐	00	
:IQ	☐☐☐	964	10	0	00	
:IR	☐☐	98	10	0	00	

☐☐	☐☐/☐☐	E.164 ☐☐	☐☐☐☐	☐☐	IDD	☐☐
:IS	☐☐	354	7	☐	00	
:IT	☐☐☐	39	9-10	☐	00	☐☐☐☐☐☐☐☐ 0
:JE	☐☐☐	44	10	0	00	☐☐☐☐☐
:JM	☐☐☐	1	10	☐	011	NANP☐☐☐☐☐☐☐
:JO	☐☐	962	9	0	00	
:JP	☐☐	81	10	0	010	
:KE	☐☐☐	254	9	0	000	
:KG	☐☐☐☐☐☐	996	9	0	00	
:KH	☐☐☐	855	8-9	0	001	
:KI	☐☐☐☐	686	5	☐	00	
:KM	☐☐☐	269	7	☐	00	
:KN	☐☐☐☐☐☐☐	1	10	☐	011	NANP☐☐☐☐☐☐☐
:KP	☐☐	850	10	0	00	
:KR	☐☐	82	9-10	0	001	
:KW	☐☐☐	965	8	☐	00	
:KY	☐☐☐☐	1	10	☐	011	NANP☐☐☐☐☐☐☐
:KZ	☐☐☐☐☐	7	10	8	810	
:LA	☐☐	856	10	0	00	

☐☐	☐☐/☐☐	E.164 ☐☐	☐☐☐☐	☐☐	IDD	☐☐
:LB	☐☐☐	961	8	0	00	
:LC	☐☐☐☐	1	10	☐	011	NANP☐☐☐☐☐☐
:LI	☐☐☐☐☐	423	7	☐	00	
:LK	☐☐☐☐	94	9	0	00	
:LR	☐☐☐☐	231	7-9	☐	00	
:LS	☐☐☐	266	8	☐	00	
:LT	☐☐☐	370	8	8	00	
:LU	☐☐☐	352	9	☐	00	
:LV	☐☐☐☐	371	8	☐	00	
:LY	☐☐☐	218	9	0	00	
:MA	☐☐🇲🇦🇲🇦🇲🇦	212	9	0	00	
:MC	☐☐☐	377	8-9	☐	00	
:MD	☐☐☐☐	373	8	0	00	
:ME	☐☐	382	8	0	00	
:MF	☐☐☐	590	9	0	00	
:MG	☐☐☐☐☐	261	9	0	00	
:MH	☐☐☐☐☐	692	7	☐	011	
:MK	☐☐☐☐	389	8	0	00	

☐☐	☐☐/☐☐	E.164 ☐☐	☐☐☐☐	☐☐	IDD	☐☐
:ML	☐☐	223	8	☐	00	
:MM	☐☐	95	8-10	0	00	
:MN	☐☐	976	8	☐	001	
:MO	☐☐	853	8	☐	00	
:MP	☐☐☐☐☐☐☐☐	1	10	☐	011	NANP☐☐☐☐☐☐☐☐
:MQ	☐☐☐☐	596	9	0	00	
:MR	☐☐☐☐☐	222	8	☐	00	
:MS	☐☐☐☐☐☐	1	10	☐	011	NANP☐☐☐☐☐☐☐☐
:MT	☐☐☐	356	8	☐	00	
:MU	☐☐☐☐	230	8	☐	00	
:MV	☐☐☐☐	960	7	☐	00	
:MW	☐☐☐	265	9	0	00	
:MX	☐☐☐	52	10	☐	00	
:MY	☐☐☐☐	60	9-10	0	00	
:MZ	☐☐☐☐	258	9	☐	00	
:NA	☐☐☐☐	264	9	0	00	
:NC	☐☐☐☐☐☐☐☐	687	6	☐	00	
:NE	☐☐☐	227	8	☐	00	

☐☐	☐☐/☐☐	E.164 ☐☐	☐☐☐☐	☐☐	IDD	☐☐
:NF	☐☐☐☐	672	5-6	☐	00	
:NG	☐☐☐☐	234	10	0	009	
:NI	☐☐☐☐	505	8	☐	00	
:NL	☐☐	31	9	0	00	
:NO	☐☐	47	8	☐	00	
:NP	☐☐☐	977	10	0	00	
:NR	☐☐	674	7	☐	00	
:NU	☐☐	683	4	☐	00	
:NZ	☐☐☐	64	8-9	0	00	
:OM	☐☐	968	8	☐	00	
:PA	☐☐☐	507	8	☐	00	
:PE	☐☐	51	9	0	00	
:PF	☐☐☐☐☐☐☐☐	689	8	☐	00	
:PG	☐☐☐☐☐☐☐☐	675	8	☐	05	
:PH	☐☐☐	63	10	0	00	
:PK	☐☐☐☐	92	10	0	00	
:PL	☐☐	48	9	☐	00	
:PM	☐☐☐☐☐☐☐☐	508	6	☐	00	

☐☐	☐☐/☐☐	E.164 ☐☐	☐☐☐☐	☐☐	IDD	☐☐
:PN	☐☐☐☐☐☐	64	8-9	0	00	☐☐☐☐☐☐
:PR	☐☐☐☐	1	10	☐	011	NANP☐☐☐☐☐☐
:PS	☐☐☐☐	970	9	0	00	
:PT	☐☐☐	351	9	☐	00	
:PW	☐☐	680	7	☐	011	
:PY	☐☐☐	595	9	0	00	
:QA	☐☐☐	974	8	☐	00	
:RE	☐☐☐	262	9	0	00	
:RO	☐☐☐☐	40	9	0	00	
:RS	☐☐☐☐	381	9	0	00	
:RU	☐☐☐	7	10	8	810	
:RW	☐☐☐	250	9	0	00	
:SA	☐☐☐☐☐☐	966	9	0	00	
:SB	☐☐☐☐☐☐	677	5-7	☐	00	
:SC	☐☐☐☐	248	7	☐	00	
:SD	☐☐	249	9	0	00	
:SE	☐☐	46	9	0	00	
:SG	☐☐☐☐	65	8	☐	001	

☐☐	☐☐/☐☐	E.164 ☐☐	☐☐☐☐	☐☐	IDD	☐☐
:SH	☐☐☐☐	290	4-5	☐	00	
:SI	☐☐☐☐☐	386	8	0	00	
:SJ	☐☐☐☐☐	47	8	☐	00	☐☐☐☐☐
:SK	☐☐☐☐	421	9	0	00	
:SL	☐☐☐☐	232	8	0	00	
:SM	☐☐☐☐	378	10	☐	00	
:SN	☐☐☐☐	221	9	☐	00	
:SO	☐☐☐	252	8	☐	00	
:SR	☐☐☐	597	7	☐	00	
:SS	☐☐☐	211	9	0	00	
:ST	☐☐☐☐☐☐☐☐☐	239	7	☐	00	
:SV	☐☐☐☐	503	8	☐	00	
:SX	☐☐☐☐☐	1721	7	☐	00	
:SY	☐☐☐	963	9	0	00	
:SZ	☐☐☐☐	268	8	☐	00	
:TC	☐☐☐☐☐☐☐☐☐☐	1	10	☐	011	NANP☐☐☐☐☐☐
:TD	☐☐	235	8	☐	00	
:TG	☐☐	228	8	☐	00	

☐☐	☐☐/☐☐	E.164 ☐☐	☐☐☐☐	☐☐	IDD	☐☐
:TH	☐☐	66	9	0	001	
:TJ	☐☐☐☐☐☐	992	9	☐	810	
:TK	☐☐☐	690	4	☐	00	
:TL	☐☐☐	670	7-8	☐	00	
:TM	☐☐☐☐☐☐	993	8	8	810	
:TN	☐☐☐	216	8	☐	00	
:TO	☐☐	676	5-7	☐	00	
:TR	☐☐☐	90	10	0	00	
:TT	☐☐☐☐☐☐☐☐☐☐	1	10	☐	011	NANP☐☐☐☐☐☐
:TV	☐☐☐	688	5	☐	00	
:TW	☐☐	886	9	0	002	
:TZ	☐☐☐☐	255	9	0	00	
:UA	☐☐☐	380	9	0	00	
:UG	☐☐☐	256	9	0	00	
:US	☐☐	1	10	☐	011	NANP ☐☐☐☐
:UY	☐☐☐	598	8	0	00	
:UZ	☐☐☐☐☐☐☐☐	998	9	☐	810	
:VA	☐☐☐	39	9-10	☐	00	☐☐☐☐☐☐

□□	□□/□□	E.164 □□	□□□□	□□	IDD	□□
:VC	□□□□□□□□□□	1	10	□	011	NANP□□□□□□
:VE	□□□□	58	10	0	00	
:VG	□□□□□□□□	1	10	□	011	NANP□□□□□□
:VI	□□□□□□□□	1	10	□	011	NANP□□□□□□
:VN	□□	84	9-10	0	00	
:VU	□□□□	678	5-7	□	00	
:WF	□□□□□□□□	681	6	□	00	
:WS	□□□□	685	5-7	□	0	
:XK	□□□□	383	8	0	00	
:YE	□□	967	9	0	00	
:YT	□□□□	262	9	0	00	□□□□□□
:ZA	□□	27	9	0	00	
:ZM	□□□□	260	9	0	00	
:ZW	□□□□	263	9	0	00	

□□□□□□

1. CLI □□□□□□

□□□□□□□□ CLI □□□□□□□□

000 *67555123456
 00 1000 *67 → 555123456
 00 2000 → 155512345600000000

2. SIP 0000

000000000000

000 61403123456;npdi;rn=+614000000000
 00 1000 ;npdi;rn=... → 61403123456
 00 2000 → 61403123456

3. 00000000

00000000000 +000000

000 +61 (403) 123-456
 00 1000000 → +61403123456
 00 2000 → 61403123456

00000000000

00	0	00
destination_number	E.164 0 0	0000000000
tas_destination_number	E.164 0 0	0 destination_number 00000000 000000
effective_caller_id_number	E.164 0 0	0000000000MO 000

□□□□□□□□□□

□□□□□□□□□□

```
config :tas, number_translate: %{country_code: :XX} # □□
```

□□□ `{:error, "□□□□□□□□"}` - □□□□□

□□□□□□□□□□

```
□□□ "abc123"□□□□□□□□  
□□ 1□□□□□□□ → "123"  
□□ 2□□□□□□□□□□□□□□  
□□□□□□□□□□□□□□□□□□□□
```

□□□□□ □□□□□□□□ E.164 □□□□□□□□□□

□□□□□□□□

Web UI □□□□□ (`/translate`)□

1. □□□□□□□□□□ `/translate`
2. □□□□□□□□□□□□□□
3. □□□□□□□□□□□□
4. □□□□□□□□ E.164 □□
5. □□□□□□□□□□

□□□□□□□□

- □□□□ → E.164
- □□□□ (ONSN) → E.164
- □□□□ (+CC) → E.164
- □□ CLI □□□□□□ → □□□□□□
- □□□□□□□□□□□□□□□□ → □□□□ E.164

UNALLOCATED_NUMBER

UNALLOCATED_NUMBER "UNALLOCATED_NUMBER"

1. UNALLOCATED_NUMBER

- `/translate` UNALLOCATED_NUMBER
- UNALLOCATED_NUMBER E.164 UNALLOCATED_NUMBER
- UNALLOCATED_NUMBER

2. UNALLOCATED_NUMBER Sh UNALLOCATED_NUMBER

- UNALLOCATED_NUMBER Sh UNALLOCATED_NUMBER
- `/sh_test` UNALLOCATED_NUMBER
- UNALLOCATED_NUMBER MSISDN UNALLOCATED_NUMBER

3. UNALLOCATED_NUMBER

- UNALLOCATED_NUMBER `destination_number` UNALLOCATED_NUMBER
- UNALLOCATED_NUMBER

UNALLOCATED_NUMBER

```
# UNALLOCATED_NUMBER
config :tas, number_translate: %{
  country_code: :AU,
  localAreaCode: "617" # UNALLOCATED_NUMBER
}
```

```
# UNALLOCATED_NUMBER12345678 UNALLOCATED_NUMBER
# UNALLOCATED_NUMBER6161712345678 UNALLOCATED_NUMBER - UNALLOCATED_NUMBER
# UNALLOCATED_NUMBER UNALLOCATED_NUMBER localAreaCode
```

UNALLOCATED_NUMBER

UNALLOCATED_NUMBER

- `+61403123456` UNALLOCATED_NUMBER `61403123456` → UNALLOCATED_NUMBER
- `0403123456` UNALLOCATED_NUMBER country_code UNALLOCATED_NUMBER → UNALLOCATED_NUMBER

MO 与 MT 的区别

MT 区别

- 接收方手机号码
- 接收方 SIP 号码
- 接收方 Sh 号码

MO 区别

- 发送方手机号码
- 发送方 SIP 号码
- 发送方 Sh 号码
- 呼叫记录/CDR

区别

1. 接收方号码

- 接收方 `country_code` 接收方号码
- 接收方号码

2. 发送方号码

- 发送方 `localAreaCode` 接收方号码
- 发送方号码

3. 接收方号码

- 接收方号码
- 接收方 0NSN 号码
- 接收方 +CC 号码
- 接收方号码

4. 接收方号码

- 接收方 "接收方号码" 号码
- 接收方号码

- 00 E.164 0000000000

5. 0000000000

- 0000000000
- 0 /translate 0000000000
- 00000000000000

OmniTAS (OCS) 介紹

OmniTAS 採用 Diameter Ro 協議實現 AVP 與 FreeSWITCH 的集成

目錄

- 介紹
- 協議
- AVP 協議
- 集成
- FreeSWITCH 集成
- Diameter 集成
- 配置
- 測試
- 部署
 - FreeSWITCH 部署
 - AVP 部署

簡介

OmniTAS 基於 3GPP TS 32.299 實現 Diameter Ro 協議，OCS 實現 Diameter 協議

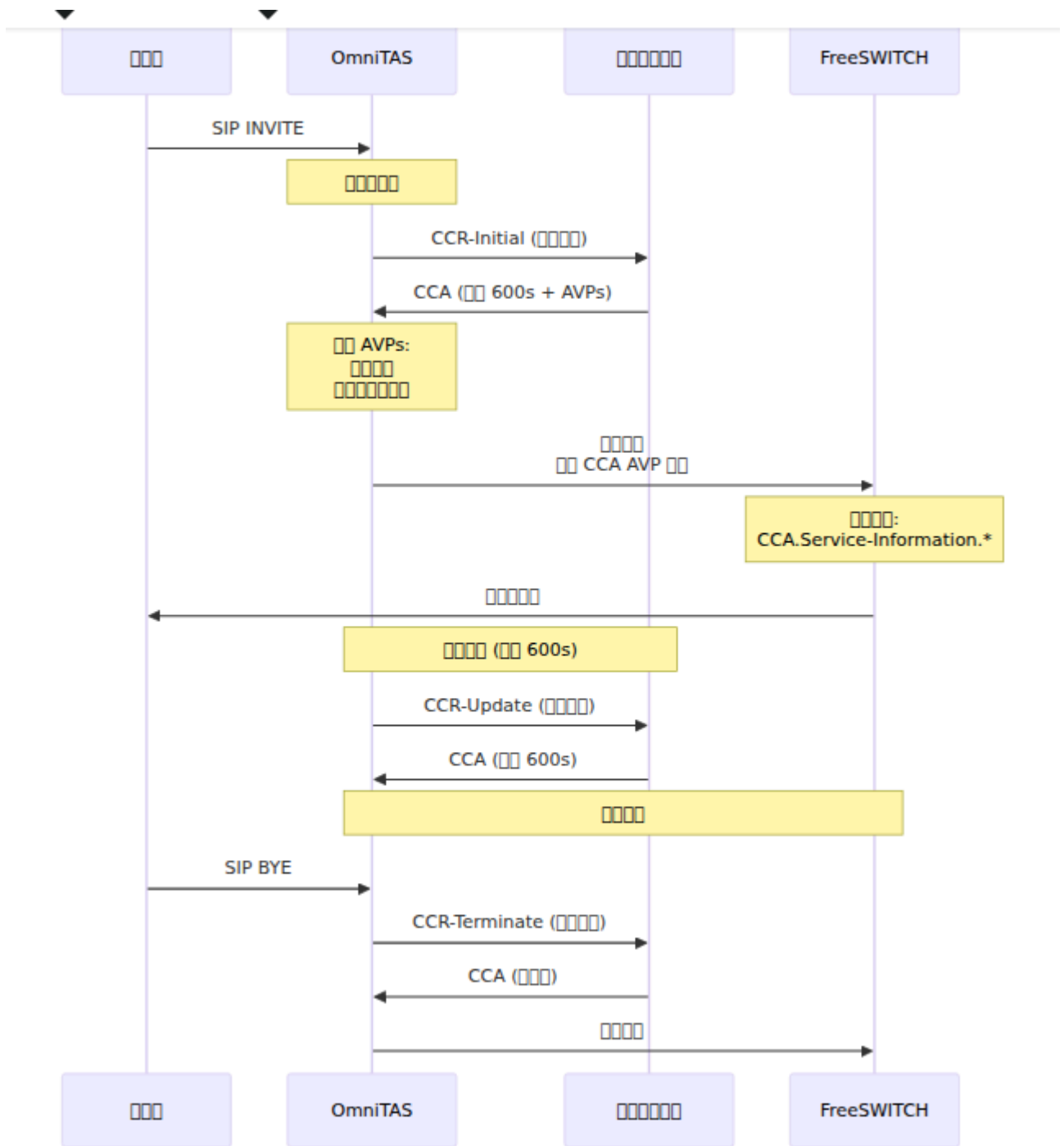

CCRs

CCRs (CCR):

- **CCR-Initial** (1): Initial CCR
- **CCR-Update** (2): Update CCR
- **CCR-Terminate** (3): Terminate CCR

CCAs (CCA):

- 000000000000000000000000
- 00000000 AVPs 0000000000
- 000000000000000000000000

□□□□□□

□□□□□□

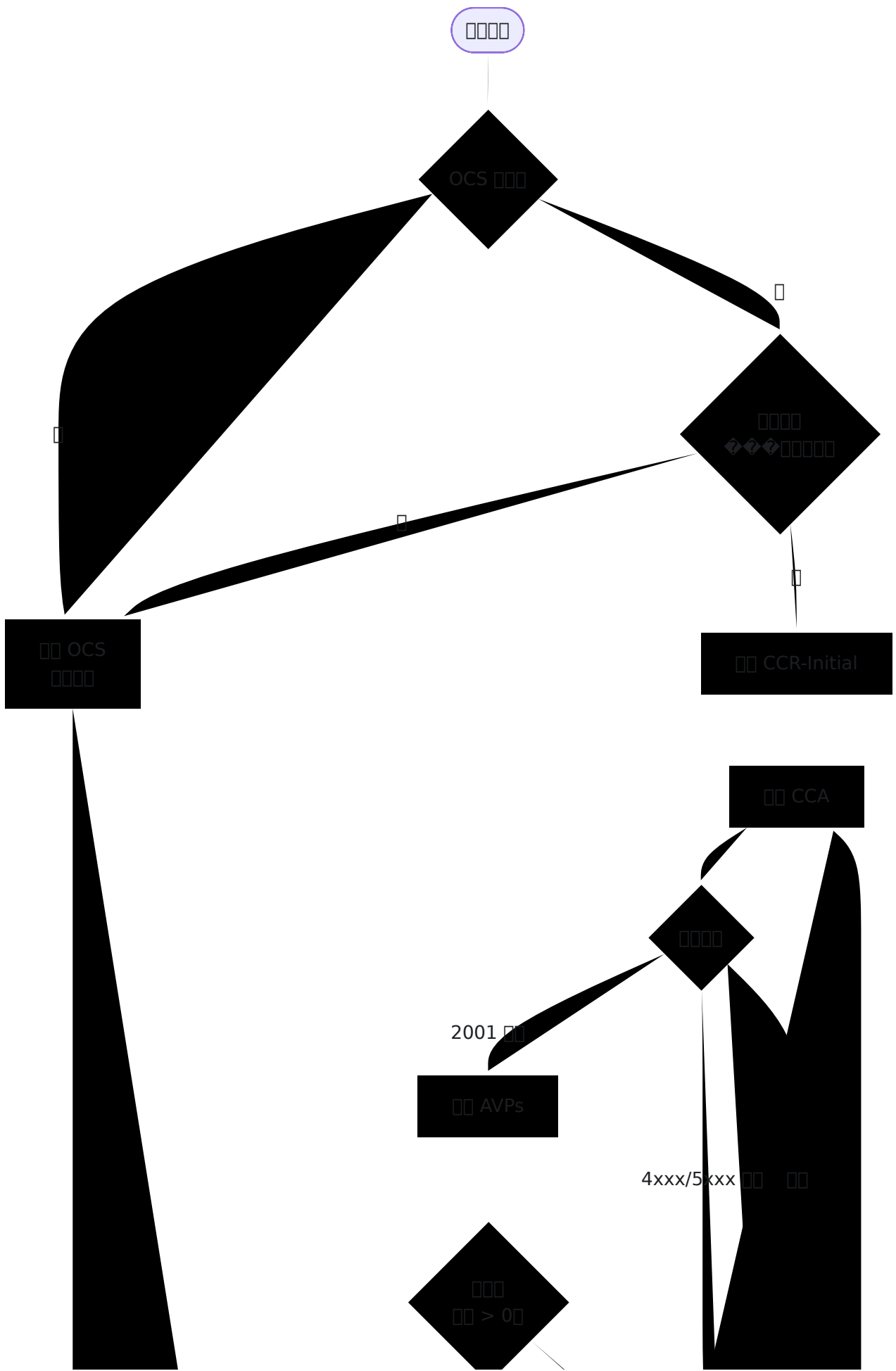

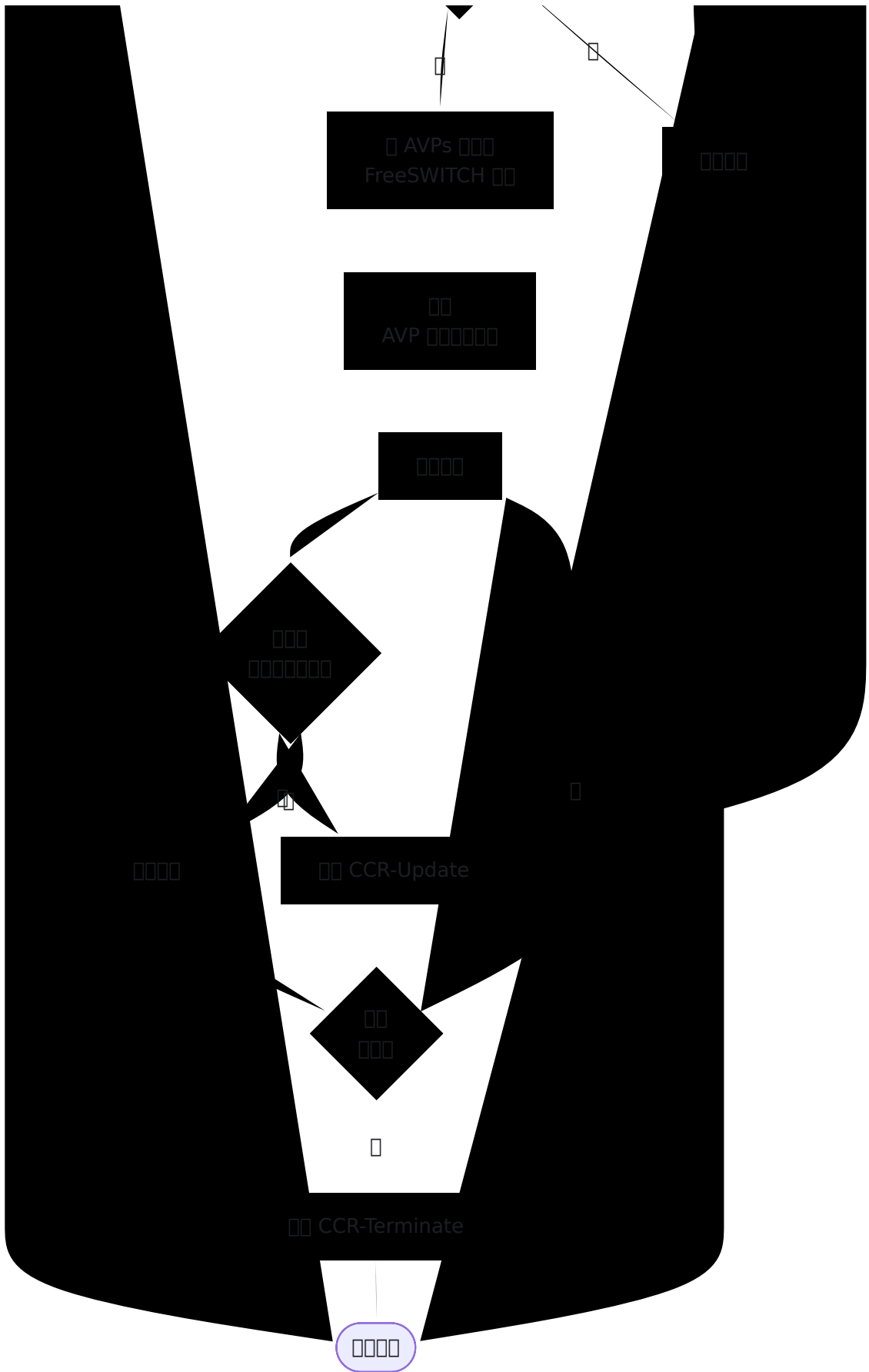

CCR-Terminate

OmniTAS [redacted]

[redacted]

[redacted] `schedule_hangup_auth` [redacted] OmniTAS [redacted] FreeSWITCH [redacted]
[redacted] CCR-Update [redacted]

□□□□

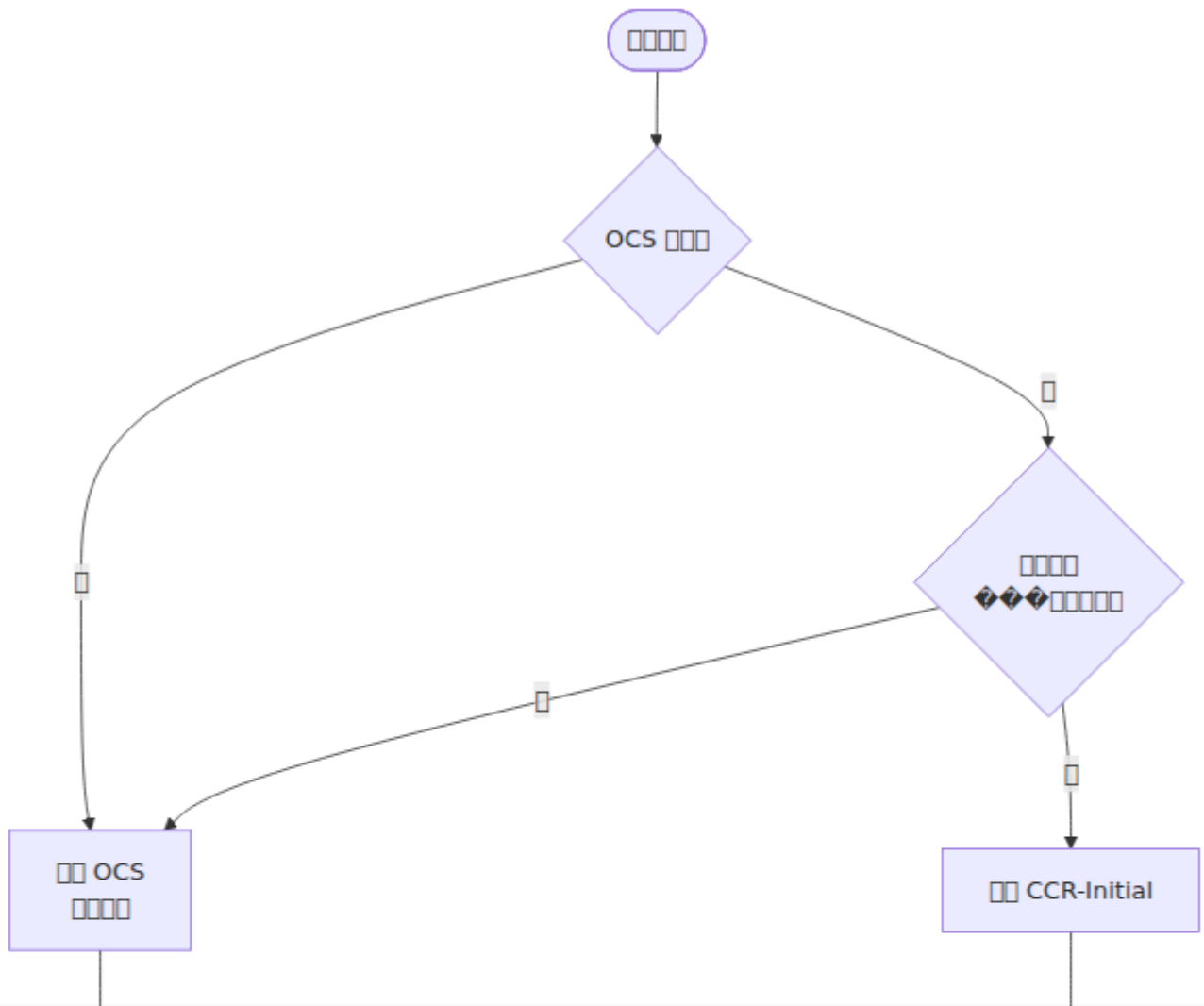

OmniCharge

OmniRAN

Downloads

⌕ [Search Icon]

OmniTouch Website

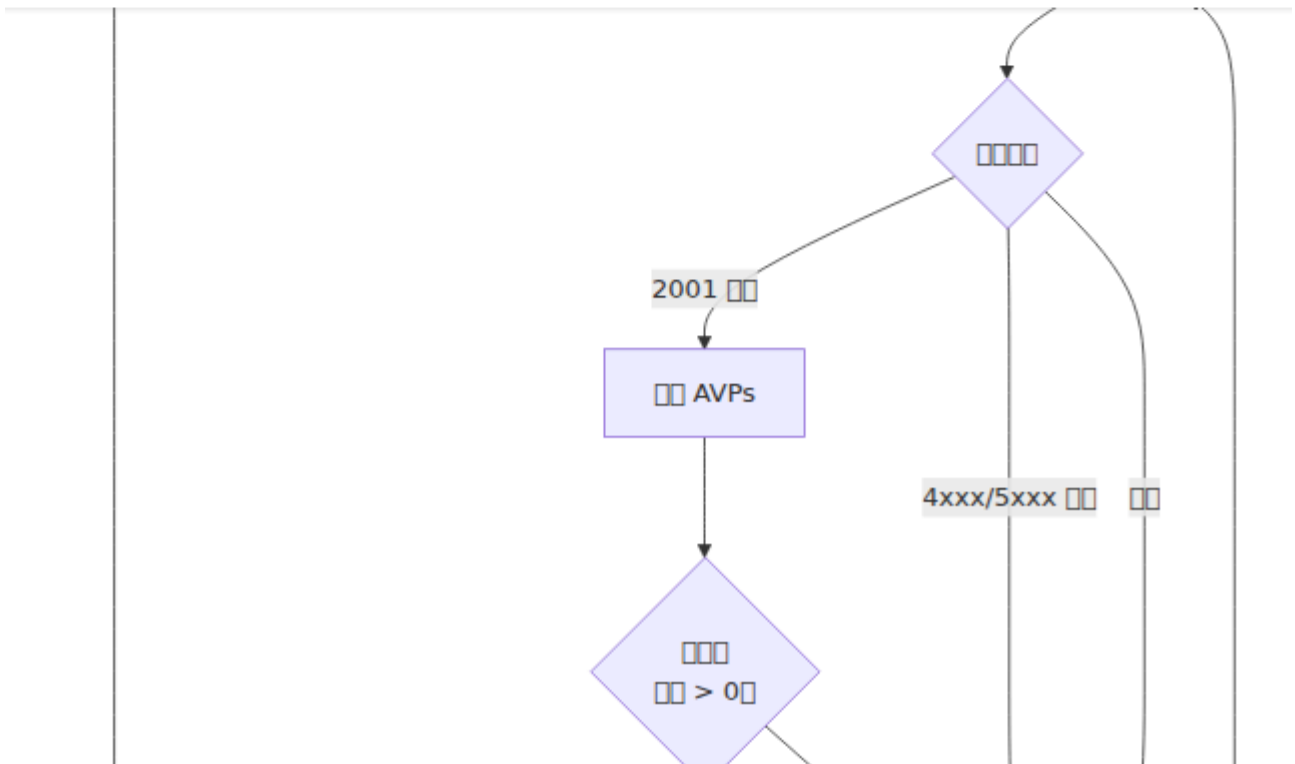

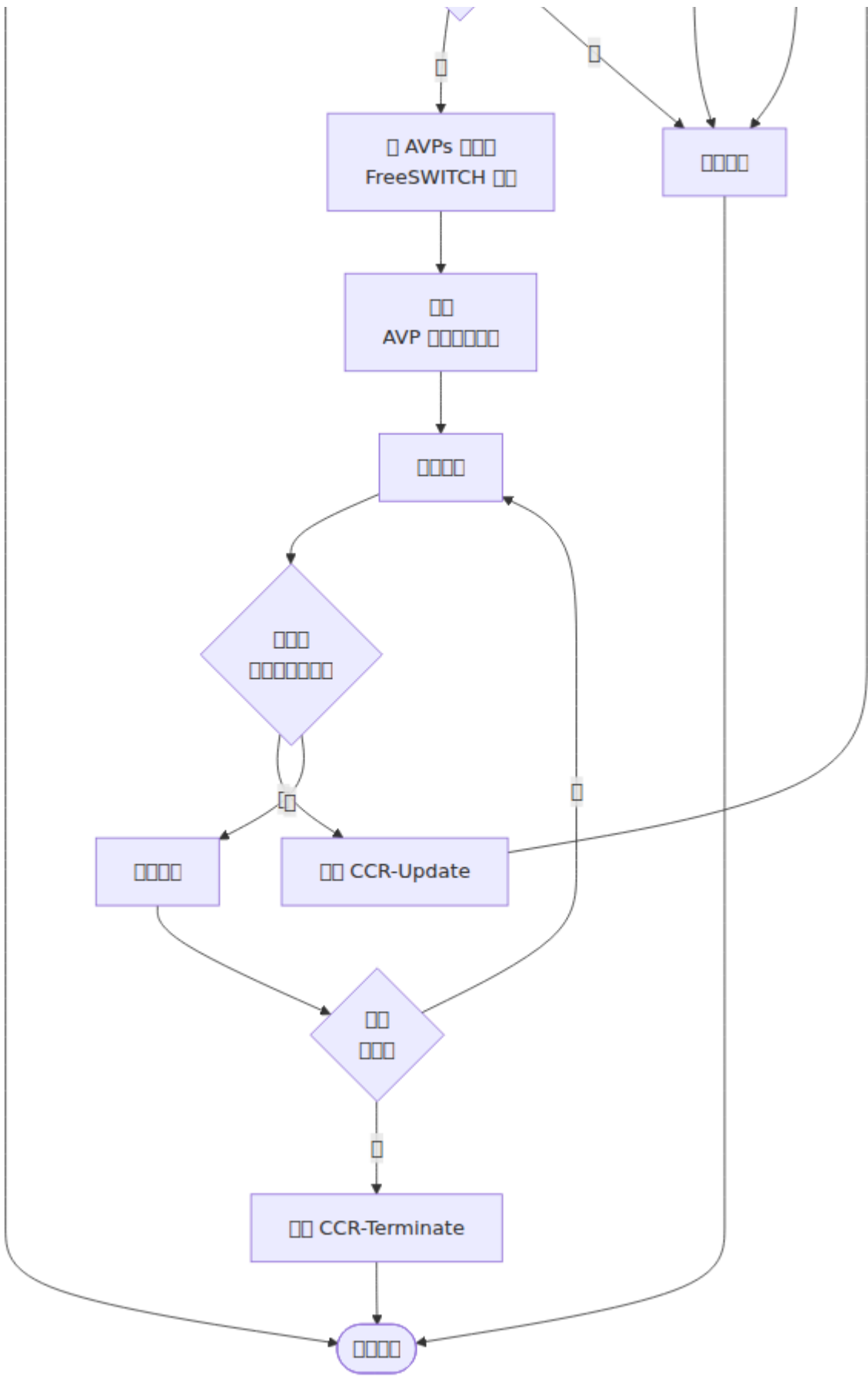

□□□□

OmniTAS CCR-Update

- **T+0s:** OCS 10s T+10s

- **T+8s:** CCR-U 10s - 2s
- **T+8.1s:** OCS 10s T+18.1s 10s
- **T+16.1s:** CCR-U
- **T+16.2s:** OCS 10s T+26.2s
- OCS

```
[OCS HANGUP RESCHEDULE] UUID <uuid> <id> - 10s
[SCHED TRANSFER] 10s credit_exhausted <uuid>
[OCS HANGUP RESCHEDULE] <id> (UUID: <uuid>)
```

schedule_hangup_auth + credit_exhaustion_announcement

OmniTAS

```
config :tas, :online_charging,
  schedule_hangup_auth: true,
  credit_exhaustion_announcement: nil
```

→ sched_hangup -

```
config :tas, :online_charging,
  schedule_hangup_auth: true,
  credit_exhaustion_announcement:
    "${base_dir}/sounds/en/us/callie/misc/8000/credit_exhausted.wav"
```

→ sched_transfer - credit_exhausted

1. OmniTAS tas_call_reason=credit_exhausted

2. 當 credit_exhausted 時 ims_as 會

3. 當

- FreeSWITCH 的 A-leg 會 credit_exhausted
- B-leg 會 BYE
- A-leg 會
-

當

-
- B-leg
- CCR-T
- FreeSWITCH 的 `{base_dir}`

CCR-Update

當 OCS 的 CCR-Update 時 OmniTAS 會

OCS

CCR-Update

CCA

OCS

N
N > 0

0

4012

CREDIT_LIMIT_REACHED

4010

SERVICE_DENIED

+N

credit_exhausted

OUTGOING_CALL_BARRED



□□□□□□□□

OCS □□	□□	□□
<code>{:ok, 0}</code> (□□)	□□□□ □□	□□□□□□□□□□ - □□□□□□
<code>{:error, 4012}</code> (CREDIT_LIMIT_REACHED)	□□□□□ □□	□□□□□4012 CREDIT_LIMIT_REACHED□ - □□□□ □□□
<code>{:error, 4010}</code> (END_USER_SERVICE_DENIED)	□□□□□ □□	□□□□□4010 END_USER_SERVICE_DENIED□ - □□□□□□
<code>{:error, reason}</code> (□□□□)	□□□□□ CCR □ □□□□□ □□□□□	□□□ CCR □□□□□ <reason> - □ □□□
<code>{:ok, N}</code> □□ N > 0	□□□□□ □□□ +N □	□□□ CCA □□ Ns□□□□ (N- buffer)s □□□□□□ CCR-U

□□□: □□□□□□□□ □□ □□□□□□□□□□ OCS □ T+8s □□□□□□□□□□□□□□ T+10s□□□□ T+8s □□□□□□
□□□□□□□□□□□□□□

□□□□□□□□□□□□□□

```
T+0s:   []
T+0.1s: OCS [] 10s → [] T+10.1s
T+8s:   [] CCR-U[] = 2s
T+8.1s: OCS [] 0 [] → [] credit_exhausted []
T+8.2s: []
T+10s:  []
```

[]

```
[warning] [] - []
[warning] [] <id> (UUID: <uuid>)[]
[info] []: "${base_dir}/sounds/..."
[info] []: ...
[info] [] <uuid> [] tas_call_reason=credit_exhausted
[info] []: uuid_transfer <uuid> credit_exhausted XML
ims_as
```

[]

OmniTAS []

1. [] (schedule_hangup_auth):

- []/[]
- [] CCR-U []
- [] CCR-U
- []

2. []:

- [] OCS [] CCR-U []
- []
- []
- [] Diameter []

[] credit_exhaustion_announcement []

AVP 配置

概要

OmniTAS 環境 (AVPs) FreeSWITCH 環境 OCS 環境

AVP 種類:

- UTF8String, Unsigned32, Integer32
- AVPs
- AVPs (3GPP)

CCA: AVPs CCA:

```
CCA.<AVP-001>.<001-AVP-001>.<001-AVP-001> = ""
```

AVP 種類

AVP (3GPP)

AVP (AVP ID 873, ID 10415) IMS

OCS 種類:

```
IMS-001
├── IMS-001
│   ├── 1408
│   └── 6
└── NickTest
```

FreeSWITCH 種類:

```
CCA.Service-Information.Carrier-Select-Routing-Information =  
"1408"  
CCA.Service-Information.Alternate-Charged-Party-Address =  
"NickTest"
```

#####: #####

```
<action application="log" data="INFO ##: ${CCA.Service-  
Information.Carrier-Select-Routing-Information}"/>
```

uuid_dump ##: ## FreeSWITCH ##### ESL ##### `variable_`

```
variable_CCA.Service-Information.Carrier-Select-Routing-  
Information: 1408  
variable_CCA.Service-Information.Alternate-Charged-Party-Address:  
NickTest
```

##: FreeSWITCH #####

AVP

#####

OCS ##:

```
#####  
└─ CC-##: 600
```

##:

```
allocated_time = 600
```

AVP 0000

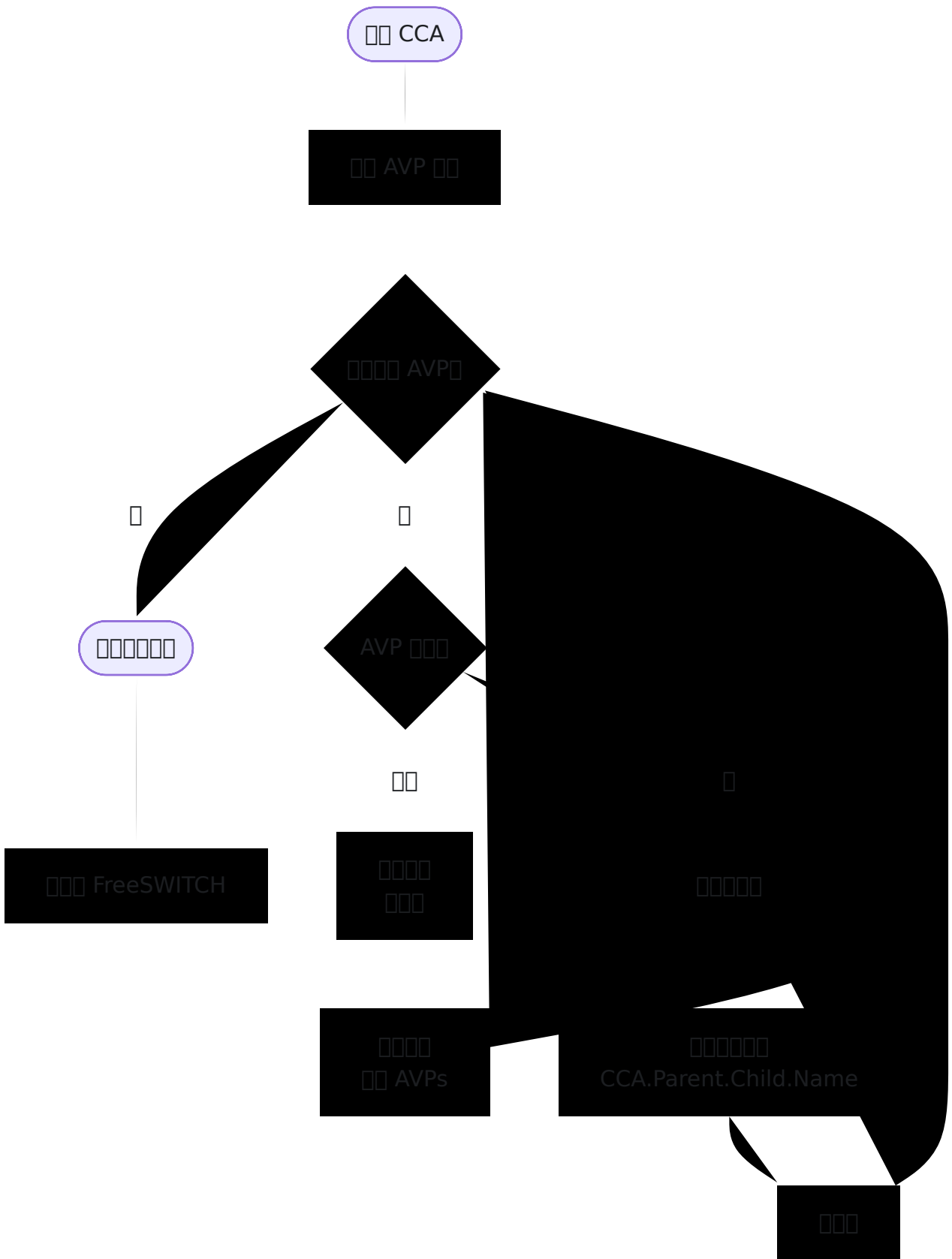

0000:

1. AVPs
2. AVPs
3. AVPs AVPs
4. AVPs

OCS CCA :

```

( )
├── IMS- ( )
│   ├── : 6
│   ├── : 1
│   ├── : "tel:+313380000000670"
│   └── ( )
│       ├── SIP- : "2026-01-24T22:40:18Z"
│       └── SIP- : "2026-01-24T22:40:18Z"
└── IN- ( )
    └── : "24724741234"

```

FreeSWITCH :

```

CCA.Service-Information.IMS-Information.Node-Functionality = "6"
CCA.Service-Information.IMS-Information.Role-Of-Node = "1"
CCA.Service-Information.IMS-Information.Calling-Party-Address =
"tel:+313380000000670"
CCA.Service-Information.IMS-Information.Time-Stamps.SIP-Request-
Timestamp = "2026-01-24T22:40:18Z"
CCA.Service-Information.IMS-Information.Time-Stamps.SIP-Response-
Timestamp = "2026-01-24T22:40:18Z"
CCA.Service-Information.IN-Information.Real-Called-Number =
"24724741234"

```

□□

□□□□□□

□□	□ □	□ □	□□	□□
<code>enabled</code>	□ □ □	□	<code>false</code>	□□□□□□□□□□ <code>false</code> □ OCS □□□
<code>periodic_ccr_time_seconds</code>	□ □	□	<code>60</code>	□□□□□□ CCR-Update □□□□□□□□ <code>schedule_h</code> □□□□□□□□□□□□□□□□□□ □□□□□□□□
<code>ccr_update_buffer_seconds</code>	□ □	□	<code>2</code>	□□□ CCR-Update □□□□ □□□□□□□□ OmniTAS □ (<code>allocated_time - b</code> CCR-U□□□□□□□□□□□□□□
<code>schedule_hangup_auth</code>	□ □ □	□	<code>false</code>	□□□□□□□□□□□□□□□□/□□□ □□□□□□□□□□□□□□□□□□ □□□□□□□□□□□□□□□□□□ <code>allocated_time</code> □□ Fr □□□□□□□□□□□□□□□□□□ <code>credit_exhaustion_a</code> □□□□□□
<code>credit_exhaustion_announcement</code>	□ □ □	□	<code>nil</code>	□□□□□□□□□□□□□□□□□□ <code>schedule_hangup_auth</code> □□ □□ □□□□□□□□□□□□□□ <code>schedule_hangup_auth</code> □□□□□□□□□□□□□□□□□□ F □□□ "□{base_dir}/sou □□ <code>nil</code> □□□□□□□□□□□□□□

Field	Origin	Destination	Host	Realm
skipped_regex	[]	[]	[]	OCS Diameter Regex: "^911\$" "^000\$"

Diameter Fields

Field	Origin	Destination	Host	Realm
origin_host	[]	[]	-	OmniTAS Diameter (FQDN) Diameter Host: "tas01.epc.mnc123.mcc456.3gppnetv"
origin_realm	[]	[]	-	OmniTAS Diameter Host: "epc.mnc123.mcc456.3gppnetwork.o"
destination_realm	[]	[]	-	OCS Diameter
destination_host	[]	[]	nil	OCS Diameter nil destination_realm

配置

```
config :tas, :online_charging,  
  # 是否启用  
  enabled: true,  
  
  # 每 60 秒更新 CCR-Update  
  periodic_ccr_time_seconds: 60,  
  
  # 是否启用  
  schedule_hangup_auth: true,  
  
  # 信用耗尽公告  
  credit_exhaustion_announcement: "ivr/ivr-  
account_balance_low.wav",  
  
  # 跳过正则 OCS  
  skipped_regex: [  
    "^911$",      # 紧急呼叫  
    "^000$",     # 国际长途  
    "^\\*86$"    # 国际漫游  
  ]  
  
config :tas, :diameter,  
  # 源地址  
  origin_host: "tas01.epc.mnc380.mcc313.3gppnetwork.org",  
  origin_realm: "epc.mnc380.mcc313.3gppnetwork.org",  
  
  # OCS 地址  
  destination_realm: "epc.mnc380.mcc313.3gppnetwork.org",  
  destination_host: nil # 不指定主机名
```

配置

配置

- 配置 `skipped_regex` 正则
- 配置 OCS 地址
- 配置 CCR-Initial 的 `destination_realm` 指向 OCS
- 配置 CCA 消息 AVPs

5. AVPs FreeSWITCH AVP
6. allocated_time AVP
7. periodic_ccr_time_seconds CCR-Update
8. schedule_hangup_auth
9. CCR-Terminate

- OCS:
- : periodic_ccr_time_seconds 30s
- : schedule_hangup_auth credit_exhaustion_announcement
- : skipped_regex

FreeSWITCH

AVP

CCA AVP FreeSWITCH

```

<extension name="Route_with_OCS_Data">
  <condition field="destination_number" expression="^(.+)$">

    <!-- OCS OCS OCS -->
    <action application="log"
      data="INFO OCS: ${CCA.Service-Information.Carrier-
Select-Routing-Information}"/>

    <!-- OCS OCS -->
    <action application="log"
      data="INFO OCS: ${CCA.Service-Information.Alternate-
Charged-Party-Address}"/>

    <!-- OCS -->
    <action application="log"
      data="INFO OCS: ${allocated_time} "/>

    <!-- OCS -->
    <action application="set"
      data="carrier_code=${CCA.Service-Information.Carrier-
Select-Routing-Information}"/>
    <action application="bridge"

data="sofia/external/$1@carrier-${carrier_code}.sip.example.com"/>

  </condition>
</extension>

```

○○○○○

○○:

- ○○○ FreeSWITCH ○○○ ○○ ○○
- ○○○○○○○○○○○
- ○○○○○○○○○○○

○○:

- ○○○○○○○○○○○○○○○
- ○○○○○/○○○○○○

- 設定する

設定

1. OCS 設定

OCS 設定

```
<extension name="Carrier_Selection">
  <condition field="${CCA.Service-Information.Carrier-Select-
Routing-Information}" expression="^(.+)$">
    <action application="bridge"
data="sofia/external/${destination_number}@carrier-$1.example.com"/>
  </condition>

  <!-- コメント -->
  <condition field="${CCA.Service-Information.Carrier-Select-
Routing-Information}" expression="^$">
    <action application="bridge"
      data="sofia/external/${destination_number}@default-
carrier.example.com"/>
  </condition>
</extension>
```

設定: OCS AVP "1408" FreeSWITCH 設定 `carrier-1408.example.com`

2. 設定

OCS 設定

```

<extension name="Alternate_Billing">
  <condition field="{CCA.Service-Information.Alternate-Charged-Party-Address}" expression="^(.+)$">

    <!-- CDR -->
    <action application="set"
      data="billed_party=$1"/>
    <action application="export"
      data="billed_party=$1"/>

    <!-- SIP -->
    <action application="set"
      data="sip_h_X-Billed-Party=$1"/>

    <action application="bridge"

data="sofia/external/${destination_number}@trunk.example.com"/>
  </condition>
</extension>

```

OCS OmniTAS AVP "NickTest" CDR SIP

3.

```

<extension name="Credit_Warnings">
  <condition field="destination_number" expression="^(.+)$">

    <!-- 30 seconds -->
    <action application="set"
      data="warning_time=${expr(${allocated_time} - 30)}/>

    <action application="sched_hangup"
      data="+${allocated_time} ALLOTTED_TIMEOUT"/>

    <action application="sched_broadcast"
      data="+${warning_time} playback::ivr/ivr-
account_balance_low.wav"/>

    <action application="bridge"
      data="sofia/external/$1@trunk.example.com"/>
  </condition>
</extension>

```

Example: OCS `allocated_time` 30 seconds

Diameter

CCR-Initial (1)

AVPs:

AVP	길이	타입	비고
Session-Id	263	UTF8String	원시 호스트 이름; <origin_host>; <timestamp>;<random>
Auth-Application-Id	258	Unsigned32	4 Diameter 프로토콜 RFC 4006
Service-Context-Id	461	UTF8String	"000.000.12.32260@3gpp.org" IMS 프로토콜 TS 32.299
CC-Request-Type	416	타입	1 (INITIAL_REQUEST)
CC-Request-Number	415	Unsigned32	1
Subscription-Id	443	타입	MSISDN IMSI
Requested-Service-Unit	437	타입	
Service-Information	873	타입	IMS 프로토콜/서비스 정보

CCR-I:

```

Session-Id: "tas01.example.org;1769294418268;8a078232"
Auth-Application-Id: 4
CC-Request-Type: 1 (INITIAL_REQUEST)
CC-Request-Number: 1
Subscription-Id:
  - Subscription-ID-Type: 0 (END_USER_E164)
    Subscription-ID-Data: "313380000000670"
Requested-Service-Unit:
  - CC-Time: 0 (000000)
Service-Information:
  - IMS-Information:
    - Calling-Party-Address: "tel:+313380000000670"
    - Called-Party-Address: "tel:+24724741234"
    - Node-Functionality: 6 (AS)

```

CCA (000000)

00 OCS 000000000000000000

00000 AVPs:

AVP	00	00	00
Result-Code	268	Unsigned32	2001 0000000000000000 00000
Granted-Service-Unit	431	00	0000000000000000
Service-Information	873	00	000000000000000000

00 CCA 0 AVPs:

CCR-Terminate (0000 3)

000000000000000000000000

00 AVPs:

- CC-Request-Type: 3 (TERMINATION_REQUEST)
- Used-Service-Unit: 00000000
- Termination-Cause: 00000000

0000

00	00	00	OmniTAS 00
2001	DIAMETER_SUCCESS	000 0	00 AVPs000000
4010	DIAMETER_END_USER_SERVICE_DENIED	000 000 00	00000000 CALL_REJECTED
4012	DIAMETER_CREDIT_LIMIT_REACHED	000 0	00000000 OUTGOING_CALL_BAR
5003	DIAMETER_AUTHORIZATION_REJECTED	OCS 000 0	0000000000
5xxx	000000	OCS 000 000 0	0000000000

00: RFC 6733 §7.1 0 3GPP TS 32.299



Diameter 过滤器

过滤器: `diameter_requests_total` 指标: 速率 指标: 每秒钟接收到的 Diameter 消息 数量:

- `application` - Diameter 应用: `ro` (漫游)
- `command` - 命令: `ccr`
- `status` - 状态: `success`, `error`, `timeout`

查询:

```
# CCR 速率
sum(rate(diameter_requests_total{application="ro",command="ccr",status="t
[5m]))
  / sum(rate(diameter_requests_total{application="ro",command="ccr"}[
[5m]))

# CCR 错误率
rate(diameter_requests_total{application="ro",command="ccr",status="t
[5m])
```

Diameter 过滤器

过滤器: `diameter_responses_total` 指标: 速率 指标: 每秒钟接收到的 Diameter 消息 数量:

- `application` - `ro`
- `command` - `ccr`
- `result_code` - Diameter 结果码 (2001, 4012, ...)

查询:

```
# 平均値を計算
sum by (result_code)
(rate(diameter_responses_total{application="ro"}[5m]))

# 4012エラーの割合 (4012)
rate(diameter_responses_total{application="ro",result_code="4012"}
[5m])
```

OCS 監視

メトリック: `ocs_authorizations_total` ユニットの単位: OCS 承認の総数

- `result` - `success`, `nocredit`, `timeout`, `error`
- `skipped` - `true` (スキップされた) `false` (スキップされなかった)

例:

```
# 成功した承認の割合を計算
sum(rate(ocs_authorizations_total{result="success",skipped="false"}
[5m]))
/ sum(rate(ocs_authorizations_total{skipped="false"}[5m]))

# 4012エラーの割合
rate(ocs_authorizations_total{result="nocredit"}[5m])
```

Diameter 監視

メトリック: `diameter_request_duration_seconds` ユニットの単位: Diameter リクエストの総数

- `application` - `ro`
- `command` - `ccr`
- `status` - `success`, `error`, `timeout`

例:

```

# CCR 95
histogram_quantile(0.95,

sum(rate(diameter_request_duration_seconds_bucket{application="ro"}
[5m])) by (le)
)

#
avg(rate(diameter_request_duration_seconds_sum{application="ro"}
[5m]))
  by (status)
/
avg(rate(diameter_request_duration_seconds_count{application="ro"}
[5m]))
  by (status)

```

□□□□

FreeSWITCH □□□□ AVP □□

□□:

- FreeSWITCH □□□□□□□ □□ `#{CCA.Service-Information.*}` □□
- □□□□□□□□□□

□❓❓❓□□:

1. OCS □ CCA □□□□□□□ AVPs
2. AVP □□□□□□□□□□
3. □□□□□□ FreeSWITCH □□

□□□□:

1. □□ **OCS** □□□□ **AVPs**

□□ OmniTAS □□□□ CCA □□□□

```
[debug] []: {:diameter_packet, ...}
[debug] [] AVP []: %{
  "CCA.Service-Information.Carrier-Select-Routing-Information"
=> "1408",
  "CCA.Service-Information.Alternate-Charged-Party-Address" =>
  "NickTest"
}
```

[] "[] AVP []" [] %{} [] OCS [] AVPs[]

2. [] **AVP** []

[][]

```
[warning] []: {...}
```

[][] AVP [] Diameter []

3. [] **FreeSWITCH** []

[] FreeSWITCH [] ESL []

```
freeswitch> uuid_dump <call-uuid>
```

[][] variable_ [] CCA. []

```
variable_CCA.Service-Information.Carrier-Select-Routing-
Information: 1408
variable_CCA.Service-Information.Alternate-Charged-Party-
Address: NickTest
variable_CCA.Auth-Application-Id: 4
variable_CCA.Result-Code: 2001
```

[][]: FreeSWITCH []

```
<action application="log" data="消息: ${CCA.Service-Information.Carrier-Select-Routing-Information}"/>
```

消息 "unhandled"

消息:

- 消息: [warning] 消息: :unhandled
- 消息 CCA 消息 (消息 2001) 消息
- 消息 OCS 消息

消息:

- CCA 消息
- 消息 AVPs 消息
- AVP 消息

消息:

消息

消息: 消息

- 消息 AVP 消息 7
- 消息 AVP 消息 []

消息: 消息

- 消息 AVP 消息
- 消息 AVP 消息

消息

- 消息 CCA 消息
- 消息 AVPs 消息 Diameter 消息
- 消息 2001

OCS 配置

配置:

- CCR 配置
- 配置: [debug] 配置: {:error, :timeout}
- 5 配置 CCA

配置:

- OCS/DRA 配置
- 配置 Diameter 配置 (3868)
- destination_realm 配置 destination_host 配置
- OCS 配置

配置:

1. 配置

配置 OCS 配置 TCP 配置

```
telnet ocs.example.com 3868
```

配置

2. 配置 Diameter 配置

配置 destination_realm 配置 OCS 配置

```
config :tas, :diameter,  
  destination_realm: "epc.mnc380.mcc313.3gppnetwork.org" # 配置  
OCS 配置
```

3. 配置 OCS 配置

配置 OCS 配置 CCR 配置 OCS 配置

- 配置 OmniTAS 配置 origin_host 配置 OCS 配置

- OCS 與 OmniTAS 的 ID
- ID 與 OCS 的 ID

安裝步驟

1. 安裝

- 安裝
- `allocated_time` 安裝
- `schedule_hangup_auth` 安裝

2. 配置

- FreeSWITCH 安裝
- `schedule_hangup_auth` 設為 `false`
- 安裝

3. 測試

1. 安裝

安裝 `schedule_hangup_auth`

```
config :tas, :online_charging,
  schedule_hangup_auth: true
```

2. 安裝 FreeSWITCH ESL

安裝 OmniTAS 與 FreeSWITCH 安裝

```
[debug] : {:ok, "+0K"}
```

安裝 FreeSWITCH 安裝

3. 測試

安裝 UUID 安裝

```
[debug] 000000000000600 00
```

000000 UUID0000000000000000

000000000000 **OCS**

00:

- 0000 (911, 000) 0000 OCS 00
- 00 `skipped_regex` 0000000000
- 00000000

0000:

- 000000000000
- 0000000000
- 000000000000

0000:

1. 0000000000

000000000000

```
Regex.compile("^911$") # 0000 {:ok, ~r/^911$/}
```

000000

- 00000000 `^911$` 0000 `911`
- 000000 `*` 000000000000 `*`

2. 00000000

00000000000000000000

```
[debug] 00000000 "911" 0000000000000000...
```

正则表达式 "+1911" 匹配 "^911\$" 正则表达式

3. 正则表达式

```
config :tas, :online_charging,  
  skipped_regex: [  
    "^911$",           # 正则表达式  
    "^000$",           # 正则表达式  
    "^112$",           # 正则表达式  
    "\\*86$",          # 正则表达式  
    "^1?800\d{7}$"    # 正则表达式  
  ]
```

正则表达式

3GPP 正则表达式

正则表达式	正则表达式	正则表达式
TS 32.299	Diameter 正则表达式	§6.3 (Ro 正则表达式), §7.2 (AVP 正则表达式)
TS 32.240	正则表达式	§5 (正则表达式)
TS 29.229	Cx 正则表达式 Dx 正则表达式	正则表达式 AVP 正则表达式 IMS 正则表达式

IETF RFCs

RFC	正则表达式	正则表达式
RFC 6733	Diameter 正则表达式	§3 (正则表达式), §7 (正则表达式)
RFC 4006	Diameter 正则表达式	§8 (正则表达式)

AVP 一覧

OCs 対応 AVPs

AVP 名	長さ	AVP ID	データ型	備考
Session-Id	263	0	UTF8String	セッションID
Auth-Application-Id	258	0	Unsigned32	Diameter アプリケーション ID (4 CC)
CC-Request-Type	416	0	enum	1=正常 2=エラー 3=保留
CC-Request-Number	415	0	Unsigned32	リクエスト番号
Result-Code	268	0	Unsigned32	結果コード (2001=成功)
Granted-Service-Unit	431	0	enum	サービス単位
CC-Time	420	0	Unsigned32	セッション時間
Service-Information	873	10415	enum	3GPP サービス情報
IMS-Information	876	10415	enum	IMS サービス情報
Carrier-Select-Routing-Information	2023	10415	UTF8String	キャリア選択ルーティング情報
Alternate-Charged-Party-Address	1280	10415	UTF8String	代替課金者アドレス

AVP ID 10415 = 3GPP

FreeSWITCH 対応

FreeSWITCH 対応 AVP

項目名	項目	値
<code>{allocated_time}</code>	セッション時間 / CC-時間	600
<code>{CCA.Session-Id}</code>	Session-Id AVP	omni-as01.epc...;1769299669873;
<code>{CCA.Result-Code}</code>	Result- Code AVP	2001
<code>{CCA.Auth- Application-Id}</code>	Auth- Application- Id AVP	4
<code>{CCA.CC-Request- Type}</code>	CC- Request- Type AVP	1
<code>{CCA.CC-Request- Number}</code>	CC- Request- Number AVP	1
<code>{CCA.CC-Time}</code>	CC-時間 AVP セッション時間	600
<code>{CCA.Origin-Host}</code>	Origin-Host AVP	ocs01.epc.mnc380.mcc313.3gppnet
<code>{CCA.Origin-Realm}</code>	Origin- Realm AVP	epc.mnc380.mcc313.3gppnetwork.c
<code>{CCA.Service- Information.Carrier-}</code>	Service- Information → Carrier-	1408

属性名	属性値	属性タイプ
Select-Routing-Information}	Select-Routing-Information	
`\${CCA.Service-Information.Alternate-Charged-Party-Address}`	Service-Information → Alternate-Charged-Party-Address	NickTest

属性:

- CCA AVPs 属性 CCA.
- AVPs 属性 CCA.Parent.Child
- 属性
- `uuid_dump` 属性 `variable_` 属性

属性 `uuid_dump` 属性:

```
variable_allocated_time: 600
variable_CCA.Service-Information.Carrier-Select-Routing-Information: 1408
variable_CCA.Service-Information.Alternate-Charged-Party-Address: NickTest
variable_CCA.Result-Code: 2001
```

□□□□

□ □□□□

□□□□□□□□□□□□□□□□□□□□□□□□

□□□□

□□□□

- □ **□README** - □□□□□□□
- □ □□□□ - □□□□□□
- □ □□□□ - Prometheus □□□□□

□□□□□□□

- □ **□HLR**□□□□□ - HLR□□□□□□□□□□
- □ **□IMS**□□□□□ - □□□□□□□
- □ □□□□□□ - □□□□□□□□

□□□□□□□

- □ □□□□□□ - □□□□□□□□□□□
- □ **□Sh**□□ - □□□□□□□
- □ □□□□ - OCS □□
- □ □□□□ - □□□□□□
- □ □□□□ - □□□□□□

□□□□

- □ **□SS7 MAP** - HLR/MAP □□
- ⚙ □□□□ - □□□□□□□□
- □ **□HOMER**□□ - SIP □□□□□□□

□□

□□□□ OmniTAS □□□□□□□□□□□□□□□□

□□

- □□□□
- □□□□□ (CDR)
- □□□□□
- IMS□□□□□
- □□□□
- Diameter□□□□
- □□□□□
- □□□□□
- □□□□□
- HLR/MAP□□
- □□□□

□□□□□

□□□□□□□□□□ Sofia SIP □□□□□□ IMS □□□□□□□□□□

□□ □□□□□□□□ `/subscribers`

□□

- □□□□□ □□□□□□□□□□□□
- □□□□□ □□□□□□□□□□□□□□□□
 - SIP □□□□□
 - □□ URI
 - □□□□□□□□□□
 - □□□□□IP□□□□□□□□□□
 - □□□□□□□
 - □□□□□□□□□□ P-Access-Network-Info □□□□

- MCC/MNC TAC/LAC ID
-
- OpenStreetMap OpenCellID

Sofia SIP REGISTER P-Access-Network-Info OpenCellID

- -
 -
 -
-

- 0000000000/0000000000
- 00000000000000
- 0000000000
- 000000000000=00000=00000=0000
- 00 UUID A-leg B-leg
- 0000000000
- 000000000000000000
- 00000000000
 - 0 000 NORMAL_CLEARING
 - 0 0000000000
 - 0 0000000000
- 0000 00000000000000
- 0000000 0000000000000000

0000

1. 000000

- 00000000 100 0 CDR 0000 start_stamp 000000
- 000000000000
- 00 0000 / 0000 00000000
- 000000000000000000

2. ???00000

- 00000000 "Columns" 00
- 00000000000000
- 00/000000000000/0000
- 00 "Select All" 0 "Deselect All" 00000000
- 00000000000000
- 000000000000

3. 000000

- 0000000000000000
- 00000000000▼

- 查詢 CDR 資料
- 查詢時間範圍
- 查詢號碼
- 查詢狀態
- 查詢原因

查詢條件

查詢時間範圍

查詢號碼

查詢狀態 CDR 查詢 查詢原因

- caller_id_number
- destination_number
- uuid
- caller_id_name
- hangup_cause

查詢條件

1. 查詢時間範圍

- 查詢 term 查詢
- 查詢時間 查詢
- SQL 查詢 LIKE '%term%' OR
- 查詢 61480 查詢 "61480123456" "55561480999" 查詢

2. 查詢號碼

- 查詢 "term" 查詢
- 查詢時間 查詢
- SQL 查詢 = 'term' OR
- 查詢 "911" 查詢 "911" "9115" "1911"

3. 查詢原因

- `term` 検索
- 検索結果を絞り込む
- SQL `NOT LIKE '%term%'` AND
- `!NORMAL` "NORMAL" 検索

4. 検索/絞り込み

- `"term"` 検索 + 絞り込み
- 検索結果を絞り込む
- SQL `!= 'term'` AND
- `!NORMAL_CLEARING` "NORMAL_CLEARING" 検索

5. 検索 AND

- `term1 AND term2` 検索 AND
- 検索結果を絞り込む
- 検索結果を絞り込む!
- SQL AND 検索
- `"911" AND "12345"` 検索 "911" "12345" 検索

検索結果

```

検索 CDR 検索
検索結果 !
- 検索 **検索結果/検索** 検索 → 検索 TRUE 検索
- SQL field1 LIKE '%term%' OR field2 LIKE '%term%' OR ...

検索 (!)
- 検索 **検索結果/検索** 検索 → 検索 TRUE 検索
- SQL field1 NOT LIKE '%term%' AND field2 NOT LIKE '%term%'
AND ...

AND 検索
- 検索結果
- 検索結果 TRUE → 検索 TRUE 検索
- SQL (term1_conditions) AND (term2_conditions) AND ...

```

検索結果

SQL	MySQL	Oracle
61480	WHERE 61480	WHERE ID = '61480' OR SYS_GUID() = 1
"911"	WHERE '911'	WHERE '911' = 1
!NORMAL_CLEARING	WHERE !NORMAL_CLEARING	WHERE 'NORMAL_CLEARING' = 1
!"NORMAL_CLEARING"	WHERE !"NORMAL_CLEARING"	WHERE 'NORMAL_CLEARING' = 1
"911" AND "12345"	WHERE '911' AND '12345'	WHERE '12345' = '911'
!NORMAL AND 61480	WHERE !NORMAL AND 61480	WHERE '61480' = 1
!"ANSWER" AND !NORMAL	WHERE !"ANSWER" AND !NORMAL	WHERE 'NORMAL' = 1
61480 AND !NORMAL_CLEARING	WHERE 61480 AND !NORMAL_CLEARING	WHERE '61480' = 1

SQL

- WHERE 61480123456 - WHERE 1
- WHERE '911' - WHERE '911' = 1
- WHERE !NORMAL_CLEARING - WHERE 1
- WHERE '61480123456' AND !NORMAL - WHERE 1
- WHERE !test AND !demo - WHERE 1
- WHERE 61480 AND !"ANSWER" AND !CANCEL - WHERE 1

SQL

CDR 数据库 TAS CDR SQLite 数据库

数据库数据库数据库数据库数据库

CDR 数据库

数据库 CDR 数据库数据库数据库数据库数据库数据库数据库数据库

CDR 数据库数据库数据库数据库数据库数据库数据库数据库数据库数据库 **CDR** 数据库数据库数据库数据库

- CSV数据库数据库
- JSON数据库 API 数据库
- XML
- 数据库数据库
- 数据库数据库

数据库数据库数据库数据库数据库数据库数据库数据库数据库数据库 CDR 数据库

数据库

- 数据库数据库 数据库 UUID 数据库数据库数据库
- 数据库数据库数据库数据库数据库
- 数据库数据库数据库数据库数据库
- 数据库数据库 数据库 "911" 数据库数据库数据库
- 数据库数据库数据库数据库数据库数据库
- 数据库数据库数据库数据库数据库数据库
- 数据库数据库数据库数据库数据库数据库
- 数据库数据库数据库 数据库 **!NORMAL_CLEARING** 数据库数据库数据库
- 数据库数据库数据库数据库数据库数据库数据库

数据库

数据库

数据库数据库 `config/runtime.exe` 数据库 `cdrs_field_list` 数据库 LiveView 数据库数据库数据库

CDR 数据库

□□□□

□□□□□

1. □□□□□□□□□□
2. □□□□□□□□□□□□
3. □□□□□□□□□□□□□□
4. □□□□□□□□□□

□□□□

1. □□□□ AND □□□□□□□
2. □□□□□□□□□□
3. □□□□□□□□
4. □□□□□□□□

□□□□

1. □□□□□□□ □□□□□□□
2. □□□□□□□□□□□□□□ □□□□□
3. □□□□□□□□□□□□
4. □□□□□□□□ AND □ OR□

□□

- □□□□ □□□□□□□□□□□□□□□□□□□□□□
- □□□□□□ □□□□□□ + □□□□ + □□□□□□□□□□□□
- □□□□□□□□ □□□□□□□□□□□□□□□□□□□□□□
- □□□□□□□□□ □□□□□□□□□□□□□□□□□□□□□□□□□□□□
- □□□□□□□□ □□□□□□□□□□□□□□□□□□□□□□
- □□□□□□ □□□□□□□□□□□□□□□□□□□□□□□□□□□□
- □□□□□□ □□□□□□□□□□ - □□□□□□□□□□□□
- □□□□□□□□□□ □□□□□□□□□□□□□□□□□□□□□□□□□□
- □□□□□□□□ □□□□□□□□□□□□□□□□□□□□□□□□□□□□
 - □□□□□□□□□□□□ "911"
 - □□ ! □□□□□□ !NORMAL_CLEARING
 - □ AND □□□□ "61480" AND !NORMAL

- 呼叫 注册/鉴权 - 鉴权注册
-

呼叫注册

呼叫注册/鉴权注册

呼叫 注册/鉴权注册 `/calls`

注册

- 鉴权注册 注册/鉴权注册
 - 鉴权注册 注册/鉴权注册
 - **UUID**注册 注册 A-leg 注册 B-leg 注册
-

IMS注册

IMS注册/鉴权注册 3GPP IMS 注册RFC 4579/RFC 4575/TS 24.147注册/鉴权注册

呼叫 注册/鉴权注册 `/conference`

呼叫 注册/鉴权注册 **IMS注册/鉴权注册**

注册

- 鉴权注册 注册/鉴权注册
- 鉴权注册
 - 鉴权注册
 - 鉴权注册
 - 鉴权注册
 - 鉴权注册
 - 鉴权注册MNC/MCC注册/鉴权注册
- 鉴权注册 注册/鉴权注册
 - 注册 ID 注册 SIP URI
 - 鉴权注册
 - 鉴权注册

- **IMS Conference**
 - IMS Conference
 - IMS Conference
 - IMS Conference
- **IMS Conference**
 - IMS/Conference
 - IMS/Conference
 - IMS/Conference
- **IMS Conference** IMS Conference 5 IMS Conference

OmniTAS IMS

IMS Conference OmniTAS IMS `ims_conference` IMS

```

ims_conference list # IMS
ims_conference info <conf_id> # IMS
ims_conference stats # IMS
ims_conference lock <conf_id> # IMS
ims_conference unlock <conf_id> # IMS
ims_conference video <conf_id> on|off # IMS
ims_conference record <conf_id> start|stop # IMS
ims_conference add <conf_id> <sip_uri> # IMS
ims_conference remove <conf_id> <uuid> # IMS
ims_conference destroy <conf_id> # IMS

```

IMS

- IMS IMS
- IMS IMS
- IMS IMS
- IMS IMS
- IMS IMS

3GPP IMS

IMS 3GPP IMS IMS

- **TS 24.147** IMS IM IMS

- **RFC 4579** SIP OPTIONS - OPTIONS
 - **RFC 4575** SIP OPTIONS
 - **RFC 5239** OPTIONS
-

OPTIONS

OPTIONS TAS SIP /

OPTIONS /gw

OPTIONS

- OPTIONS
- OPTIONS
- **Ping** SIP OPTIONS ping
- OPTIONS

OPTIONS

- SIP
 - Ping SIP OPTIONS
 - OPTIONS
 - /
 - /
 - ping
-

Diameter

Diameter Sh Ro

OPTIONS /diameter

OPTIONS

- OPTIONS

- 000000 0000 / TAS 00 / TAS 00000
- 00000000 00 / 0000 / 00 / 00 / 00 / 00 / 00 / 00 / 00
- 000000 000000000000000000
- 00/0000 000000000000000000000000
- 000000 000000000000000000
- 00000000 000000000000000000“00 150 000 500 000”0
- 000000 00000000 500 000000
- 00000000 000000000000000000000000
- 00000000 0000000000000000000000

00000

1. 000000

- 00000000 500 0000000000000000
- 000000000000
- 00000000000000
- 0 1 000000

2. 000000

- 0 **"Source"** 0000000000
 - 0000 - 00 TAS 000000000000
 - **TAS** 00 - 0 Elixir 00000
 - **TAS** 00000 - 0 FreeSWITCH/00000000
- 00000000

3. 0000000000

- 0 **"Level"** 0000000000
 - 00 - 00000000000
 - 0000 0 00 - 0000000000
- 0000000000000000000000

4. 00000000

- 0 **"Search logs..."** 00000

- 0000000000000000
- 00000000
- 00000000000000

5. 00/0000

- 00 **"Pause"** 0000000000000000
- "PAUSED" 0000000000
- 000000000000000000
- 00 **"Resume"** 0000000000000000

6. 000000

- 00 **"Clear"** 000000000000000000
- 00 TAS 0000000000
- 000000000000

7. 00000000

- 0000 0 HH:MM:SS.00000000
- 0000 00 TAS 0000000000000000
- 000000 000000000000 [ERROR]0[INFO] 0
- 00/00 00000000000000
- 000 000000000000

000000

項目	種別	説明	備考
項目	種別	説明	FreeSWITCH 項目
項目	種別	説明	項目
項目	種別	説明	項目
項目	種別	説明	項目
項目	種別	説明	項目
項目	種別	説明	項目
項目	種別	説明	項目
項目	種別	説明	Diameter 項目
項目	種別	説明	項目/項目

項目

- 項目 項目
- 項目 項目/項目
- 項目 ID 項目
- 項目 項目
- 項目 TAS 項目 Diameter/Sh/Ro 項目
- 項目 TAS 項目 FreeSWITCH 項目
- 項目 項目
- 項目 項目

項目

- 項目 項目 + 項目 + 項目
 - 項目="TAS 項目" + 項目="項目" + 項目="Diameter" → 項目 Diameter 項目
- 項目 項目
- 項目 項目 - 項目
- 項目 項目 - 項目

- 電話番号を一意に識別するためのIDを生成する
- 電話番号の範囲を指定する
- 電話番号のフォーマットを指定する
- 電話番号の長さ（桁数）を指定する
- 番号 **UUID** を番号 ID/UUID として生成する
- 電話番号の番号 "911" や "emergency" を指定する

オプション

- 電話番号の長さ 500 桁まで指定可能
- 電話番号の範囲 1000 桁まで指定可能
- 電話番号のフォーマットを指定可能
- 電話番号の長さ/範囲を指定可能
- 電話番号の範囲を `:elixir` や `:freeswitch` で指定可能
- 電話番号の範囲を指定可能
- **PubSub** Elixir の Phoenix PubSub を利用可能
- **FreeSWITCH** の ESI を利用可能

インストール

電話番号の OpenCellID を取得するためのインストール

電話番号の範囲を `/cell_towers` に指定する

- 電話番号 電話番号/電話番号
- 電話番号
 - MCC 電話番号
 - MNC 電話番号
 - 電話番号 GSM 電話番号 LTE 電話番号
 - 電話番号
- 電話番号
 - 電話番号
 - 電話番号 OpenCellID 電話番号
 - 電話番号
- 電話番号 電話番号 ID 電話番号

☐☐

- 電話番号
- 電話番号
- 電話番号
- 電話番号
- 電話番号

☐☐☐

電話番号 OpenCellID (<https://opencellid.org/>) 電話番号

☐☐☐☐☐

電話番号

☐☐☐ ☐☐☐☐☐☐☐ `/simulator`

☐☐☐☐☐ ☐☐☐ HLR ☐☐☐☐☐☐☐

☐☐

- 電話番号 ☐☐ MO☐MT ☐☐☐☐☐
- 電話番号

- 認證
- IP 認證 SBC/CSCF
- 認證
- OCS 認證
- 認證
 - 認證
 - Sh/HLR 認證
 - OCS 認證
 - SS7 MAP 認證
 - 認證 XML
- 認證 認證

認證

- 認證
- 認證
- 認證
- 認證
- 認證 OCS/HLR
- 認證

HLR/MAP 認證

SS7 MAP 認證 SRI 認證 PRN 認證

認證 /hlr

認證 HLR 認證

認證

- **SRI** 認證 認證
- **PRN** 認證 認證
- 認證 認證 MAP 認證
- 認證 認證 MSRN MSC 認證

- 000000 00000 MAP 000000

00

- 00 HLR 0000
- 0000000000
- 0000000000000000
- 00 MAP 00000
- 0000000000

OCS 00

000000 OCS 00 Diameter Ro0000000000000000CCR00000

000 0000000000 /ocs_test

00

- 000 **CCR** 000 00 INITIAL UPDATE TERMINATION EVENT 00
- 000000 00000000 ID 0000000000000000
- 00000000 00 SMS0000000000000000000000
- 000000 000000MO0000000000MT0000
- 000000 000000000000000000000000
- 000000 000000 CCA00000000000000

00000

1. 0000000000

- MSISDN 61400123456
- MSISDN 61400987654
- sms call
 - SMS EVENT_REQUEST 4
 - INITIAL_REQUEST 1
- out MO in MT

2. CCR

- CCR
 - 1 – INITIAL_REQUEST -
 - 2 – UPDATE_REQUEST -
 - 3 – TERMINATION_REQUEST -
 - 4 – EVENT_REQUEST - SMS
- 1

3.

- ID
- "New ID" ID
- ID
 - INITIAL_REQUEST 1 1
 - UPDATE_REQUEST 2 2 3 4...
 - TERMINATION_REQUEST 3 N+1

4.

- OCS
-

5.

- "Run CCR"
- CCA AVP
-
-

- **OCS** 프로세스는 Diameter Ro 프로세스
- 프로세스는 프로세스
- 프로세스는 프로세스 INITIAL → UPDATE → TERMINATION
- 프로세스는 프로세스
- 프로세스는 프로세스 OCS
- 프로세스는 프로세스 AVP 프로세스 OCS
- 프로세스는 프로세스 OCS
- 프로세스는 프로세스

프로세스

- 프로세스는 ID 프로세스
- 프로세스 OCS 프로세스
- 프로세스 UPDATE 프로세스
- 프로세스 TERMINATION 프로세스
- 프로세스 UPDATE 프로세스

Sh 프로세스

프로세스 Diameter Sh 프로세스 UDR 프로세스 HSS 프로세스

프로세스 프로세스 /sh_test

프로세스

- 프로세스는 프로세스 20 프로세스
- 프로세스 **HSS** 프로세스 프로세스 HSS 프로세스 Diameter Sh

- 00000000 000000 XML 000000 AVP
- 000000 00 HSS 0000000000 ID
- 000000 0000 Diameter 0000000000

0000

1. 00000000

- 000000 0000 IMS 0000
- 0000 sip:61400123456@ims.mncXXX.mccXXX.3gppnetwork.org
- 000000 tel:+61400123456 00

2. 00000000 0000000000000000

- **RepositoryData (0)** 000000000000
- **IMSPublicIdentity (10)** 00000000
- **IMSUserState (11)** 0000
- **S-CSCFName (12)** 0000 S-CSCF
- **InitialFilterCriteria (13)** iFC 0000
- **LocationInformation (14)** 00000000
- **ChargingInformation (16)** P-Charging 00
- **MSISDN (17)** 0000
- **IMSI (32)** 0000000000
- **IMSPrivateUserIdentity (33)** 00000000
- 00000000...

3. 00000000

- 00 **"Fetch SH Data"** 00 UDR 00
- 0000000000000000 UDA 0000
- 0000000000 XML 00000000 iFC 00
- 000000000000 HSS

00

- 00000000 00000000 HSS 0000
- **iFC** 0000 0000000000000000

- IMS S-CSCF
- P-Charging-Function-Addresses
- **HSS** Diameter Sh
-
- HSS
-

- **IMSPublicIdentity (10)**
- **RepositoryData (0)**
- **IMSUserState (11)**
- **InitialFilterCriteria (13)**
- ID HSS
- Diameter 5001 =

/translate

-
-
-

- 000000 00000000000000
- 000000 000000000000000000

0000

1. 000000

- 000000 000000000000 AU US NZ
 - 0000 config/runtime.exs 0000000000
 - 000000 AU :AU au
- 000000 00000000
 - 0000 +61400111222 0400111222 61400111222
- 0000 00000000000000000000
 - 0000 originate route emergency

2. 000000

- 0000000000
- 000000000000
- 0000 "Translate" 000000
- 000000000000

3. 000000

- 00000 0000000000000000
- 0000 0000000000000000
- 000000000000 000000 Elixir 0000000000

00

- 0000000000 000000000000000000
- 000000 00 E.164 000000000000
- 0000000000 00000000000000
- 0000000000 0000000000000000
- 00000000 00000000000000000000
- 00000000 00000000000000000000
- 00000000 00000000000000000000 SIP 000000
- 00000000 00 MO MT 0000000000

- 0400111222 000 112

00

- 0400111222 000 112 +61400111222
- 000 112
- MO MT
-
-
-
-

000000

00000000000000000000

000 0000000000 /voicemail

00

- 0000000000 00000000000000000000
- 00000000 00000000000000000000
- 000000 00000000000000000000000000
- 000000 00000000000000000000000000
- 000000 00000000000000000000000000
- 000000 00000000000000000000000000

0000

1. 0000000000

- 播放音訊
- 暫停音訊
- 停止音訊
- 重新播放音訊

2. 播放音訊

- 播放音訊時，按 **"▶ Play"** 按鈕
- 播放音訊時，按 **"⏸ Pause"** 按鈕
- 播放音訊時，按 **"⏹ Stop"** 按鈕
- 播放音訊時，按 **"↺ Rewind"** 按鈕

3. 刪除音訊

- 按 **"Delete"** 按鈕
- 按 **"⌫ Backspace"** 按鈕
- 按 **"⌘ + ⌫"** 按鈕

4. 重新播放音訊

- 按 **"Refresh"** 按鈕
- 按 **"↺ Rewind"** 按鈕

音訊格式

音訊格式

- 音訊格式
- **UUID** 音訊格式
- 音訊格式 音訊格式音訊格式音訊格式/音訊
- 音訊格式 音訊格式音訊格式
- 音訊格式 音訊格式
- 音訊格式音訊格式音訊格式

音訊

- 音訊格式 音訊格式音訊格式音訊格式
- 音訊格式音訊格式 音訊格式音訊格式

- [Google Cloud Text-to-Speech API](#)
- [Amazon Polly](#)
- [Microsoft Azure Cognitive Services Text-to-Speech](#)
- [IBM Watson Text to Speech](#)

📄

- [Google Cloud Text-to-Speech API](#)
- [Amazon Polly](#)
- [Microsoft Azure Cognitive Services Text-to-Speech](#)
- [IBM Watson Text to Speech](#)
- [HTML5 Speech API - Web Speech API](#)
- [OpenAI GPT-4o](#)

TTS 📄

📄 [TTS](#)

📄 [/prompts](#)

📄

- [Google Cloud Text-to-Speech API](#)
- [Amazon Polly](#)
- [Microsoft Azure Cognitive Services Text-to-Speech](#)
- [IBM Watson Text to Speech](#)
- [OpenAI GPT-4o](#)

- 音声を生成する際に、音声の品質を向上させるための工夫を行う
- 音声を生成する際に、音声の形式を選択できるようにする

まとめ

1. 音声を生成する

- 音声を生成する際に、音声の品質を向上させるための工夫を行う
 - 音声を生成する際に、音声の形式を選択できるようにする
- 音声を生成する際に、音声の形式を選択できるようにする
- 音声を生成する際に、音声の形式を選択できるようにする

2. 音声を再生する

- 音声を再生する際に、音声の品質を向上させるための工夫を行う
- 音声を再生する際に、音声の形式を選択できるようにする
- 音声を再生する際に、音声の形式を選択できるようにする
- 音声を再生する際に、音声の形式を選択できるようにする
- 音声を再生する際に、音声の形式を選択できるようにする

3. 音声を保存する

- 音声を保存する際に、音声の品質を向上させるための工夫を行う
 - 音声を保存する際に、音声の形式を選択できるようにする
- 音声を保存する際に、音声の形式を選択できるようにする
 - 音声を保存する際に、音声の形式を選択できるようにする
 - 音声を保存する際に、音声の形式を選択できるようにする

4. 音声を削除する

- ▶ 音声を削除する際に、音声の品質を向上させるための工夫を行う
- 音声を削除する際に、音声の形式を選択できるようにする
 - 音声を削除する際に、音声の形式を選択できるようにする
 - 音声を削除する際に、音声の形式を選択できるようにする

5. 音声を再生する

- 音声を再生する際に、音声の品質を向上させるための工夫を行う
- 音声を再生する際に、音声の形式を選択できるようにする
- 音声を再生する際に、音声の形式を選択できるようにする

XML 文件

FreeSWITCH XML 文件

路由 /routing

目录

- 路由模板目录 `priv/templates/` 存放 XML 文件
- 路由模板目录结构
- 路由模板 XML 文件结构
 - 路由模板
 - 路由模板
 - 路由模板/路由
 - 路由模板
- 路由模板目录结构 XML 文件
- 路由模板目录结构
- 路由模板目录结构 600px

目录

1. 路由模板

- 路由模板目录结构 `.xml` 文件
- 路由模板目录结构
- 路由模板目录结构

2. 路由模板

- 000000000000 XML 00
- 0000000000
- 00000000

3. 00 XML 000

- 00000000XML 000000 <extension> 0 <condition>
- 0000000000000000 name= 0 field=
- 000000000000 "public" 0 "destination_number"
- 00000000XML 00 <!-- ... -->

00

- 0000000000 00000000000000
- 0000000000 00000000000000
- 00000000 00000000 XML 00
- 00000000 00000000000000
- 00000000 00000000000000
- 00000000 00000000000000

00

- 000 TAS 00000000 priv/templates/ 00
- 0000 .xml 00
- 00000000000000000000
- 00000000000000000000
- 000000000000000000000000
- 0000000000 XML 00000000
- 0 /logs 00000000000000000000

0000

- 000 00000000 priv/templates/ 000
- 000 FreeSWITCH XML 00000000
- 00000000 0000 .xml 00
- 000 0000000000000000

- 000000 000000000000000000000000
 - 00000000 600px00000000
-

ESL 000000

0000000000 FreeSWITCH 00000000ESL0000

000 0000000000 /command

00

- 000000 0000 ESL/FreeSWITCH API 00
- 000000 0000000000
- 000000 00000000000000 10 0000
- 00000000 000000000000
- 000000 000000000000
- 00000000 0000000000000000 "Run"

0000

1. 000000

- 00000000 ESL 00
- 0000
 - status - 00 FreeSWITCH 00
 - show channels - 00000000
 - uuid_dump <uuid> - 0000000000

- `sofia status` - SIP 狀態
- `reloadxml` - 重新載入 XML 檔案
- `version` - FreeSWITCH 版本

2. 執行

- 執行 **"Run"** 按鈕
- 顯示 "Running..."
- 顯示輸出

3. 輸出

- 顯示 "Output" 欄
- 顯示輸出
- 顯示 "ERROR:" 訊息
- 顯示輸出高度 600px
- 顯示輸出

4. 最近

- 顯示最近
- 顯示 "Recent:" 欄
- 顯示最近 10 個
- 顯示輸出
- 顯示輸出

輸出

コマンド	説明	返り値
<code>status</code>	FreeSWITCHの稼働状況を確認	FreeSWITCHの稼働状況
<code>show channels</code>	現在接続中のチャンネルを確認	チャンネル数 "0 total"
<code>show calls</code>	現在進行中の通話を確認	通話リスト
<code>uuid_dump <uuid></code>	指定したUUIDの通話履歴を確認	通話履歴
<code>uuid_kill <uuid></code>	指定したUUIDの通話を強制終了	"+OK" 返り
<code>sofia status</code>	SIPプロファイルの稼働状況を確認	稼働状況
<code>sofia status profile <name></code>	指定したSIPプロファイルの稼働状況を確認	稼働状況
<code>reloadxml</code>	XML設定を再読み込み	"+OK" 返り
<code>version</code>	FreeSWITCHのバージョンを確認	バージョン情報
<code>global_getvar <var></code>	グローバル変数の値を確認	変数の値
<code>api help</code>	APIコマンドのヘルプを表示	ヘルプ情報

まとめ

- 通話履歴を確認 `uuid_dump` コマンドを使用
- 稼働状況を確認 `status`、`show calls` コマンドを使用
- **SIP** プロファイルの稼働状況を確認 `sofia status` コマンドを使用
- XML設定を再読み込み `reloadxml` コマンドを使用
- 通話を強制終了 `uuid_kill` コマンドを使用
- ヘルプ情報 `api help` コマンドを使用

TTS 開箱

📄 目錄

📄 OpenAI 的 TTS 服務 (TTS) 介紹

📄 安裝

📄 使用

- 📄 **README** - 快速入門
- 📄 安裝 - TTS 服務安裝說明
- 📄 使用 - 如何操作 TTS 服務

📄 其他

- 📄 常見問題 - 常見問題解答
- 📄 貢獻 - 如何為項目貢獻
- ⚙️ 設定 - 配置說明
- 📄 授權 - 許可證

📄 更多

📄 更多相關資源和文章

📄 更多相關資源和文章 `playback` 服務

📄 更多相關資源和文章“`playback`”服務 TTS 服務 OpenAI 服務 openai.fm 服務

```
config :tas,  
  ...  
  prompts: %{\br/>    voice: "alloy",  
    instructions: "Speak with a prim, British accent.",  
    response_format: "wav",  
    recordings: [  
      %{\br/>        text:  
          "You do not have sufficient credit to make that call,  
please topup your service and then try again ",  
        path: "/sounds/en/us/callie/misc/8000/out_of_credit.wav"  
      },  
      %{\br/>        text: "The destination you have called is unable to be  
reached",  
        path:  
"/sounds/en/us/callie/misc/8000/unable_to_be_reached.wav"  
      },  
      %{\br/>        text: "Your call is being transferred to emergency  
services",  
        path:  
"/sounds/en/us/callie/misc/8000/emergency_services_transfer.wav"  
      }  
    ]  
  }  
}
```

Sh

Sh

Sh HSS/Repository

Sh

Sh

- [README](#) -
- [Diameter](#) - Diameter
- [Sh](#) - Sh

Sh

- [Sh](#) - Sh
- [MMTel-Config](#) - MMTel-Config
- [SS7 MAP](#) - HLR Sh

Sh

- [Sh](#) - Sh

Sh

Sh HSS/Repository MMTel

Sh

Sh TAS HSS/Repository Repo 3GPP Diameter

- IMS IMPI/IMPU

- MMTel-Config
-
- S-CSCF

Sh

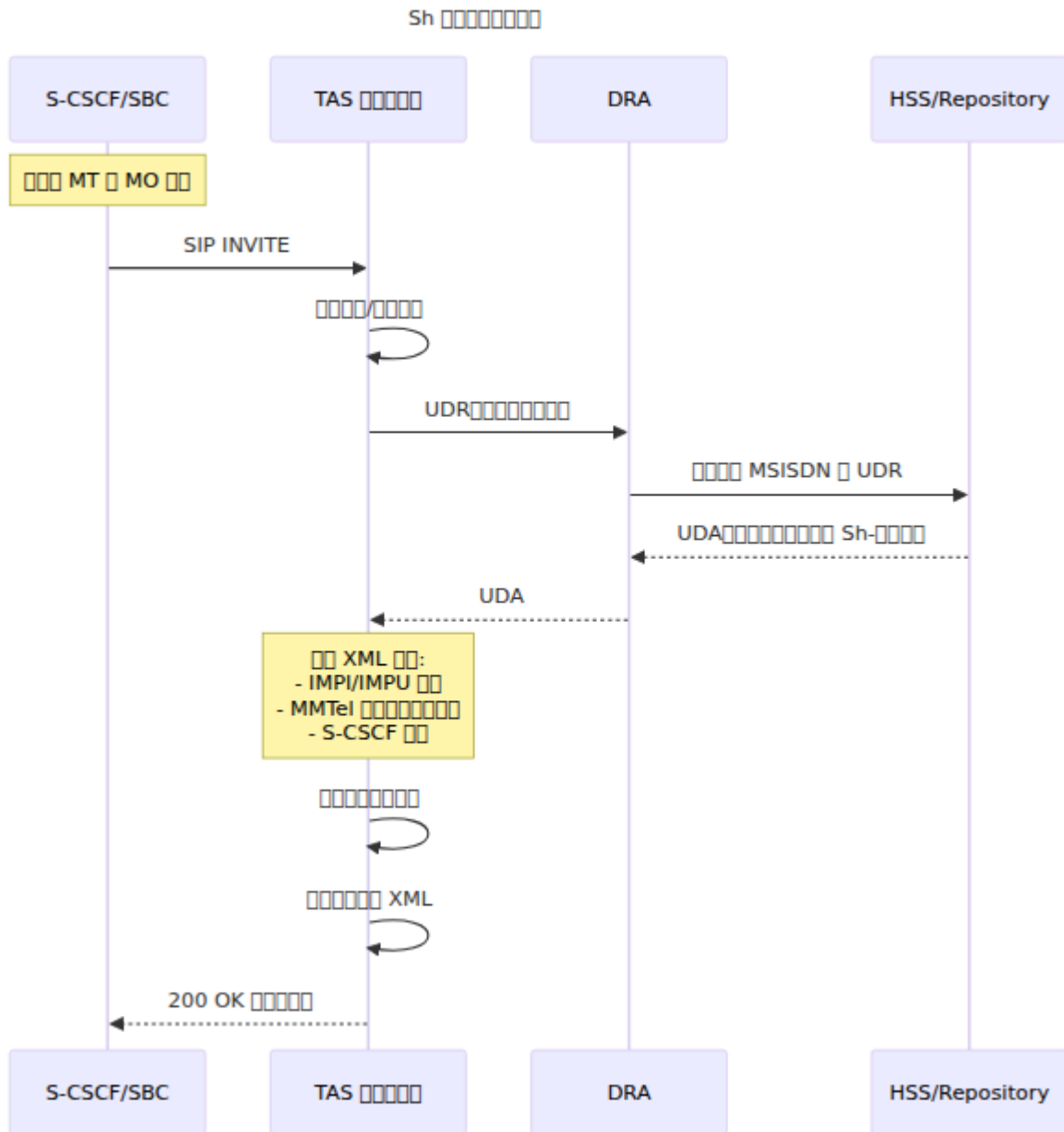

Sh

- MT
- MO
-

Sh

TAS Sh- XML

1. IMS

- **IMPI** `username@domain` -
 - `{IMSI}@ims.mnc{MNC}.mcc{MCC}.3gppnetwork.org`
 - `505014001234567@ims.mnc001.mcc505.3gppnetwork.org`
- **IMPU** `sip:+number@domain` -
 - `sip:+{MSISDN}@ims.mnc{MNC}.mcc{MCC}.3gppnetwork.org`
 - `sip:+61403123456@ims.mnc001.mcc505.3gppnetwork.org`

2. S-CSCF

- S-CSCF
- IMS

3. MMTel

- **CFA**
- **CFB**
- **CFNRy**
- **CFNRc**

MMTel-Config

MMTel-Config HSS/Repository

```
<MMTelSS>
  <CDIV>
    <SS-ActivationState>active</SS-ActivationState>
    <Ruleset>
      <Rule>
        <RuleCondition>communication-diverted</RuleCondition>
        <ForwardTo>+61403555123</ForwardTo>
        <NotificationType>notify</NotificationType>
      </Rule>
    </Ruleset>
  </CDIV>
</MMTelSS>
```

MMTel

- **CDIV** (Call Diversion) - 呼出先の変更
- **OIP** (Outgoing Intercept) - 発信停止
- **TIP** (Termination Intercept) - 着信停止

Sh (Service Home) - サービスホーム

Sh (Service Home) - サービスホーム

項目	項目	値
ims_private_identity	IMPI	505014001234567@
ims_public_identity	IMPU	sip:+61403123456
msisdn	IMPU 番号	61403123456
imsi	IMPI 番号	505014001234567
ims_domain	IMPI/IMPU	ims.mnc001.mcc50
scscf_address	S-CSCF アドレス	scscf01.ims.doma
scscf_domain	S-CSCF ドメイン	ims.domain "no
call_forward_all_destination	MMTel CDIV	61403555123 "no
call_forward_not_reachable_destination	MMTel CDIV	2222
no_reply_timer	MMTel CDIV	30

- `call_forward_not_reachable_destination` `no_reply_timer` `no_reply_timer`
- `no_reply_timer`

Sh

Sh

```
# Sh
rate(subscriber_data_lookups_total{result="success"}[5m]) /
rate(subscriber_data_lookups_total[5m]) * 100

# Sh P95
histogram_quantile(0.95,
  rate(subscriber_data_duration_milliseconds_bucket[5m]))

# Sh
rate(subscriber_data_lookups_total{result="error"}[5m])
```

Sh

- P95 `> 100ms` HSS
- `> 5%` HSS
- `> 20%` HSS

Sh

1. Web UI `Diameter` (`/diameter`)
2. Web UI `Sh` (`/sh_test`)
3. "HSS" `Sh`
4. HSS/Repository `TAS`
5. `subscriber_data_lookups_total`

Sh

Web UI `Sh` (`/sh_test`)

1. `/sh_test`

2. MSISDN +61403123456

3. "Sh"

4.

- IMPI/IMPU
- S-CSCF
- MMTel
-

- HSS
-
- IMS S-CSCF
- HSS

SS7 MAP / Gateway- MSC

📄 [README](#)

📄 HLR 📄 SS7 MAP 📄 MSRN 📄

📄 📄 📄

📄 📄 📄

- 📄 [README](#) - 📄
- 📄 [README](#) - SS7 MAP 📄 `ss7_map` 📄
- 📄 [README](#) - 📄 HLR/MAP 📄

📄 📄 📄 📄

- 📄 [README](#) - 📄 MSRN 📄 `forwarded_to_number`
- ⚙️ [README](#) - 📄 HLR 📄 Sh/MMTel 📄
- 📄 [README](#) - Sh 📄 MAP 📄
- 📄 [README](#) - HLR 📄

📄 📄 📄 📄

- 📄 [README](#) - 📄 HLR/MAP 📄
- 📄 [README](#) - HLR/MAP 📄

Gateway-MSC

TAS 📄 HLR 📄 MSRN 📄 MSC 📄 2G/3G 📄 📄 📄 📄

msrn forwarded_to_number

- enabled - SS7 MAP
- http_map_server_url_base - MAP HTTP API URL
- gmsc - SRI/PRN MSC
- timeout_ms - MAP HTTP 5000

```

config :tas,
  ...
  ss7_map: %{
    enabled: true,
    http_map_server_url_base: "http://10.5.1.216:8080",
    gmsc: "55512411506",
    timeout_ms: 5000 # 5000ms
  },

```

SS7 MAP

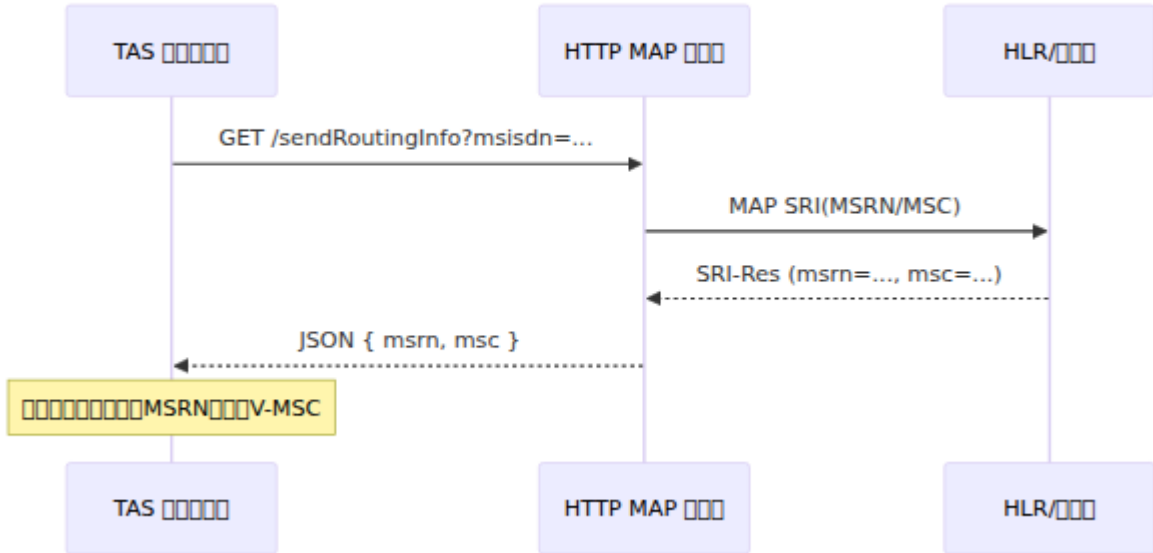

TAS SRI

1. SRI - SRI PRN msrn
2. 2G/3G - VLR PRN V-MSC MSC MSRN
3. -

msrn tas_destination_number PRN

Configuration / CLI / Configuration

CLI configuration / Configuration Sh MMTel-Config configuration

```
config :tas,  
  ...  
  blocked_cli_prefix: ["*67"],  
  call_forward_not_reachable_destination: "2222",  
  default_no_reply_timer: 30,  
  emergency_call_codes: ["911", "912", "913", "sos"],  
  ...
```

Configuration

- **blocked_cli_prefix** configuration CLI ID
 - ["*67"] - *67 ID
 - cli_withheld
- **call_forward_not_reachable_destination** CFNRc
 - Sh MMTel-Config
 - "2222" -
- **default_no_reply_timer** CFNRc
 - Sh MMTel-Config
 - 30 - 30
- **emergency_call_codes**
 -
 - SIP URN <urn:service:sos>
 - ["911", "112", "000", "999", "sos"]
 -

□□□ **ID** □□□□□□□□

TAS □□□□□□□□ ID□CLI □□□□□□□□ cli_withheld □□□□□□□□ "true"□

Call ID 000000

MO 0000
000: *67555123456
00: 00
<sip:+61403123456@domain>

000000

0000
blocked_cli_prefix 00?
(*67, #31#, 00)

OmniCharge

OmniRAN

Downloads

0000

OmniTouch Website

0000000000
*67555123456 →
555123456

cli_withheld = true
(000000)

SIP From 00
00 'anonymous' 00

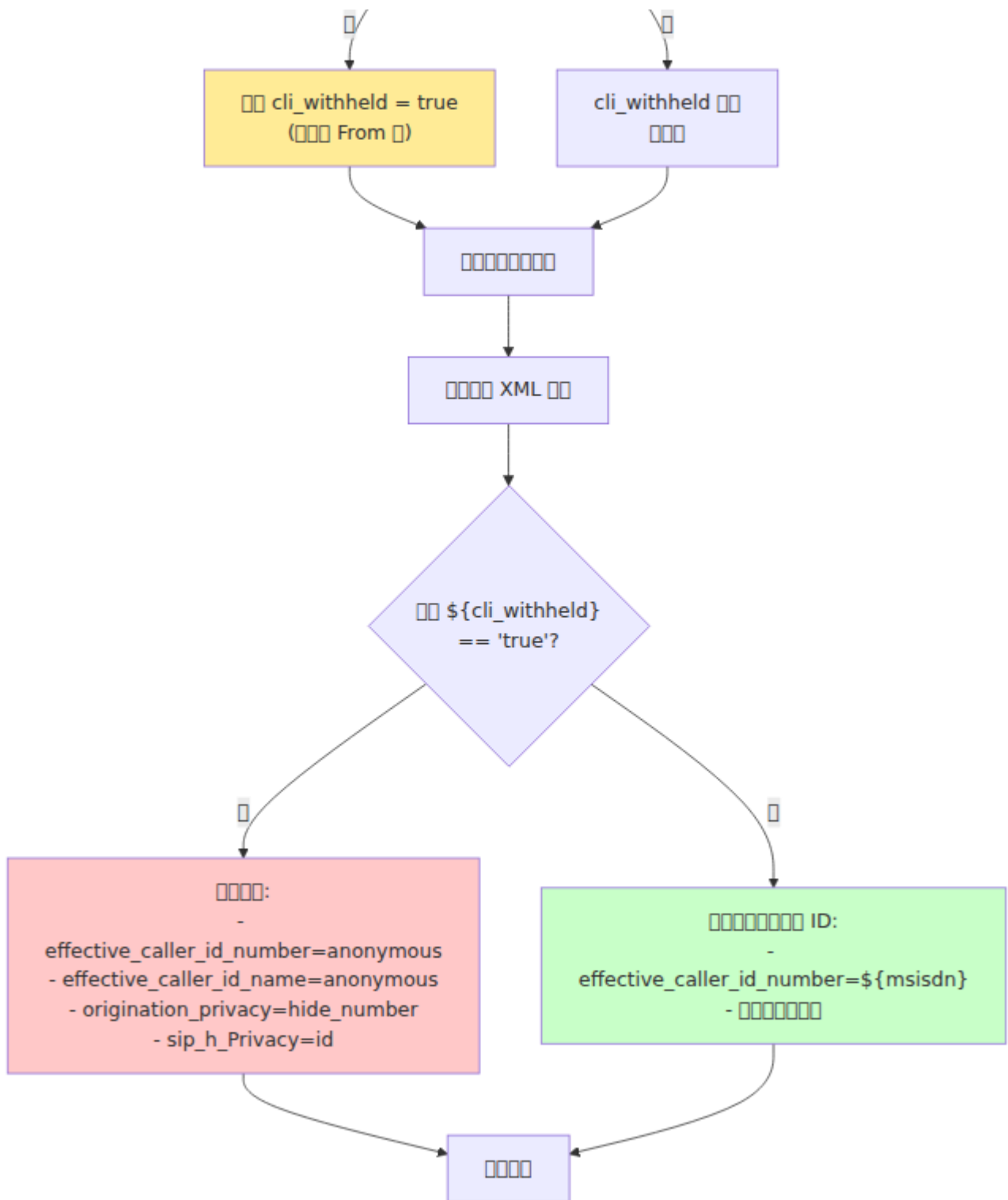

1

blocked_cli_prefix

1. *67555123456
2. 555123456
3. cli_withheld "true"
- 4.

□□□□

```
blocked_cli_prefix: ["*67"] # □□□□□□  
blocked_cli_prefix: ["#31#"] # □□ GSM □□□□  
blocked_cli_prefix: ["*67", "#31#"] # □□□□□□
```

□□ **2** **SIP From** □□□

□ UE/□□□□ SIP □□□□□□

1. TAS □□ SIP From □□□□□□□□ "anonymous"□□◆◆□□□□
2. □□□□ cli_withheld □□□□□□ "true"
3. □□□□□□□□□□□□□□□□

□□□□□□□□ **CLI** □□

TAS `cli_withheld` `XML`

```
<extension name="CLI-Privacy" continue="true">
  <condition field="{cli_withheld}" expression="true">
    <!-- P-Asserted-Identity -->
    <action application="set"
data="effective_caller_id_name=anonymous"/>
    <action application="set"
data="effective_caller_id_number=anonymous"/>
    <action application="set"
data="origination_privacy=hide_number"/>

    <!-- P-Asserted-Identity -->
    <action application="set" data="sip_h_Privacy=id"/>
  </condition>
</extension>
```

TAS `CLI`

TAS `destination_number`

Field	Value	Condition	Description
<code>cli_withheld</code>	<code>"true"</code> / <code>"false"</code>	<code>cli_withheld</code>	From CLI
<code>tas_destination_number</code>	<code>555123456</code>	<code>tas_destination_number</code>	Destination number
<code>destination_number</code>	<code>tas_destination_number</code>	<code>destination_number</code>	Final destination number

`cli_withheld="true"`

`destination_number`

項目	値	説明
effective_caller_id_number	"anonymous"	匿名発信
effective_caller_id_name	"anonymous"	匿名発信
origination_privacy	"hide_number"	SIP 発信者番号非表示
sip_h_Privacy	"id"	SIP RFC 3323 準拠
sip_h_P-Asserted-Identity	(匿名)	P-Asserted-Identity 非表示

匿名発信

```

<extension name="CLI-Privacy-Handler" continue="true">
  <condition field="{cli_withheld}" expression="true">
    <!--  -->
    <action application="log" data="INFO  {tas_destination_number}  CLI  "/>

    <!--  -->
    <action application="set"
data="effective_caller_id_name=anonymous"/>
    <action application="set"
data="effective_caller_id_number=anonymous"/>
    <action application="set"
data="origination_privacy=hide_number"/>

    <!--  SIP  -->
    <action application="set" data="sip_h_Privacy=id"/>

    <!--  P-Asserted-Identity  -->
    <action application="unset" data="sip_h_P-Asserted-Identity"/>

    <!--  cli_withheld  false  -->
    <anti-action application="log" data="DEBUG  ID:
${msisdn}"/>
    <anti-action application="set"
data="effective_caller_id_number=${msisdn}"/>
  </condition>
</extension>

<!--  -->
<extension name="Route-Outbound-Call">
  <condition field="{tas_destination_number}"
expression="^(.+)$">
    <action application="bridge"
data="sofia/gateway/trunk/{tas_destination_number}"/>
  </condition>
</extension>

```

•••••

- SIP
-

1. HLR SS7 MAP [] - []
↓ HLR
2. MMTel-ConfigSh [] [HSS]
↓ MMTel-Config
3. [] [] - []

- **HLR** [] []
- **MMTel-Config** [] IMS []
- [] []

項目	種別	値	単位
call_forward_all_destination	Sh/MMTel なし	"none"	"61403555123"
call_forward_not_reachable_destination	Sh/MMTel なし	"2222"	"2222"
no_reply_timer	Sh/MMTel なし	30	30
msrn	HLR MT	"61400123456"	"61400123456"
tas_destination_number	なし	"2222"	"2222"

XXXXXXXXXXXX

MT XXXXXXXXXXXX

```

<!-- HLR HLR -->
<extension name="Check-CFA" continue="true">
  <condition field="{call_forward_all_destination}"
expression="^(?!none$).+$">
    <action application="log" data="INFO HLR
{call_forward_all_destination}"/>
    <action application="set"
data="tas_destination_number={call_forward_all_destination}"/>
  </condition>
</extension>

<!-- -->
<extension name="Bridge-To-Subscriber">
  <condition field="{msrn}" expression="^none$">
    <!-- MSRNR -->
    <action application="set" data="call_timeout={no_reply_timer}"/>
    <action application="bridge"
data="sofia/internal/{tas_destination_number}@{scscf_address}"/>

    <!-- -->
    <action application="log" data="INFO --"/>

    <!-- -->
    <action application="set"
data="forward_destination={call_forward_not_reachable_destination}"/>
    <action application="log" data="INFO --
{forward_destination}"/>
    <action application="answer"/>
    <action application="voicemail" data="default default
{msisdn}"/>
  </condition>
</extension>

```

HLR

config/runtime.exs HLR

```
config :tas,  
  # CFNRc MMTel-Config  
  call_forward_not_reachable_destination: "2222", #  
  
  # MMTel-Config CFNRy  
  default_no_reply_timer: 30 # 30
```

- HSS MMTel-Config
- Sh
-

1. Sh

- Web UI /sh_test
- MMTel-Config CDIV
- call_forward_all_destination

2.

-
- call_forward_all_destination != "none"
- tas_destination_number

3. HLR SS7 MAP

- Web UI /hlr
- HLR Sh
- msrn

4.

- call_forward_not_reachable_destination
- default_no_reply_timer

- MMTel-Config

```

<!-- -->
<extension name="Prevent-Forward-Loop" continue="true">
  <condition field="{sip_h_X-Forward-Hop-Count}" expression="^$">
    <action application="set" data="sip_h_X-Forward-Hop-Count=1"/>
    <anti-action application="set" data="sip_h_X-Forward-Hop-Count={expr({sip_h_X-Forward-Hop-Count}+1)}/>
  </condition>
</extension>

<extension name="Check-Forward-Hop-Limit">
  <condition field="{sip_h_X-Forward-Hop-Count}" expression="^([3-9]|[1-9][0-9]+)$">
    <action application="log" data="ERROR : {sip_h_X-Forward-Hop-Count}"/>
    <action application="hangup" data="LOOP_DETECTED"/>
  </condition>
</extension>

```

-
- `no_reply_timer`
-

```

INFO 61403555123
INFO 2222
INFO

```

□□□□

- □□□□□□□□□□□□
- □□□□□□□□□□
- □□□□□□□□□□□□

📄📄📄📄📄📄📄📄📄📄

📄 📄📄📄📄

📄📄📄📄📄📄📄📄📄📄📄📄📄📄📄📄

📄📄📄📄

📄📄📄📄

- 📄 📄 **README** - 📄📄📄📄📄
- 📄 📄📄📄 - 📄📄📄📄📄📄📄📄SMS📄📄📄📄
- 📄 📄📄📄 - 📄📄📄📄📄📄📄📄

📄📄📄📄📄

- 📄 📄📄📄📄📄 - 📄📄📄📄📄📄📄📄/📄📄
- ⚙️ 📄📄📄 - 📄📄/📄📄📄📄📄📄📄📄📄
- 📄 **TTS** 📄📄 - 📄📄📄📄📄📄

📄📄📄📄

- 📄 📄📄📄📄 - 📄📄📄📄📄📄📄📄

📄📄

- 📄 📄📄📄📄 - 📄📄📄📄📄📄

📄📄📄📄 / 📄📄📄📄📄📄

📄📄📄📄📄📄 XML 📄📄📄📄📄📄📄📄📄📄📄📄📄📄📄📄📄

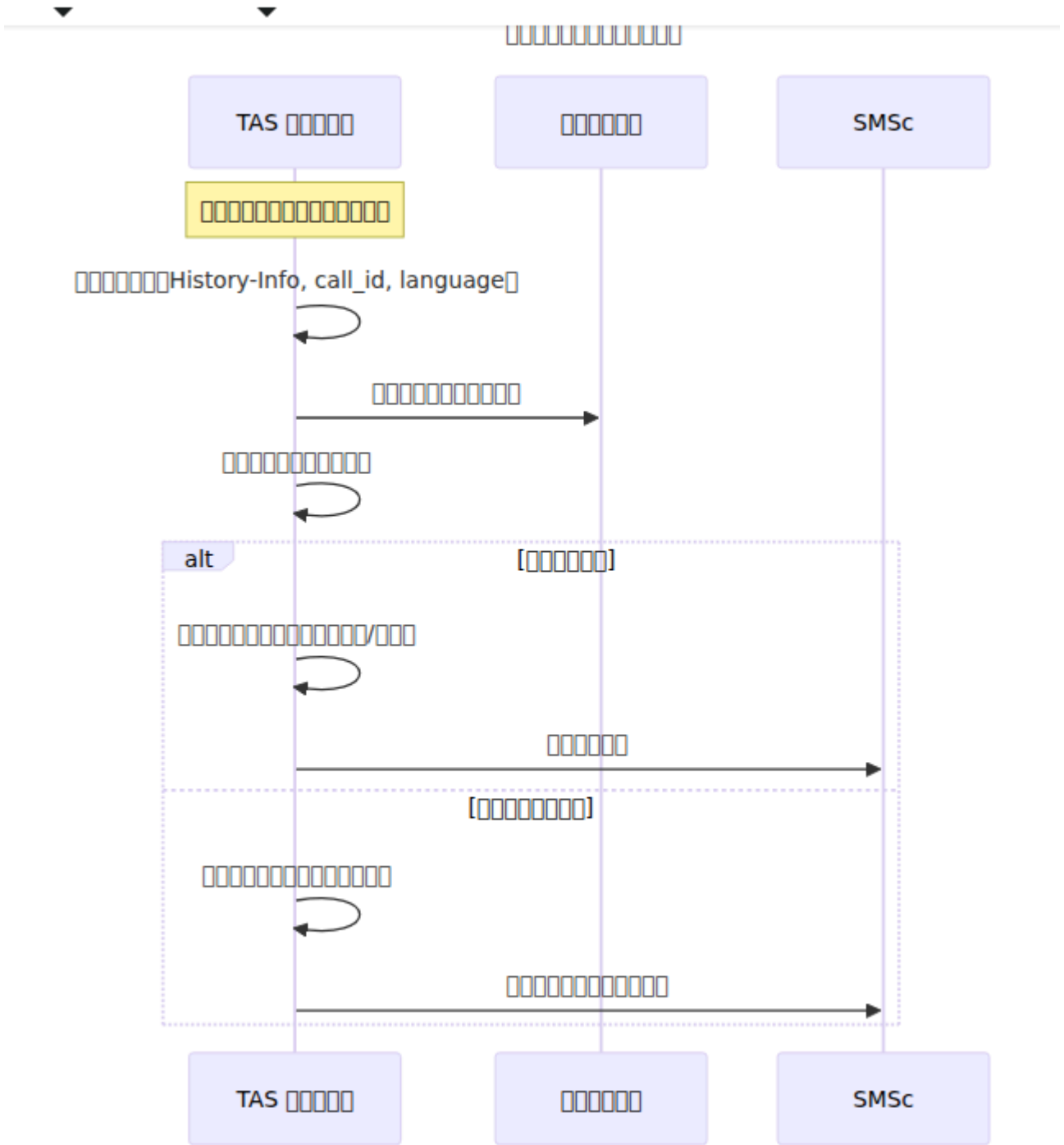

bridge

```

bindings = [
  caller: caller,
  day: day,
  month: month,
  hour: hour,
  minute: minute,
  message_count: message_count
]

```

message_count 1

```

config :tas,
  ...
  voicemail: %{
    timezone: "Pacific/Tahiti", #
    smsc: %{
      smsc_url: "http://10.8.81.215", #SMSc API
      URL
      smsc_api_key: "nicktestkey123", #SMSc
      API
      source_msisdn: "2222" #
    }
  },
  #
  voicemail_notification_text: %{
    not_left:
      "1 <%= caller %> <%= day %>/<%= month %>
<%= hour %>:<%= minute %>",
    single_voicemail:
      "<%= caller %> <%= day %>/<%= month %>
<%= hour %>:<%= minute %> 2222",
    multiple_voicemails:
      "<%= message_count %> 2222"
  }
}

```

